

# Racores universales de ojiva Serie 1000 en latón

Para tubos en plástico, cobre, latón:  $\varnothing$  4, 6, 8, 10, 12 mm  
 Conexiones roscadas: cilíndricas (G1/8, G1/4),  
 cónicas (R1/8, R1/4, R3/8, R1/2)

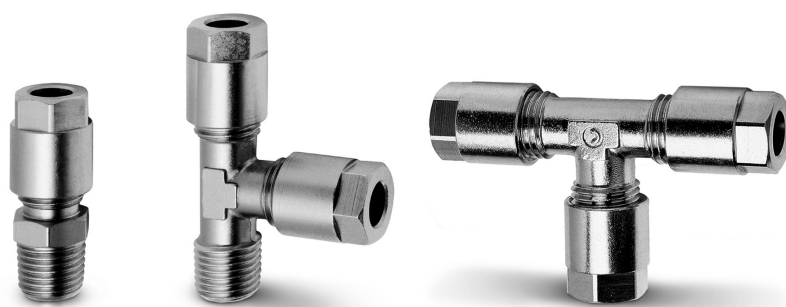

Los racores universales de ojiva Serie 1000 son utilizados con tubos de plástico de todo tipo y también con tubos de cobre, latón, acero y aluminio. Aptos para diversas aplicaciones, estos racores pueden ser empleados en circuitos neumáticos, oleodinámicos e hidráulicos a baja presión.

Los asientos de los racores, las ojivas y las tuercas están en conformidad con las normas DIN 3870-3861.

## CARACTERÍSTICAS GENERALES

<b>Diámetros</b>	4 - 6 - 8 - 10 - 12 mm
<b>Roscas</b>	GAS cónico ISO 7 (BSPT) GAS cilíndrico ISO 228 (BSP)
<b>Temperatura</b>	(ver características de los tubos utilizados)
<b>Tubo de conexión</b>	cobre recocido y tubos de plástico (con refuerzo)
<b>Fluido</b>	aire comprimido y fluidos a baja presión
<b>Materiales</b>	latón niquelado
<b>Presión</b>	presión máx 40 bar

## Racores con tubo de conexión

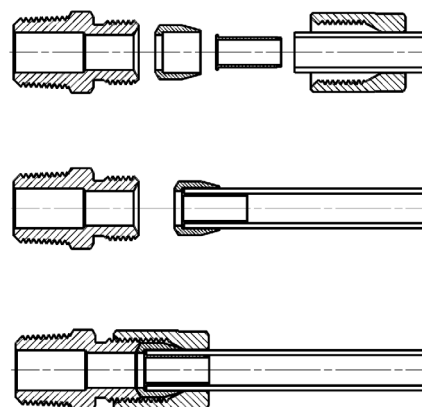

### Racores Mod. 1050



Recto Macho Cónico

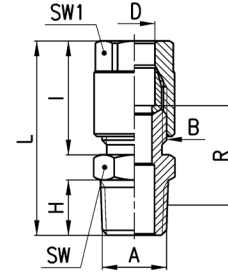

DIMENSIONES										
Mod.	D	A	B	H	I	L	R	SW	SW1	Peso (g)
1050 4-1/8	4	R1/8	1/8	7,5	19	31	14	12	12	19
1050 6-1/8	6	R1/8	1/8	7,5	19	31	14	12	12	18
1050 6-1/4	6	R1/4	1/8	11	19	35	16,5	14	12	23
1050 8-1/8	8	R1/8	1/4	7,5	23	35	15,5	14	14	29
1050 8-1/4	8	R1/4	1/4	11	23	39	18	14	14	33
1050 8-3/8	8	R3/8	1/4	11,5	23	39,5	18	17	14	40
1050 10-1/4	10	R1/4	3/8	11	25,5	41,5	18	17	17	51
1050 10-3/8	10	R3/8	3/8	11,5	25,5	42	18	17	17	55
1050 10-1/2	10	R1/2	3/8	14	25,5	45	18	22	17	65
1050 12-1/4	12	R1/4	M18x1,5	11	24,5	40,5	12	19	19	56 *
1050 12-3/8	12	R3/8	M18x1,5	11,5	24,5	41	12	19	19	58 *
1050 12-1/2	12	R1/2	M18x1,5	14	24,5	44	12	22	19	68 *

\* = con ojiva bicónica

### Racores Mod. 1063

Recto Hembra Cilíndrico

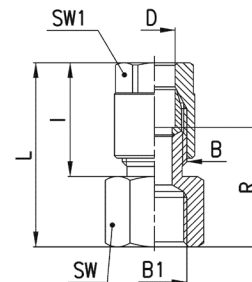

DIMENSIONES									
Mod.	D	B1	B	I	L	R	SW	SW1	Peso (g)
1063 4-1/8	4	G1/8	1/8	19	29	18,5	13	12	19
1063 6-1/8	6	G1/8	1/8	19	29	18,5	13	12	18
1063 6-1/4	6	G1/4	1/8	19	30,5	20	17	12	25
1063 8-1/8	8	G1/8	1/4	23	33	20	14	14	31
1063 8-1/4	8	G1/4	1/4	23	34,5	21,5	17	14	35

**Racores Mod. 1020**

Codo Macho Fijo Cónico

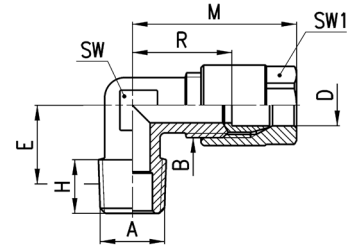

DIMENSIONES										
Mod.	D	A	B	E	H	M	R	SW	SW1	Peso (g)
1020 4-1/8	4	R1/8	1/8	11,5	7,5	29,5	19	9	12	21
1020 6-1/8	6	R1/8	1/8	11,5	7,5	29,5	19	9	12	19
1020 6-1/4	6	R1/4	1/8	13,5	11	29,5	19	12	12	27
1020 8-1/8	8	R1/8	1/4	11,5	7,5	33	20	11	14	35
1020 8-1/4	8	R1/4	1/4	13,5	11	33	20	12	14	36
1020 8-3/8	8	R3/8	1/4	15,5	11,5	35	22	14	14	50
1020 10-1/4	10	R1/4	3/8	15	11	38	22,5	13	17	59
1020 10-3/8	10	R3/8	3/8	15,5	11,5	38	22,5	14	17	58
1020 10-1/2	10	R1/2	3/8	16	14	38	22,5	16	17	78
1020 12-1/4	12	R1/4	M18x1,5	15	11	37	16,5	15	19	66 *
1020 12-3/8	12	R3/8	M18x1,5	15	11,5	37	16,5	15	19	66 *
1020 12-1/2	12	R1/2	M18x1,5	16	14	37	16,5	16	19	75 *

\* = con ojiva bicónica

**Racores Mod. 1093**

Codo Hembra Cilíndrico

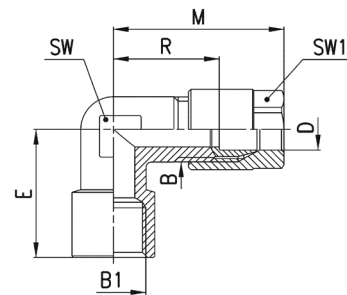

DIMENSIONES										
Mod.	D	B1	B	E	M	R	SW	SW1	Peso (g)	
1093 4-1/8	4	G1/8	1/8	19	29,5	18,5	12	12	31	
1093 6-1/8	6	G1/8	1/8	19	29,5	19	12	12	25	
1093 6-1/4	6	G1/4	1/8	23	30,5	20	13	12	39	
1093 8-1/8	8	G1/8	1/4	19	33	20	11	14	39	
1093 8-1/4	8	G1/4	1/4	23	35	22	13	14	44	

**Racores Mod. 1000**

Te Macho Fijo Cónico

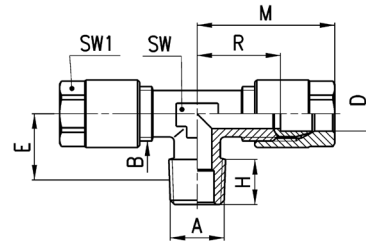

DIMENSIONES										
Mod.	D	A	B	E	H	M	R	SW	SW1	Peso (g)
1000 4-1/8	4	R1/8	1/8	11,5	7,5	29,5	19	9	12	35
1000 6-1/8	6	R1/8	1/8	11,5	7,5	29,5	19	9	12	33
1000 8-1/4	8	R1/4	1/4	13,5	11	33	20	12	14	63
1000 10-1/4	10	R1/4	3/8	15	11	38	22,5	13	17	104

**Racores Mod. 1010**

Te Macho Lateral Fijo Cónico

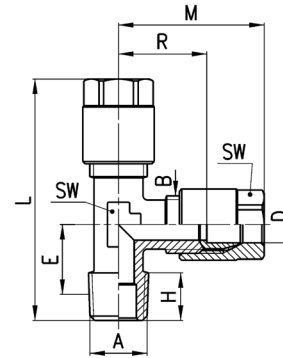

DIMENSIONES											
Mod.	D	A	B	E	H	L	M	R	SW	SW1	Peso (g)
1010 4-1/8	4	R1/8	1/8	11,5	7,5	48	29,5	19	9	12	37
1010 6-1/8	6	R1/8	1/8	11,5	7,5	48	29,5	19	9	12	33
1010 8-1/4	8	R1/4	1/4	13,5	11	54,5	33	20	12	14	61
1010 10-1/4	10	R1/4	3/8	15	11	61,5	38	22,5	13	17	103

**Racores Mod. 1230**

Recto Intermedio

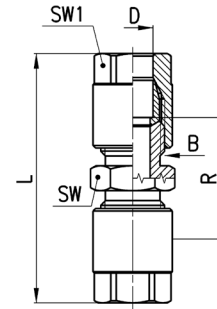

DIMENSIONES							
Mod.	D	B	L	R	SW	SW1	Peso (g)
1230 4	4	1/8	42,5	21,5	12	12	29
1230 6	6	1/8	42,5	21,5	12	12	26
1230 8	8	1/4	51	25	14	14	48
1230 10	10	3/8	56	25	17	17	83
1230 12	12	M18x1,5	54	13	19	19	140

\* = con ojiva bicónica

**Racores Mod. 1250**

Recto Pasamuros

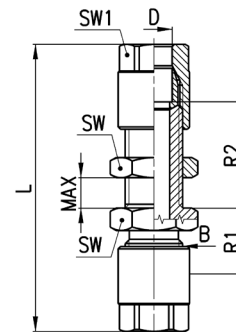

DIMENSIONES									
Mod.	D	B	L	R1	R2	MAX	SW	SW1	Peso (g)
1250 4	4	1/8	57,5	12,5	23	12	14	12	40
1250 6	6	1/8	57,5	13	23,5	12	14	12	38
1250 8	8	1/4	65	15	24	13	17	14	67
1250 10	10	3/8	72,5	15	26,5	13	22	17	119

### Racores Mod. 1220

Codo Intermedio

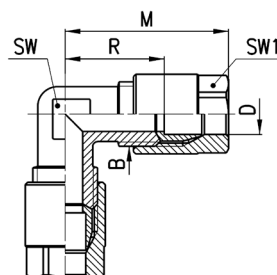

DIMENSIONES							
Mod.	D	B	M	R	SW	SW1	Peso (g)
1220 4	4	1/8	29,5	19	9	12	31
1220 6	6	1/8	29,5	19	9	12	29
1220 8	8	1/4	33	20	11	14	53
1220 10	10	3/8	38	22,5	14	17	92
1220 12	12	M18x1,5	37	16,5	16	19	99 *

\* = con ojiva bicónica

### Racores Mod. 1210

Te Intermedio

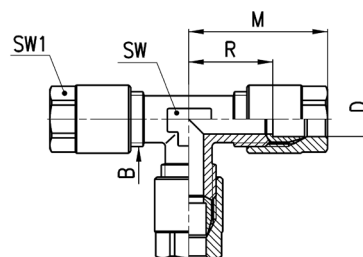

DIMENSIONES							
Mod.	D	B	M	R	SW	SW1	Peso (g)
1210 4	4	1/8	29,5	19	9	12	45
1210 6	6	1/8	29,5	19	9	12	42
1210 8	8	1/4	33	20	12	14	79
1210 10	10	3/8	38	22,5	13	17	133
1210 12	12	M18x1,5	37	16,5	16	19	144 *

\* = con ojiva bicónica

### Racores Mod. 1170

Anillo Individual

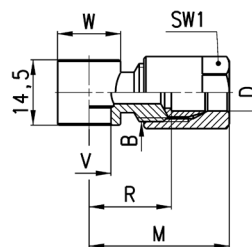

DIMENSIONES									
Mod.	D	B	R	M	V	W	SW1	Peso (g)	ensamblables con Mod.
1170 6-1/8	6	1/8	17.5	28	9.8	14	12	20	1631, 1635, SCU, SVU, SCO...
1170 6-1/4	6	1/8	20	30.5	13.2	18	12	24	1631, 1635, SCU, SVU, SCO...
1170 8-1/8	8	1/4	18	31	9.8	14	14	31	1635, SCU, SVU, SCO...

### Accesorios Mod. 1303

Tuerca de bloqueo

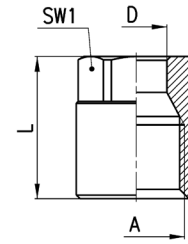

DIMENSIONES					
Mod.	D	A	L	SW1	Peso (g)
1303 4-1/8	4	1/8	15,5	12	8
1303 6-1/8	6	1/8	15,5	12	8
1303 8-1/4	8	1/4	19	14	14
1303 10-3/8	10	3/8	21,5	17	24
1303 12-M18x1,5	12	M18x1,5	19,5	19	27

### Accesorios Mod. 1310

Ojiva y Bicóno

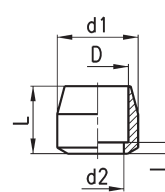

FIG. 1

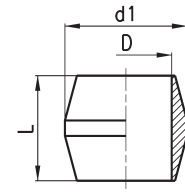

FIG. 2

DIMENSIONES						
Mod.	D	d1	d2	l	L	Peso (g)
1310 4	4	7,8	3	1	8	2
1310 6	6	7,8	4,5	1	7	1
1310 8	8	10,8	7	1,5	9	3
1310 10	10	13,8	9	1,5	11,5	5
1310 12-M18	12	16,3	12	-	11	6 *

Fig. 1 = ojiva

Fig. 2 = ojiva biconica

\* = con ojiva biconica

### Accesorios Mod. 1320

Insertos

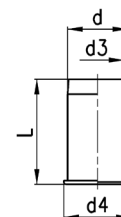

DIMENSIONES					
Mod.	d	d3	d4	L	Peso (g)
1320 4	4	3	5	12	1
1320 6	6	5	7	13	1
1320 8	8	7	9	14	1
1320 10	10	9	11	16	2