

Series 5V vertical electromechanical axis

Sizes 50, 65, 80



- » High dynamics
- » Easy to integrate in x-y-z systems
- » Strokes up to 1500 mm
- » Version with integrated shock absorbers
- » Greasing nipples included
- » Supplied with slider's centering bushings

The 5V vertical electromechanical axis represents the ideal solution for applications that require vertical displacements as for example pick and place, dispensing, loading/unloading systems (plastic injection moulding, assembly, machining) or palletisers. Available in three sizes, 50, 65 and 80, it can be used as vertical axis of a x,y,z gantry system or cantilever in applications that require to move loads for long strokes quickly and thus optimise the machine cycle time.

The new Series 5V axes are mechanical linear actuators with toothed belt. Thanks to a specific pulley system with omega configuration, these axes allow to reduce to a minimum the inertia of the system. Furthermore, the presence of one or more recirculating ball guides (HS version) as well as of a special self-supporting square profile provides high stiffness and resistance to dynamic loads, ensuring a precise and fast displacement of heavy loads.

GENERAL DATA

Construction	electromechanical axis with toothed belt
Design	open profile with protection plate
Operation	linear multi-position actuator
Sizes	50, 65, 80
Strokes	max 1500 mm
Type of guide	internal, with recirculating balls (cage type)
Fixing	by means of dedicated accessories
Mounting motor	on both sides
Operating temperature	-10°C ÷ +50°C
Storage temperature	-20°C ÷ +80°C
Protection class	IP 20
Lubrication	centralized lubrication by means of internal channels
Repeatability	± 0.05 mm
Duty cycle	100%
Use with external sensors	C5H and CST magnetic switches by means of accessories Mod. SMS

CODING EXAMPLE

5V	S	050	TBL	0200	A	S	1
-----------	----------	------------	------------	-------------	----------	----------	----------

5V	SERIES
S	PROFILE: S = square section
050	FRAME SIZE: 050 = 50x50 mm 065 = 65x65 mm 080 = 80x80 mm
TBL	TRANSMISSION: TBL = toothed belt
0200	STROKE [C]: 0050 ÷ 1500 mm
A	VERSION: A = standard H = reinforced axis (for sizes 65 and 80 only)
S	TYPE OF SLIDER: S = standard
1	NUMBER OF SLIDERS: 1 = 1 slider
	TYPE OF END CAP: = standard SA = shock absorber integrated

SERIES 5V ELECTROMECHANICAL AXIS

MECHANICAL CHARACTERISTICS

(A) Value refers to a covered distance of 2000 Km with fully supported system.

	Measuring unit	Size 50	Size 65	Size 65	Size 80	Size 80
Version		A	A	H	A	H
Type of slider		S	S	S	S	S
Number of guides	pcs	1	1	2	1	2
Number of RDS blocks	N	2	2	4	2	4
Fy, eq (A)	N	3400	8300	16600	13100	26000
Fz, eq (A)	Nm	3400	8300	16600	13100	26000
Mx, eq (A)	Nm	19.4	47.7	234.7	106	454
My, eq (A)	m/s	91.7	282.3	564.7	626	1252
Mz, eq (A)	m/s ²	91.7	282.3	564.7	626	1252
Max linear speed of mechanics (Vmax)		3	3	3	3	3
Max linear acceleration of mechanics (amax)		30	30	30	30	30
PROFILE						
RECIRCULATING BALL GUIDE (CAGE TYPE)						
Moment of surface inertia Iy	mm ⁴	1.89 · 10 ⁵	4.94 · 10 ⁵	4.94 · 10 ⁵	1.23 · 10 ⁶	1.23 · 10 ⁶
Moment of surface inertia Iz	mm ⁴	2.48 · 10 ⁵	6.97 · 10 ⁵	6.97 · 10 ⁵	1.68 · 10 ⁶	1.68 · 10 ⁶
TOOTHED BELT						
Type		25 AT 5 HP	40 AT 5 HP	40 AT 5 HP	45 AT 10 HP	45 AT 10 HP
Pitch	mm	5	5	5	10	10
Safe loads	N	See the diagram	See the diagram	See the diagram	See the diagram	See the diagram
PULLEY						
Effective diameter of the pulley	mm	47.75	57.30	57.30	76.39	76.39
Number of teeth	z	30	36	36	24	24
Linear movement per pulley round	mm/round	150	180	180	240	240

SERIES 5V MATERIALS

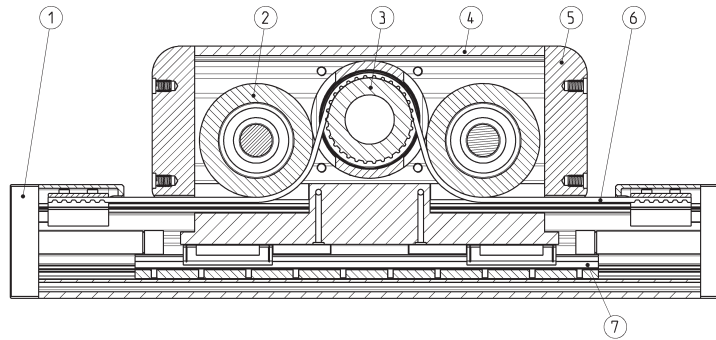

COMPONENTS	MATERIALS
1. End cap	Aluminium alloy
2. Idler	Aluminium alloy
3. Pulley	Steel
4. Omega body	Aluminium alloy
5. Cover	Aluminium alloy
7. Belt	PU + Steel
8. Recirculating ball guide	Steel

WEIGHT DISTINCTION

1 = fixed mass M_f
 2 = moving mass
 3 = moving mass that varies according to the stroke K_{tv}

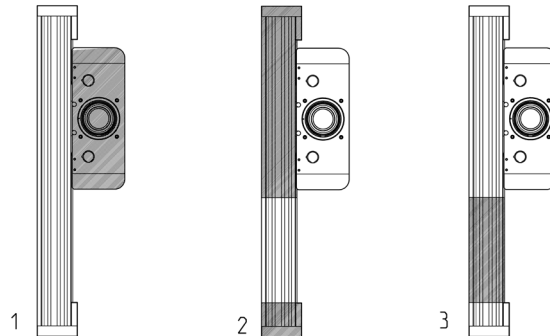

5V...AS1					
Size	M_f [Kg]	m_{c1} [Kg]	K_{tv} [Kg/m]	tot weight stroke 0 [Kg]	J_{tot} [Kg*mm ²]
50	3.37	1.49	3.15	4.86	183.83
65	6.14	2.67	5.13	8.81	480.26
80	12.16	6.43	8.3	18.59	1489.03

5V...HS1					
Size	M_f [Kg]	m_{c1} [Kg]	K_{tv} [Kg/m]	tot weight stroke 0 [Kg]	J_{tot} [Kg*mm ²]
65	6.28	4	6.35	10.28	480.26
80	13.05	10.27	10.11	23.32	1489.03

HOW TO CALCULATE THE LIFE OF THE 5V AXIS

With the correct dimensioning of the 5V axis, used individually or in a cartesian system with several axes, you need to consider different factors, both static and dynamic. The most important of these are described on the following pages.

CALCULATION OF LIFE [km]

Leq = life of the 5v axis [km]

fl = load coefficient

fw = safety coefficient

According to the operating conditions, the loads acting on the actuator (Fy, Fz, Mx, My and Mz) that appear in the fl calculation are the average ones on the cycle.

These are calculated by averaging the loads of each single phase as indicated in the equation of P.

ls = stroke s1 = acc. phase;

s2= constant speed phase; s3 = deceleration phase

P = Mx / My / Mz / Fy / Fz

$$f_l = \frac{|F_y|}{F_{y,eq}} + \frac{|F_z|}{F_{z,eq}} + \frac{|M_x|}{M_{x,eq}} + \frac{|M_y|}{M_{y,eq}} + \frac{|M_z|}{M_{z,eq}}$$

$$L_{eq} = \left(\frac{1}{f_l \cdot f_w} \right)^3 \cdot 2000$$

$$P = \sqrt[3]{\frac{1}{l_s} \cdot \sum_{i=1}^n (P_i^3 \cdot s_i)}$$

$$P = \sqrt[3]{\frac{1}{l_s} \cdot (P_1^3 \cdot s_1 + P_2^3 \cdot s_2 + P_3^3 \cdot s_3)}$$

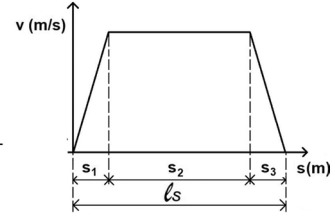

EQUIVALENT LOAD

Fy = Force acting along the Y-axis [N]

Fz = Force acting along the Z-axis [N]

K = fixed distance for 5V axis [mm]

Mx = Moment along X-axis [Nm]

My = Moment along Y-axis [Nm]

Mz = Moment along Z-axis Z [Nm]

Here you can find the "K" values, valid for the sizes:

- K = 21 mm (5VS050)

- K = 28 mm (5VS065)

- K = 36 mm (5VS080)

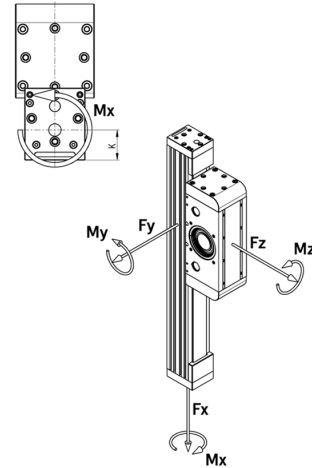

GRAPH OF THE SERVICE LIFE

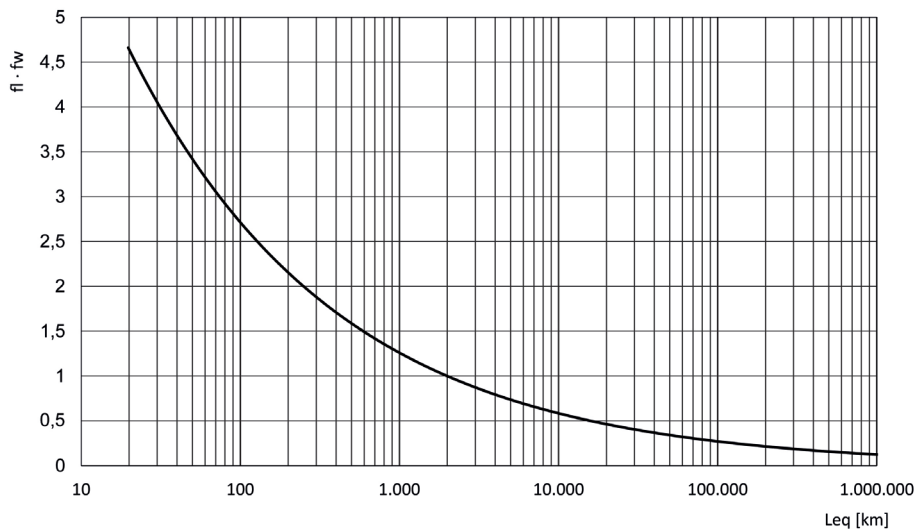

HOW TO CALCULATE THE SERVICE LIFE - 5VS065TBL0750AS1

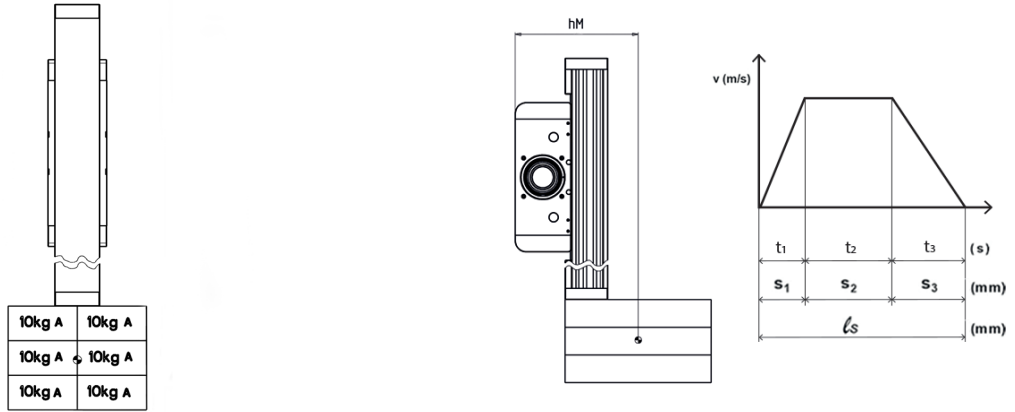

Application data:
 M = 60
 hM = 233 mm

acc = dec = 10 m/s² v = 0.8 m/s
 s1 = s3 = 32 mm
 lS = 750 mm
 fw = 1,5

HOW TO CALCULATE THE APPLIED LOADS

$$F_y = 0 \text{ N}$$

$$F_z = 0 \text{ N}$$

$$M_{x_{1,2,3}} = 0 \text{ Nm}$$

$$M_{y_1} = F_x \cdot (h_M - k) = M \cdot (g + a) \cdot (h_M - k) = 60 \cdot (9.81 + 10) \cdot (0.233 - 0.028) = 243.7 \text{ Nm}$$

$$M_{y_2} = F_x \cdot (h_M - k) = M \cdot (g + a) \cdot (h_M - k) = 60 \cdot (9.81 + 0) \cdot (0.233 - 0.028) = 120.7 \text{ Nm}$$

$$M_{y_3} = F_x \cdot (h_M - k) = M \cdot (g + a) \cdot (h_M - k) = 60 \cdot (9.81 - 10) \cdot (0.233 - 0.028) = 2.34 \text{ Nm}^*$$

$$M_{z_{1,2,3}} = 0$$

$$M_y = \sqrt[3]{\frac{1}{750} \cdot (243.7^3 \cdot 32 + 120.7^3 \cdot 686 + 2.34^3 \cdot 32)} = 148.4 \text{ Nm}$$

$$fl = \frac{|F_y|}{F_{y,eq}} + \frac{|F_z|}{F_{z,eq}} + \frac{|M_x|}{M_{x,eq}} + \frac{|M_y|}{M_{y,eq}} + \frac{|M_z|}{M_{z,eq}} = \frac{0}{8300} + \frac{0}{8300} + \frac{148.4}{324} + \frac{0}{324} + \frac{0}{55} = 0.458$$

HOW TO CALCULATE THE SERVICE LIFE

Once the fl value has been calculated, the service life value can be obtained from the graph or by using the formula:

$$Leq \left(\frac{1}{fl \cdot fw} \right)^3 \times 2000 = \left(\frac{1}{0.458 \cdot 1.5} \right)^3 \times 2000 = 6167 \text{ km}$$

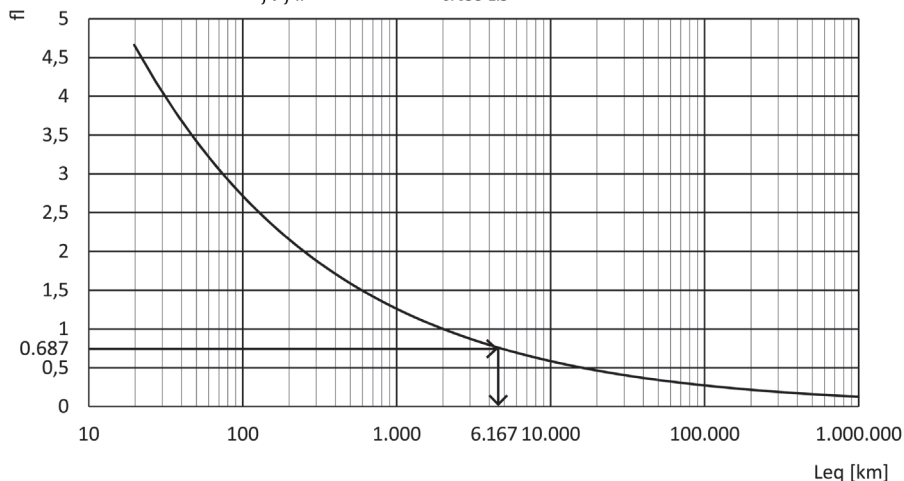

HOW TO CALCULATE THE DRIVING TORQUE [Nm]

FA = Total force acting from outside [N]
 FE = Force to be applied externally [N]
 g = Gravitational acceleration (9.81 m/s²)
 mE = Mass of the body to move [kg]
 DP = Pulley pitch diameter [mm]
 CM1 = Driving torque due to external agents [Nm]

$$C_{TOT} = C_{M1} + C_{M2} + C_{M3}$$

$$F_A = F_E + m_E \cdot (a \pm g)$$

$$C_{M1} = \frac{F_A \cdot D_P}{2}$$

$$\dot{\omega} = \frac{2 \cdot a}{D_P}$$

$$C_{M2} = J_{TOT} \cdot \dot{\omega}$$

JTOT = Moment of inertia of rotating components [kg·m²]
 $\dot{\omega}$ = Angular acceleration [rad/s²]
 a = Axis linear acceleration [m/s²]
 CM2 = Driving torque due to rotating components [Nm]

$$F_{TT} = F_{TF} + F_{TV}$$

FTT = Force needed to moves sliding components [N]
 FTF = Force needed to move fixed-length sliding components [N]
 FTV = Force needed to move variable-length sliding components [N]
 mC1 = Mass of fixed-length sliding components [kg]
 KTV = Mass coefficient of variable-length sliding components [kg/mm]
 CM3 = Driving torque due to sliding components [Nm]
 C = Stroke [mm]

$$F_{TF} = m_{C1} \cdot (a \pm g)$$

$$F_{TV} = K_{TV} \cdot C \cdot (a \pm g)$$

$$C_{M3} = \frac{F_{TT} \cdot D_P}{2}$$

According to the axis size and to the speeds chosen, force that can be transmitted from the toothed belt has these limits.

TRANSMISSIBLE FORCE

The force that can be transmitted from the toothed belt depends on the axis size and speeds chosen.

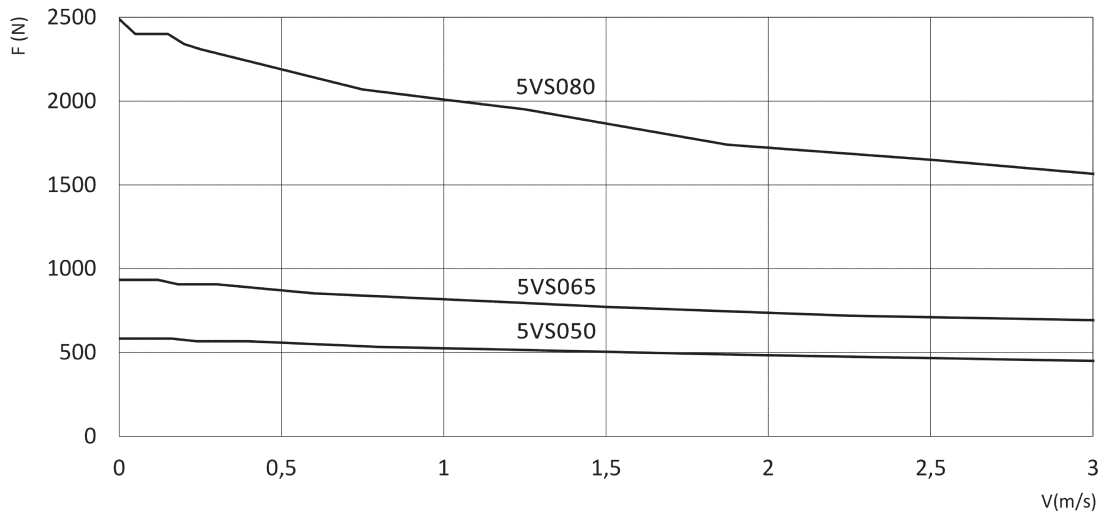

DEFLECTION 5VS050 - Version A

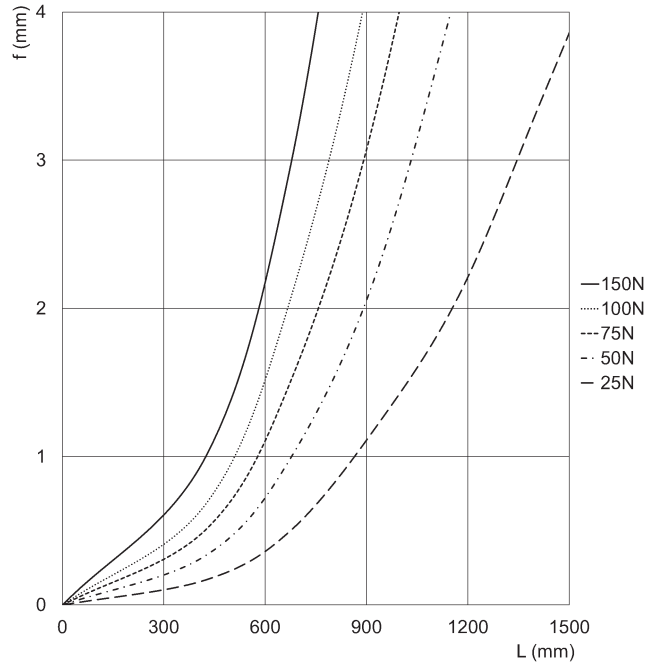
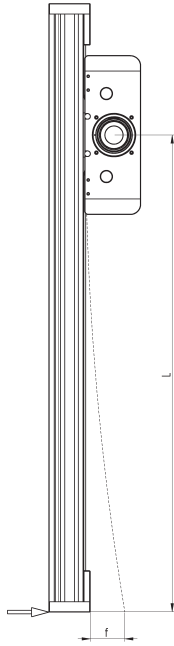

f = generated deflection [mm]
 L = arm length [mm]

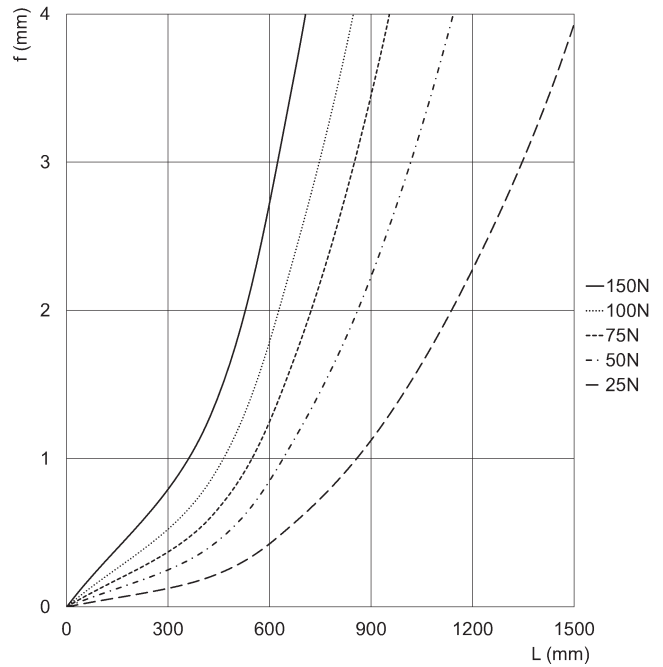
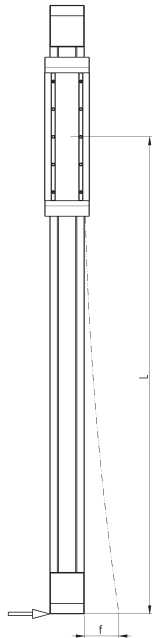

f = generated deflection [mm]
 L = arm length [mm]

DEFLECTION 5VS065 - Version A

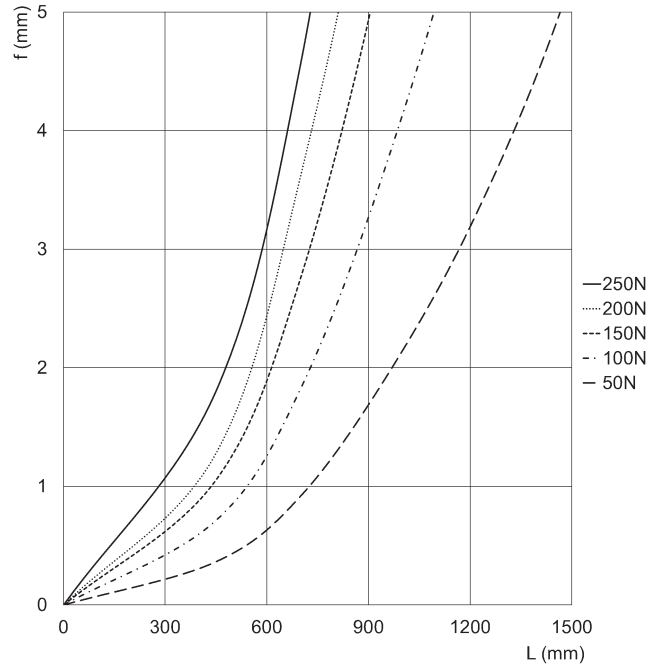
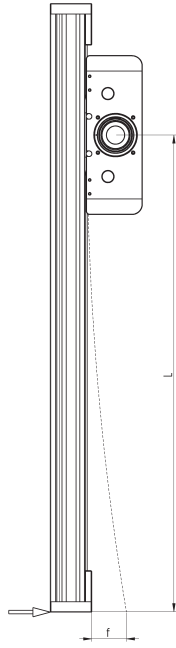

f = generated deflection [mm]
 L = arm length [mm]

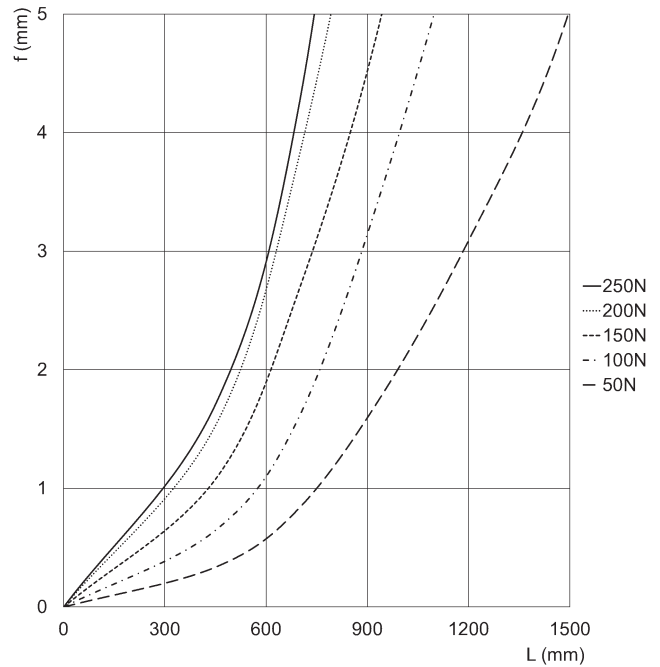
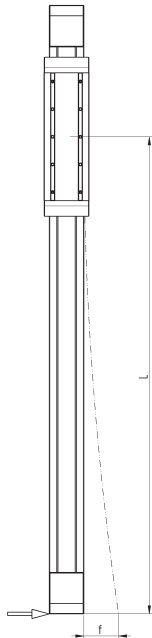

f = generated deflection [mm]
 L = arm length [mm]

DEFLECTION 5VS065 - Version H

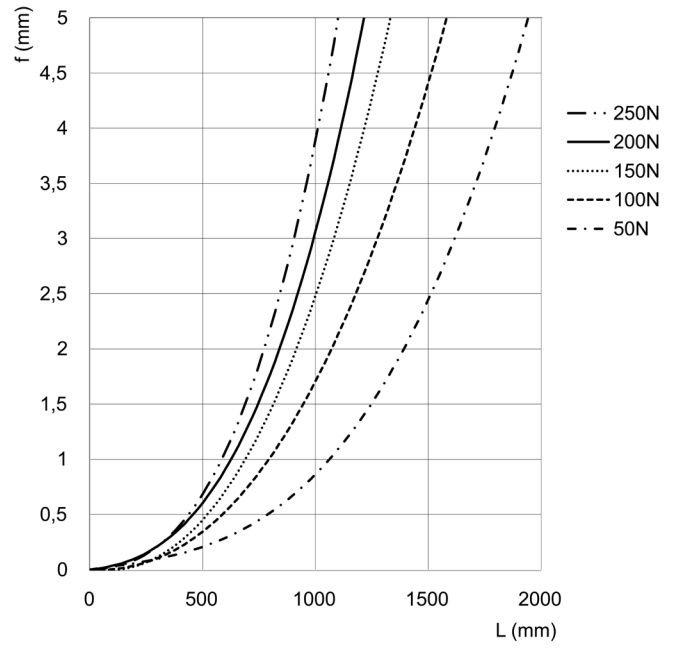
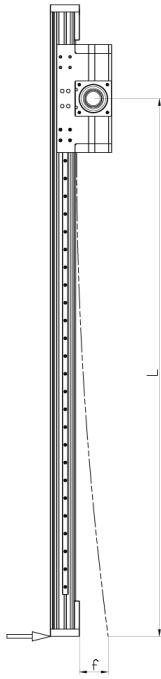

f = generated deflection [mm]
L = arm length [mm]

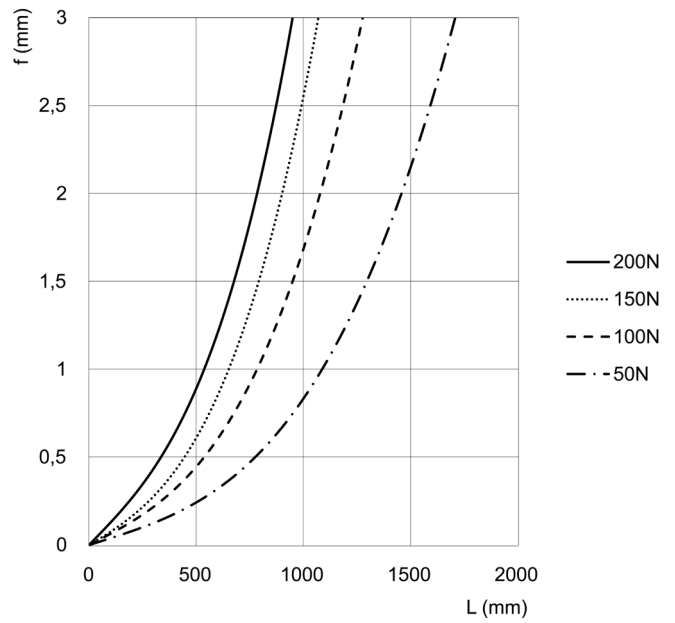
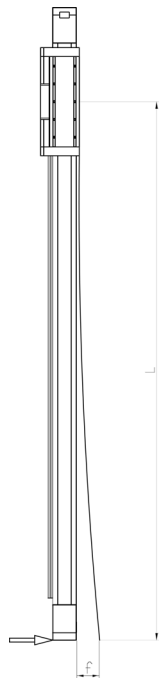

f = generated deflection [mm]
L = arm length [mm]

DEFLECTION 5VS080 - Version A

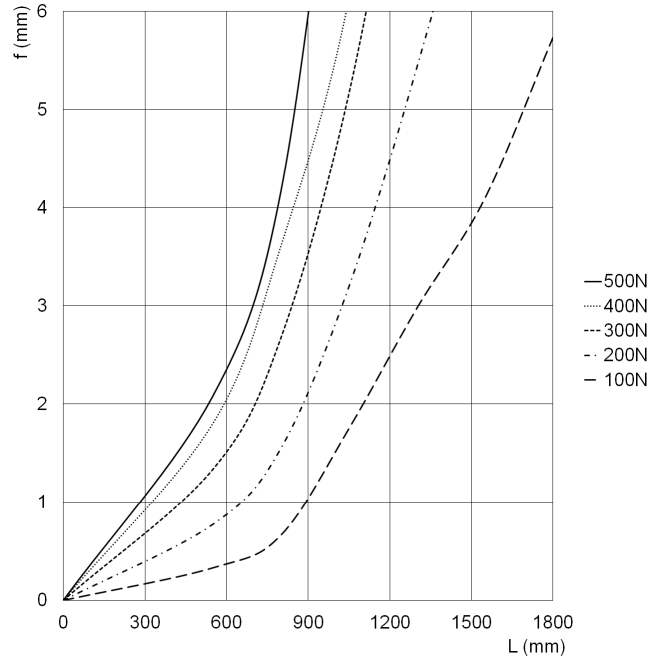
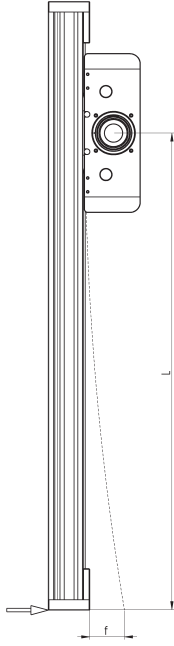

f = generated deflection [mm]
 L = arm length [mm]

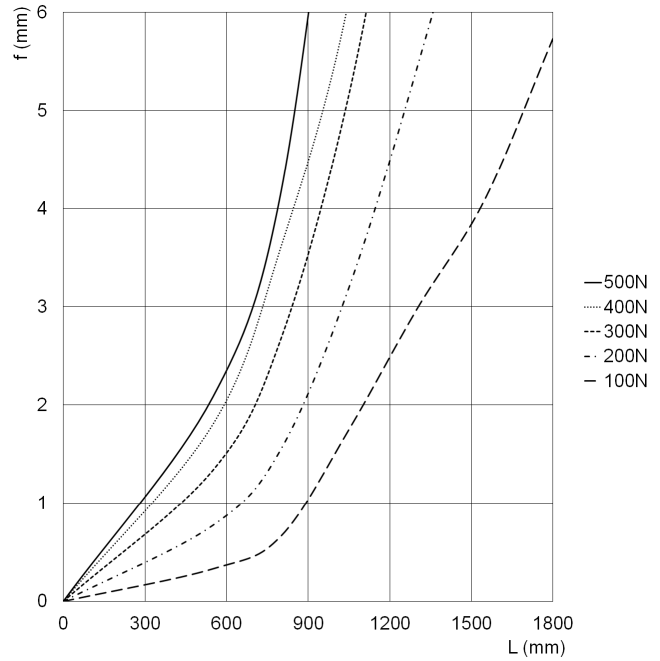
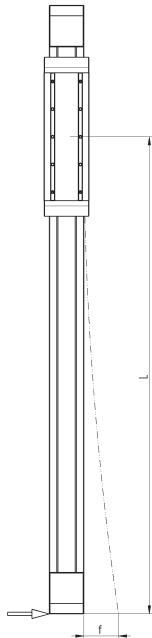

f = generated deflection [mm]
 L = arm length [mm]

DEFLECTION 5VS080 - Version H

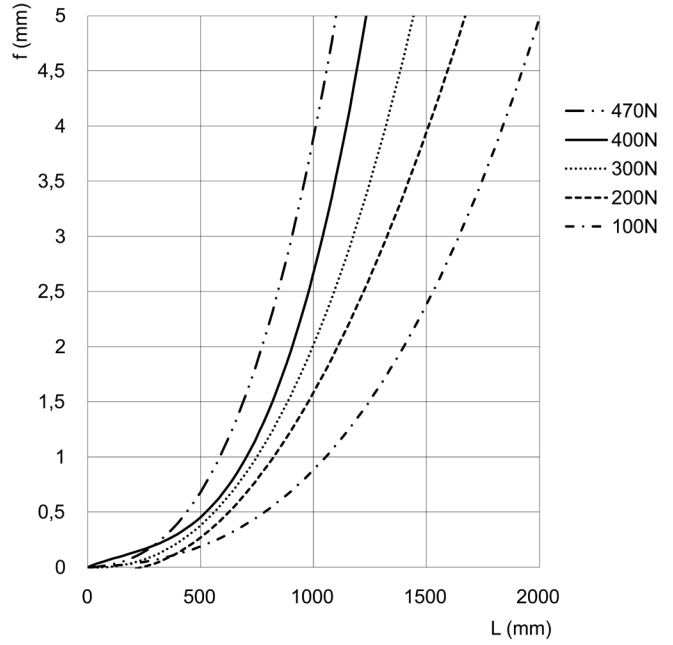
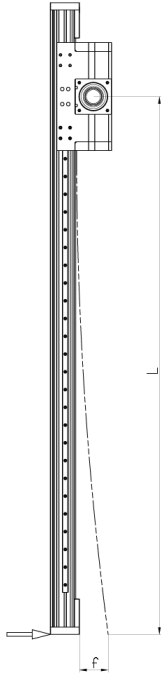

f = generated deflection [mm]
L = arm length [mm]

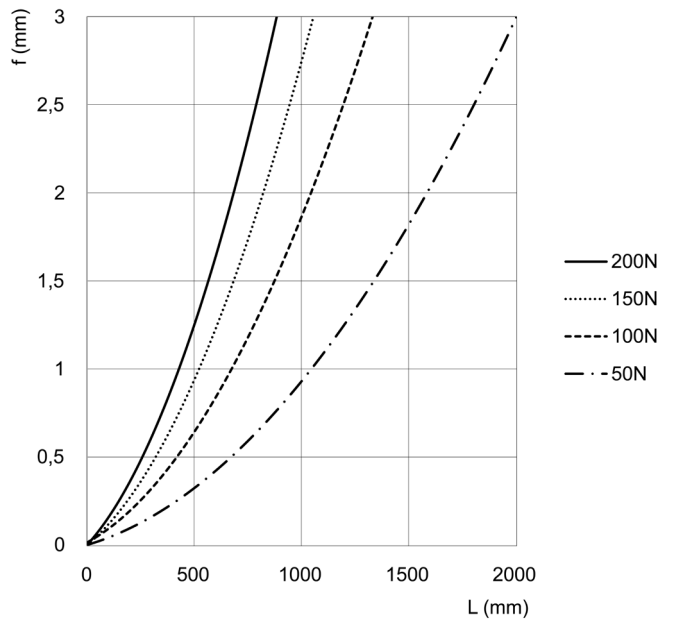
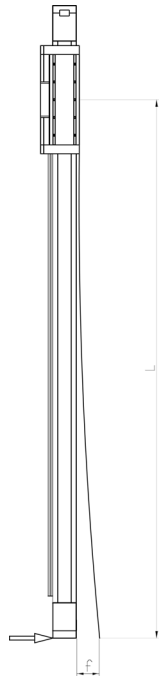

f = generated deflection [mm]
L = arm length [mm]

ACCESSORIES FOR SERIES 5V

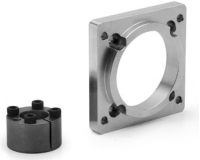

Kit to connect the gearbox

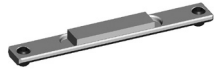

Magnet kit
Mod. SMS-5V-U

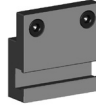

Sensor holder kit
Mod. SMS-5V



Centering ring
Mod. TR-CG



5E/5V connection flange



Nuts for slots

SERIES 5V ELECTROMECHANICAL AXIS



All accessories are supplied separately from the axis.

Electromechanical axis Mod. 5V...AS1

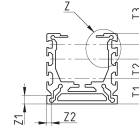
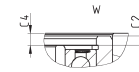
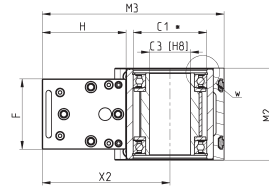
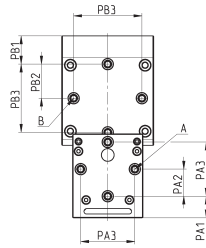

+ = add the stroke

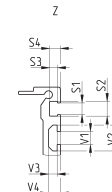
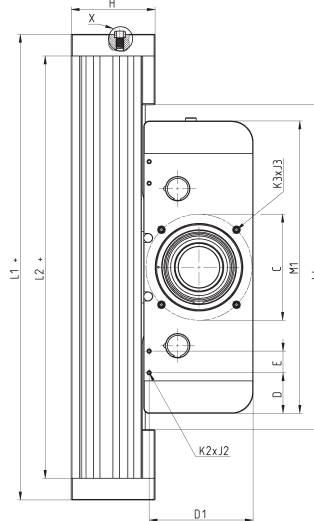
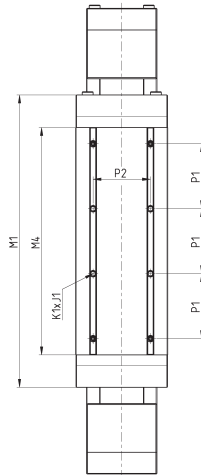

Size	WEIGHT STROKE ZERO (kg)	STROKE WEIGHT PER METER (kg/m)
50	4.86	3.15
65	8.81	5.13
80	18.59	8.3

Size	A	B	$\varnothing C$	$\varnothing C1$	C2	$\varnothing C3$ [H8]	C4	D	E	F	H	K	L1	L2	M1	M2	M3	M4
50	M5x7,5	M5x7,5	72	4.9	4.9	26	4.5	30	20	50	60	1.5	380	350	230	86	133	185
65	M6x9	M6x9	98	4.4	4.4	38	4.5	37.5	20	65	77.5	19	430	390	270	106	168	210
80	M8x12	M8x12	133	7.8	7.8	47	5	37.5	20	80	97.5	22	635	585	365	130.5	205	305

Size	P1	P2	PA1	PA2	PA3	PB1	PB2	PB3	X2	W+	K1xJ1	K2xJ2	K3xJ3	$\varnothing G1$ (H8)	G2	G3
50	40	40	14.5	20	40	21	25	50	94.3	260	M4x4,7	M3x6	M5x7.5	8	3	9.5
65	60	53	20	25	50	26	31.5	63	118	300	M5x4,7	M3x6	M6x10	10	3	12
80	60	70	24	32.5	65	37	35	70	144	395	M6x5	M3x6	M8x18	12	3	12

Size	Z1	Z2	T1	T2	T3	S1	S2	S3	S4	V1	V2	V3	V4
50	8	4	20	-	10	5.4	6.8	3.65	5	6	12	4	5.5
65	8	4	23.5	18	10	5.4	6.8	3.65	5	6	12	4	5.5
80	8	4	25	25	10	5.4	6.8	3.65	5	8	16.5	6.8	9

Electromechanical axis Mod. 5V...HS1



SERIES 5V ELECTROMECHANICAL AXIS

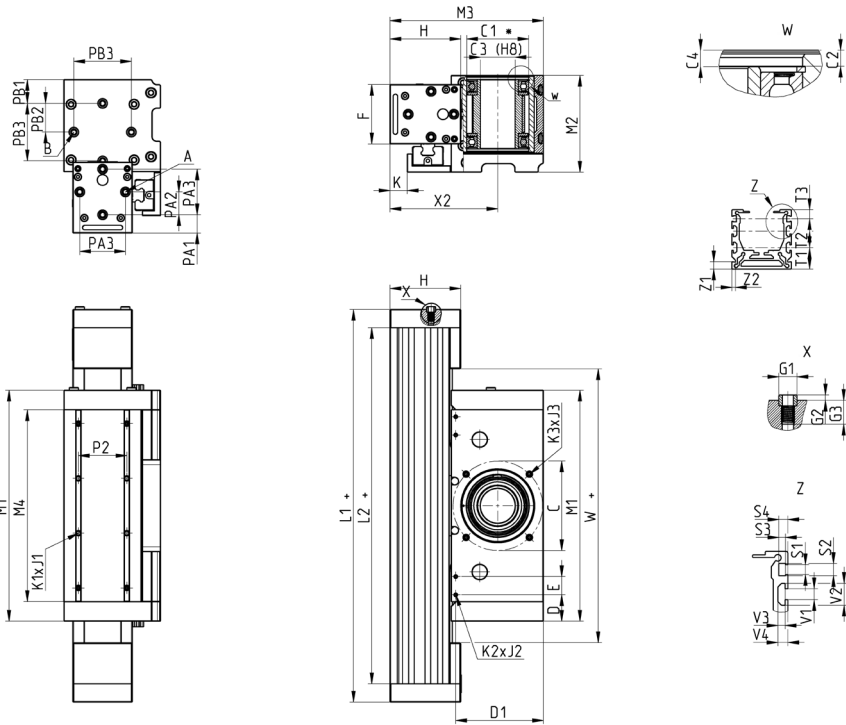

+ = add the stroke

Size	WEIGHT STROKE ZERO (kg)	STROKE WEIGHT PER METER (kg/m)
65	8.81	5.13
80	18.59	8.3

Size	A	B	°C	°C1	C2	°C3 [H8]	C4	D	E	F	H	K	L1	L2	M1	M2	M3	M4
65	M6x9	M6x9	98	4.4	4.4	38	4.5	37.5	20	65	77.5	19	430	390	270	106	168	210
80	M8x12	M8x12	133	7.8	7.8	47	5	37.5	20	80	97.5	22	635	585	365	130.5	205	305

Size	P1	P2	PA1	PA2	PA3	PB1	PB2	PB3	X2	W+	K1xJ1	K2xJ2	K3xJ3	°G1 (H8)	G2	G3
65	60	53	20	25	50	26	31.5	63	118	300	M5x4,7	M3x6	M6x10	10	3	12
80	60	70	24	32.5	65	37	35	70	144	395	M6x5	M3x6	M8x18	12	3	12

Size	Z1	Z2	T1	T2	T3	S1	S2	S3	S4	V1	V2	V3	V4
65	8	4	23.5	18	10	5.4	6.8	3.65	5	6	12	4	5.5
80	8	4	25	25	10	5.4	6.8	3.65	5	8	16.5	6.8	9

Kit to connect the gearbox

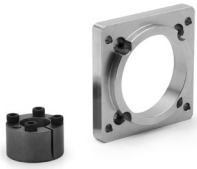

The kit includes:
 1x connection flange
 4x screws + 4x lock washers
 to connect the flange
 1x locking set
 4x screws + 4x lock washers
 to connect the gearbox

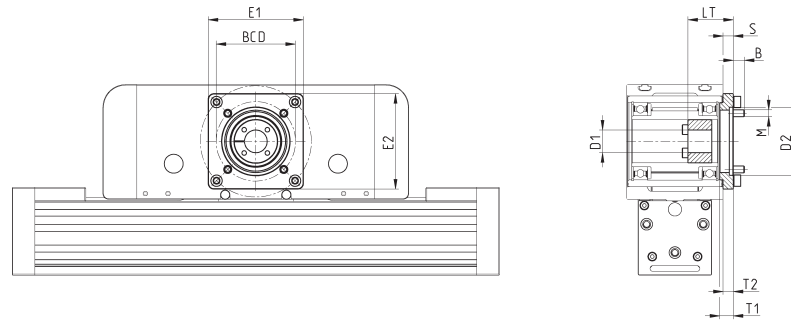

Mod.	Size	Gearbox	E1	E2	S	LT	\varnothing BCD	\varnothing D1	\varnothing D2 ^(H7)	T1	T2	M	B	Max torque (Nm) ^(A)	J (Kgmm ²)	Weight (g)
FR-5V-50	50	GB-060	65	65	6	35	52	14	40	10	-	5	7.9	30	5.49	130
FR-5V-65	65	GB-080	84	84	9	40	70	20	60	12	3.5	6	9.8	125	31.20	300
FR-5V-80	80	GB-120	115	115	13	55	100	25	80	18	4.5	10	15.8	215	90.06	620

(A) value refers to ideal mounting and operating conditions.
 For further details, please contact service@camozzi.com

Magnet kit Mod. SMS-5V-U



Supplied with:
 1x plate
 1x magnet
 2x locking screws

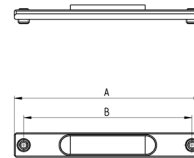

Mod.	A	B
SMS-5V-U	50	45

Sensor holder kit Mod. SMS-5V

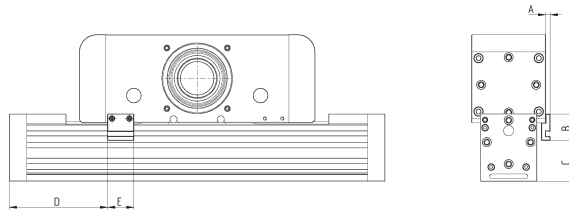
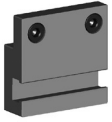

Supplied with:
1x plate
2x screws

Mod.	Size	A	B	C	D	E
SMS-5V-50	50	7.5	30	32	100	30
SMS-5V-65/80	65	5	30	47	112.5	30
SMS-5V-65/80	80	5	30	63	167.5	30

Centering ring Mod. TR-CG

Supplied with:
2x centering rings in steel

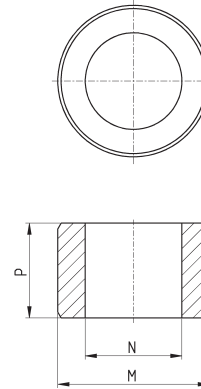

Mod.	M (h8)	N	P
TR-CG-04	Ø4	Ø2.6	2.5
TR-CG-05	Ø5	Ø3.1	3
TR-CG-06	Ø6	Ø4.1	4
TR-CG-08	Ø8	Ø5.1	5
TR-CG-10	Ø10	Ø6.1	6
TR-CG-12	Ø12	Ø8.1	6

5E/5V connection flange

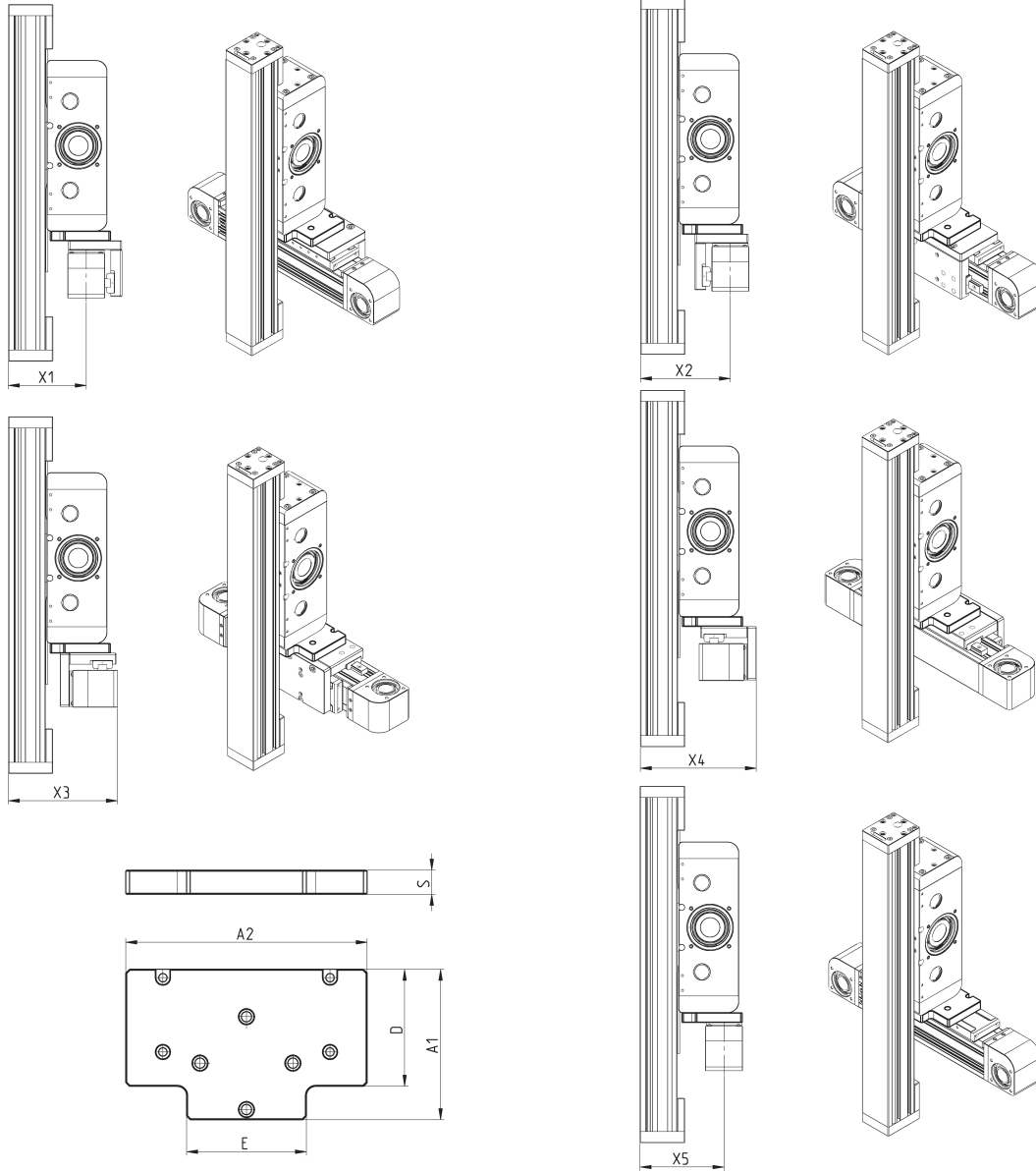

Mod.	Size	X1	X2	X3	X4	X5	A1	A2	E	D	S	Weight (g)
YZ-50-5V50	50	105	121	147	156	-	81	130	64.5	63	13	335
YZ-65-5V50	65	112.5	136.5	162	179	124.5	99.5	140	64.5	76.5	13	445
YZ-65-5V65	65	130	154	179.5	196.5	-	101.5	140	84.5	76.5	13	460
YZ-80-5V50	80	120.5	146.5	185.5	196.5	133.5	118	190	64.5	78	13	635
YZ-80-5V65	80	157.5	163.5	202.5	213.5	150.5	118	190	84.5	78	15	770
YZ-80-5V80	80	141	183.5	222.5	233.5	-	120	190	99.5	78	15	825

Slot nut for sensor

Material: steel



Supplied with:
2x nuts

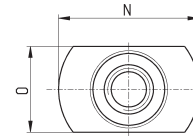
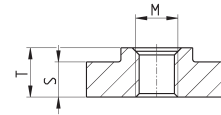

Mod.	Size	M	N	O	S	T
PCV-5E-CS-M3	50 - 65 - 80	M3	10.3	6.1	2.5	3.5
PCV-5E-CS-M4	50 - 65 - 80	M4	10.3	6.1	2.5	3.5

Slot nut 6 - rectangular type

Material: steel



Supplied with:
2x nuts

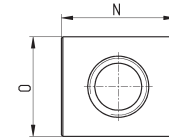
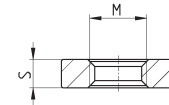

Mod.	Size	M	N	O	S
PCV-5E-C6-M4Q	50 - 65	M4	8	7	2

Slot nut 6 for front insertion

Material: steel



Supplied with:
2x nuts

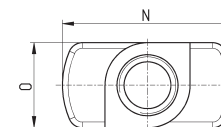
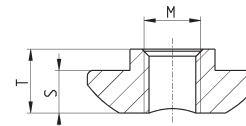

Mod.	Size	M	N	O	S	T
PCV-5E-C6-M4R	50 - 65	M4	12	6	3	4.5

Slot nut 8 with flexible flap

Material: steel



Supplied with:
2x nuts

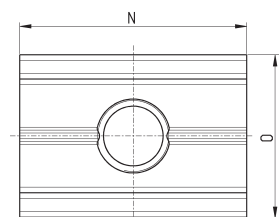
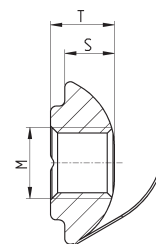

Mod.	Size	M	N	O	S	T
PCV-5E-C8-M5	80	M5	16	11.5	3.5	4.5
PCV-5E-C8-M6	80	M6	16	11.5	3.5	4.5