

Nuevo

RACORES SUPER RÁPIDOS GRIPFIT

SERIE 7000 - AUTOMATIZACIÓN

Diámetros exteriores del tubo: 4, 6, 8 mm
 Roscas: métrica paralela ISO-965 (M5, M7, M10x1, M12x1,25),
 ISO-7 BSPT (R1/8, R1/4, R3/8, R1/2),
 ISO-228 BSPP (G1/8, G1/4, G3/8, G1/2).

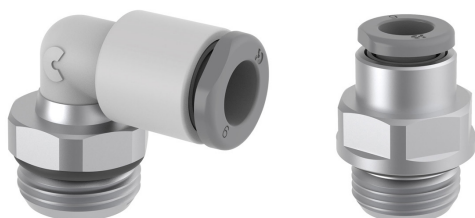

- Sellado óptimo
- Caudal máximo
- Compactas y ligeras

Los racores súper rápidos de automatización de la serie 7000 están fabricados en tecnopolímero reforzado para satisfacer las nuevas demandas del mercado en cuanto a fiabilidad, facilidad de uso y soluciones eficientes.

Sus dimensiones compactas y su ligereza hacen que esta nueva gama de racores sea ideal para la mayoría de las aplicaciones neumáticas asociadas a tecnologías de sujeción y sellado óptimas.

DATOS GENERALES

Diameters	Ø 4 mm	Ø 6 mm	Ø 8 mm
Maximum working pressure	- 20° / + 40°	16 bar	16 bar
	+ 40° / + 60°	16 bar	16 bar
	+ 60° / + 80°	16 bar	15 bar
Presión de trabajo mín.	-0,9 bar		
Temperatura	-20 ÷ +80 (ver las características del tubo usado)		
Threads	Gas cilíndrica ISO-228 BSPP		
	Gas cónica ISO-7 BSPT (con junta PTFE preaplicada)		
	Métrica paralela ISO-965		
Connecting tube	Poliuretano (PU), Polietileno (PE), Poliamida (PA), Fluoropolímero (PTFE), Poliéster (HY3L), tubo metálico rígido con extremo metálico ranurado liso		
Fluido	Aire comprimido (para otros fluidos consulte a nuestros técnicos)		
Materiales	(A) Cuerpo = tecnopolímero (PA66), latón niquelado		
	(B) Boquilla = tecnopolímero (PA66)		
	(C) Anillo de sujeción = acero inoxidable (AISI 301)		
	(D) Juntas = NBR		
	(E) Rosca = latón niquelado		

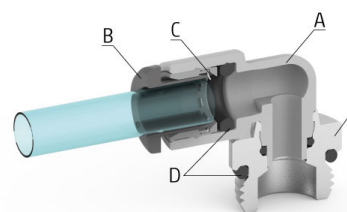

RACORES SUPER RÁPIDOS GRIPFIT
SERIE 7000 - AUTOMATIZACIÓN - DIMENSIONES
Conector recto macho Mod. G6510

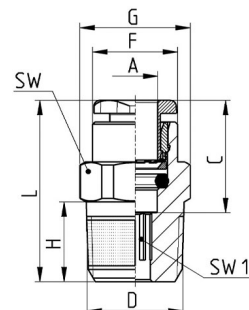
 Latón niquelado
 Rosca BSPT ISO-7 (con junta PTFE preaplicada)

Mod.	A	D	C	F	G	H	L	SW	SW1	Peso [g]
G6510 4-1/8	4	R1/8	14,6	8,8	13,2	7,5	19,5	12	2,5	8
G6510 4-1/4	4	R1/4	14,6	8,8	15,2	11	23	14	2,5	12
G6510 6-1/8	6	R1/8	15,5	11,7	13,2	7,5	21,5	12	4	8
G6510 6-1/4	6	R1/4	15,5	11,7	15,2	11	25	14	4	11
G6510 6-3/8	6	R3/8	15,5	11,7	20,5	11,5	25,5	19	4	22
G6510 6-1/2	6	R1/2	15,5	11,7	24,5	14	28	22	4	34
G6510 8-1/8	8	R1/8	16,8	13,7	15,2	7,5	27	14	5	12
G6510 8-1/4	8	R1/4	16,8	13,7	15,2	11	27	14	6	14
G6510 8-3/8	8	R3/8	16,8	13,7	20,5	11,5	27	19	6	24
G6510 8-1/2	8	R1/2	16,8	13,7	24,5	14	29,5	22	6	37

Conector recto macho Mod. G6512

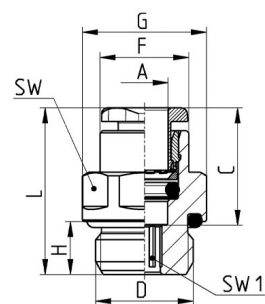
 Latón niquelado
 Rosca métrica paralela ISO-965 y BSPP ISO-228

Mod.	A	D	C	F	G	H	L	SW	SW1	Peso (g)
G6512 4-M5	4	M5	14,6	8,8	9,9	4	20,5	9	2	3
G6512 4-1/8	4	G1/8	14,6	8,8	13,5	6	20	12	2,5	8
G6512 4-1/4	4	G1/4	14,6	8,8	16,4	7	21,5	15	2,5	12
G6512 6-M5	6	M5	15,5	11,7	13,2	4	21,5	12	2	6
G6512 6-M10x1	6	M10x1	15,5	11,7	13,5	6	21,5	12	4	8
G6512 6-M12x1,25	6	M12x1,25	15,5	11,7	15,4	7	22	14	4	12
G6512 6-1/8	6	G1/8	15,5	11,7	13,5	6	21	12	4	8
G6512 6-1/4	6	G1/4	15,5	11,7	16,4	7	22	15	4	11
G6512 6-3/8	6	G3/8	15,5	11,7	20,5	7	22,5	19	4	22
G6512 6-1/2	6	G1/2	15,5	11,7	24,5	8	24	22	4	34
G6512 8-M10x1	8	M10x1	17,3	13,7	15,4	6	26	14	5	12
G6512 8-M12x1,25	8	M12x1,25	17,3	13,7	15,4	7	24,5	14	6	14
G6512 8-1/8	8	G1/8	17,3	13,7	15,2	6	26	14	5	12
G6512 8-1/4	8	G1/4	17,3	13,7	16,4	7	24,5	15	6	14
G6512 8-3/8	8	G3/8	17,3	13,7	20,5	7	24	19	7	24
G6512 8-1/2	8	G1/2	17,3	13,7	24,5	8	25,5	22	6	37

Conector recto macho Mod. G6512_M

Latón niquelado
Rosca métrica paralela ISO-965 y BSPP ISO-228

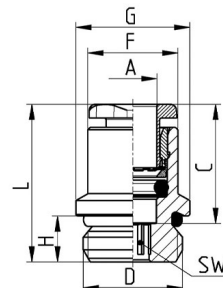

Mod.	A	D	C	F	G	H	L	SW	Peso (g)
G6512 4-M5-M	4	M5	14,6	8,8	7,8	4	20,5	2	3
G6512 4-M7-M	4	M7x1	14,6	8,8	9,4	5	18,5	2,5	3
G6512 4-1/8-M	4	G1/8	14,6	8,8	11,2	5	18,8	2,5	6
G6512 6-M5-M	6	M5	15,5	10,4	7,8	4	21,5	2	4
G6512 6-M7-M	6	M7	15,5	10,4	9,4	5	22,5	4	5
G6512 6-1/8-M	6	G1/8	15,5	11,2	11,2	5	19,5	4	5
G6512 6-1/4-M	6	G1/4	15,5	11,7	14,8	6	20,5	4	9

Conector recto hembra Mod. G6463

Latón niquelado
Rosca métrica paralela ISO-965 y BSPP ISO-228

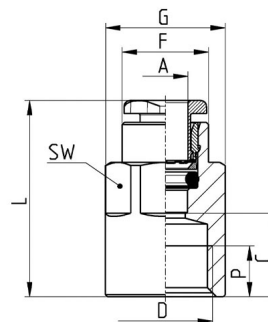

Mod.	A	D	C	F	G	L	P (min)	SW	Peso (g)
G6463 4-M5	4	M5	7,5	8,8	9,8	21,5	4,5	9	5,5
G6463 4-1/8	4	G1/8	10,5	8,8	13	24,5	6	12	13,5
G6463 4-1/4	4	G1/4	12,5	8,8	16,5	26,5	7	15	23
G6463 6-1/8	6	G1/8	10	11,7	13	25,5	6	12	13
G6463 6-1/4	6	G1/4	11,5	11,9	16,5	27	7	15	21,5
G6463 8-1/8	8	G1/8	9,5	13,7	15,2	27	6	14	13,5
G6463 8-1/4	8	G1/4	11,5	13,7	16,5	29	7	15	20,5
G6463 8-3/8	8	G3/8	12,5	13,7	20,5	30	8	19	25

RACORES SUPER RÁPIDOS GRIPFIT
SERIE 7000 - AUTOMATIZACIÓN - DIMENSIONES
Adaptador recto macho Mod. G6812

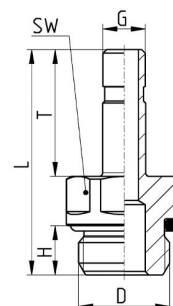
 Latón niquelado
 Rosca métrica paralela ISO-965 y BSPP ISO-228

Mod.	D	G	H	L	T	SW	Peso (g)
G6812 4-M5	M5	4	4	25	16,5	8	3,5
G6812 4-1/8	G1/8	4	6	28,5	16,5	12	9,5
G6812 6-M5	M5	6	4	26,5	18	8	4,4
G6812 6-1/8	G1/8	6	6	30	18	12	9,2
G6812 6-1/4	G1/4	6	7	32	18	15	17,4
G6812 6-3/8	G3/8	6	7	32	18	19	23,9
G6812 8-1/8	G1/8	8	6	32,5	20,5	12	10,2
G6812 8-1/4	G1/4	8	7	34,5	20,5	15	17,4
G6812 8-3/8	G3/8	8	7	34,5	20,5	19	25

Codo giratorio hembra Mod. G7523

Rosca BSPP ISO-228

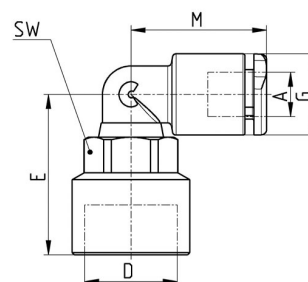

Mod.	A	D	E	G	M	SW	Peso (g)
G7523 4-1/8	4	G1/8	20	9,2	17	12	7
G7523 4-1/4	4	G1/4	21,5	9,2	17	12	10
G7523 6-1/8	6	G1/8	21	11,4	19	12	8
G7523 6-1/4	6	G1/4	21	11,4	19	12	11
G7523 8-1/8	8	G1/8	22,5	13,7	21,5	12	11
G7523 8-1/4	8	G1/4	24,5	13,7	21,5	15	13
G7523 8-3/8	8	G3/8	26	13,7	21,5	15	21

Codo macho giratorio Mod. G7520

Rosca BSPT ISO-7 (con junta PTFE preaplicada)

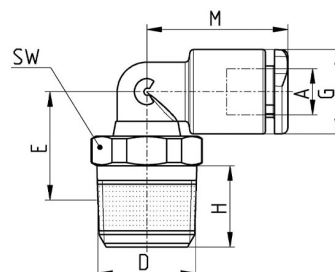

	A	D	E	G	H	M	SW	Peso (g)
G7520 4-1/8	4	R1/8	12,2	9,2	7,5	17	12	7
G7520 4-1/4	4	R1/4	14,5	9,2	11	17	14	10
G7520 6-1/8	6	R1/8	13,2	11,4	7,5	19	12	8
G7520 6-1/4	6	R1/4	15,5	11,4	11	19	14	11
G7520 6-3/8	6	R3/8	16,7	11,4	11,5	19	19	18
G7520 6-1/2	6	R1/2	18,5	11,4	14	19	22	20
G7520 8-1/8	8	R1/8	13,6	13,7	7,5	21,5	12	11
G7520 8-1/4	8	R1/4	14,2	13,7	11	21,5	14	13
G7520 8-3/8	8	R3/8	18,5	13,7	11,5	21,5	19	21

Codo macho giratorio Mod. G7522

Rosca métrica paralela ISO-965 y BSPP ISO-228

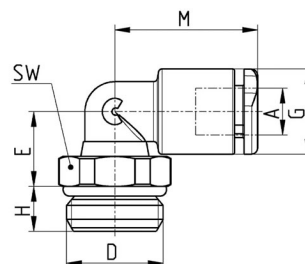

Mod.	A	D	E	G	H	M	SW	Peso (g)
G7522 4-M5	4	M5	8,2	9,2	3,5	17	9	4
G7522 4-M7	4	M7	11	9,2	5	17	10	6
G7522 4-1/8	4	G1/8	9	9,2	5	17	12	7
G7522 4-1/4	4	G1/4	9	9,2	6	17	14	10
G7522 6-M5	6	M5	9,2	11,4	3,5	19	9	5
G7522 6-M7	6	M7	12	11,4	5	19	10	7
G7522 6-M10x1	6	M10x1	12,2	11,4	5	19	12	8
G7522 6-M12x1,25	6	M12x1,25	10	11,4	6	19	14	11
G7522 6-1/8	6	G1/8	10	11,4	5	19	12	8
G7522 6-1/4	6	G1/4	10	11,4	6	19	14	11
G7522 6-3/8	6	G3/8	10	11,4	7	19	19	16
G7522 6-1/2	6	G1/2	10	11,4	8	19	24	15
G7522 8-M10x1	8	M10x1	13,5	13,7	5	21,5	12	11
G7522 8-M12x1,25	8	M12x1,25	12	13,7	6	21,5	14	14
G7522 8-1/8	8	G1/8	13,5	13,7	5	21,5	12	11
G7522 8-1/4	8	G1/4	12	13,7	6	21,5	14	14
G7522 8-3/8	8	G3/8	12	13,7	7	21,5	19	19

RACORES SUPER RÁPIDOS GRIPFIT
SERIE 7000 - AUTOMATIZACIÓN - DIMENSIONES
Codo largo macho giratorio Mod. G7527

Rosca BSPT ISO-7 (con junta PTFE preaplicada)

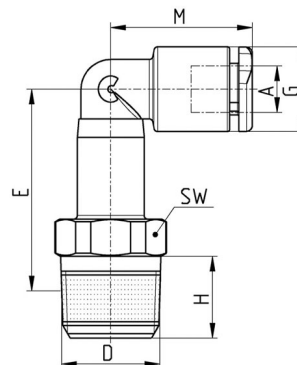

Mod.	A	D	E	G	H	M	SW	Peso (g)
G7527 4-1/8	4	R1/8	25,2	9,2	7,5	17	12	12
G7527 6-1/8	6	R1/8	26,2	11,4	7,5	19	12	13
G7527 6-1/4	6	R1/4	28	11,4	11	19	12	16
G7527 8-1/8	8	R1/8	32,4	13,7	7,5	21,5	12	18
G7527 8-1/4	8	R1/4	32,2	13,7	11	21,5	14	20

RACORES, CONECTORES Y TUBOS

Codo largo macho giratorio Mod. G7526

Rosca métrica paralela ISO-965 y BSPP ISO-228

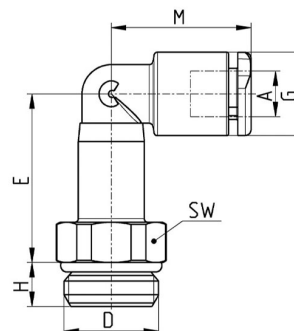

Mod.	A	D	E	G	H	M	SW	Peso (g)
G7526 4-M5	4	M5	24,6	9,2	3,5	17	10	9
G7526 4-1/8	4	G1/8	22	9,2	5	17	12	12
G7526 4-1/4	4	G1/4	22	9,2	6	17	14	14
G7526 6-M5	6	M5	25	11,4	5	19	10	10
G7526 6-M7*	6	M7	25	11,4	5	19	10	11
G7526 6-1/8	6	G1/8	23	11,4	5	19	12	13
G7526 6-1/4	6	G1/4	23	11,4	6	19	14	16
G7526 8-1/8	8	G1/8	29	13,7	5	21,5	12	18
G7526 8-1/4	8	G1/4	27	13,7	6	21,5	14	20

* Por encargo

T central macho giratorio Mod. G7430

Rosca BSPT ISO-7 (con junta PTFE preaplicada)

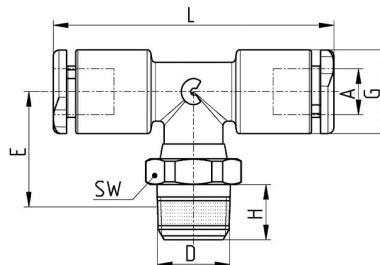

Mod.	A	D	E	G	H	L	SW	Peso (g)
G7430 4-1/8	4	R1/8	14,8	9,2	7,5	34	12	9
G7430 6-1/8	6	R1/8	16,3	11,4	7,5	38	12	11
G7430 6-1/4	6	R1/4	16,3	11,4	11	38	14	13
G7430 8-1/8	8	R1/8	19,1	13,7	7,5	43	12	15
G7430 8-1/4	8	R1/4	19,2	13,7	11	43	14	17

T central macho giratorio Mod. G7432

Rosca métrica paralela ISO-965 y BSPP ISO-228

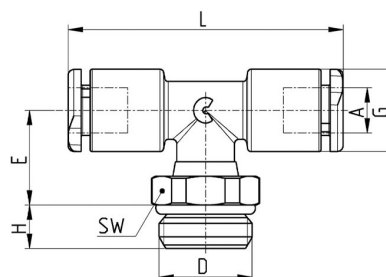

Mod.	A	D	E	G	H	L	SW	Peso (g)
G7432 4-M5	4	M5	14	9,2	3,5	34	9	7
G7432 4-1/8	4	G1/8	11,6	9,2	5	34	12	9
G7432 6-M5	6	M5	15,5	11,4	3,5	38	9	9
G7432 6-1/8	6	G1/8	13	11,4	5	38	12	11
G7432 6-1/4	6	G1/4	13	11,4	6	38	14	13
G7432 8-1/8	8	G1/8	16	13,7	5	43	12	15
G7432 8-1/4	8	G1/4	14,5	13,7	6	43	14	17
G7432 8-3/8	8	G3/8	15,5	13,7	7	43	19	25

RACORES SUPER RÁPIDOS GRIPFIT
SERIE 7000 - AUTOMATIZACIÓN - DIMENSIONES
T lateral macho giratorio Mod. G7440

Rosca BSPT ISO-7 (con junta PTFE preaplicada)

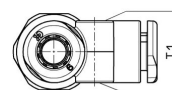
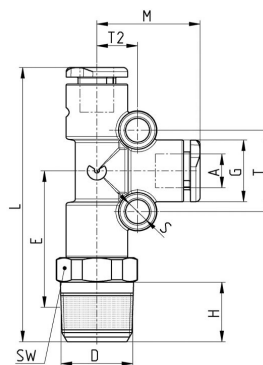

Mod.	A	D	E	G	H	L	M	S	T	T1	T2	SW	Peso (g)
G7440 4-1/8	4	R1/8	22,2	9,2	7,5	42,5	17	4	13	9,2	6,5	12	11
G7440 6-1/8	6	R1/8	23,7	11,4	7,5	46,5	19	4	15	11,4	7,5	12	15
G7440 6-1/4	6	R1/4	26	11,4	11	50,5	19	4	15	11,4	7,5	14	18
G7440 8-1/8	8	R1/8	26,2	13,7	7,5	49	21,5	4	17	13,7	8,5	14	23
G7440 8-1/4	8	R1/4	28	13,7	11	54,5	21,5	4	17	13,7	8,5	14	22

RACORES, CONECTORES Y TUBOS

10

T lateral macho giratorio Mod. G7442

Rosca métrica paralela ISO-965 y BSPP ISO-228

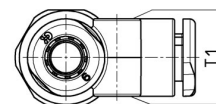
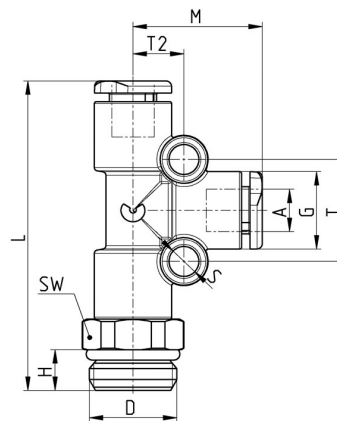

Mod.	A	D	G	H	L	M	S	T	T1	T2	SW	Peso (g)
G7442 4-M5	4	M5	9,2	3,5	39	17	4	13	9,2	6,5	10	9
G7442 4-1/8	4	G1/8	9,2	5	40,5	17	4	13	9,2	6,5	12	11
G7442 6-M5	6	M5	11,4	3,5	43	19	4	15	11,4	7,5	12	10
G7442 6-1/8	6	G1/8	11,4	5	44,5	19	4	15	11,4	7,5	12	15
G7442 6-1/4	6	G1/4	11,4	6	45,5	19	4	15	11,4	7,5	14	18
G7442 8-1/8	8	G1/8	13,7	5	50,5	21,5	4	17	13,7	8,5	14	23
G7442 8-1/4	8	G1/4	13,7	6	50,5	21,5	4	17	13,7	8,5	14	22
G7442 8-3/8	8	G3/8	13,7	7	52	21,5	4	17	13,7	8,5	19	28

Y macho giratorio Mod. G7450

Rosca BSPT ISO-7 (con junta PTFE preaplicada)

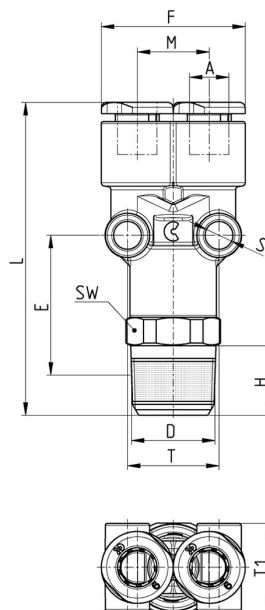

Mod.	A	D	E	F	H	L	M	S	T	T1	SW	Peso (g)
G7450 4-1/8	4	R1/8	19,7	18,5	7,5	42	9,2	4	12,2	11,6	12	13
G7450 6-1/8	6	R1/8	21,2	23	7,5	46	11,4	4	14,5	14	14	15
G7450 6-1/4	6	R1/4	23	23	11	49,5	11,4	4	14,5	14	14	29
G7450 8-1/8	8	R1/8	22,3	26	7,5	51,3	12,7	4	16,5	15,5	17	24
G7450 8-1/4	8	R1/4	24,1	26	11	54,8	12,7	4	16,5	15,5	17	30

Y macho giratorio Mod. G7562

Rosca BSPP ISO-228

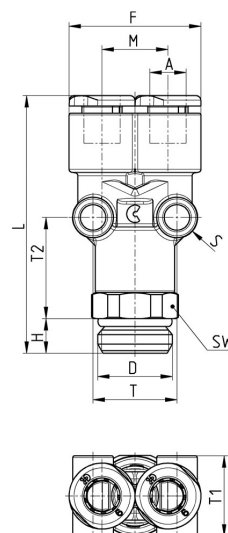

Mod.	A	D	F	H	L	M	S	T	T1	T2	SW	Peso (g)
G7562 4-1/8	4	G1/8	18,2	5	40,5	9,2	4	12,2	11,6	16,5	12	13
G7562 6-1/8	6	G1/8	23	5	44,5	11,4	4	14,5	14	18,5	14	15
G7562 6-1/4	6	G1/4	23	6	44,5	11,4	4	14,5	14	17,5	14	29
G7562 8-1/8	8	G1/8	26	5	48,5	12,7	4	16,5	15,5	20	14	24
G7562 8-1/4	8	G1/4	26	6	50	12,7	4	16,5	15,5	19,5	17	30

RACORES SUPER RÁPIDOS GRIPFIT
SERIE 7000 - AUTOMATIZACIÓN - DIMENSIONES

Y doble macho giratorio Mod. G7572

Rosca BSPP ISO-228

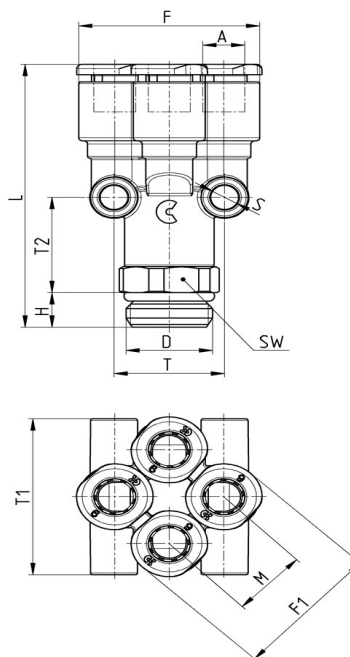

Mod.	A	D	F	F1	H	L	M	S	T	T1	T2	SW	Peso (g)
G7572 4-1/8	4	G1/8	22	18	5	40	9,3	4	14,5	22	15	12	17,5
G7572 4-1/4	4	G1/4	22	18	6	41	9,3	4	14,5	22	15	14	21,5
G7572 6-1/8	6	G1/8	27	22	5	45,5	11,5	4	16,5	27	17,5	14	17,5
G7572 6-1/4	6	G1/4	27	22	6	45,5	11,5	4	16,5	27	16,5	14	25,5

Anillo simple macho giratorio Mod. G7622

Anillo simple macho giratorio
 Rosca métrica paralela ISO-965 y BSPP ISO-228

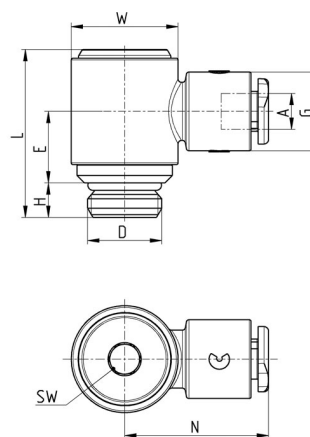

Mod.	A	D	E	G	H	L	N	W	SW	Peso (g)
G6622 4-M5*	4	M5	6	8,6	4	15,8	19	8,5	2,5	6
G7622 4-1/8	4	G1/8	10	11,4	5	24,5	21	14	4	12
G6622 6-M5*	6	M5	7	11,7	4	15,8	22,5	8,5	2,5	10
G7622 6-1/8	6	G1/8	10	11,4	5	24,5	21,5	14	4	12
G7622 6-1/4	6	G1/4	12,5	13,7	6	28	25	18,5	5	25
G7622 8-1/8	8	G1/8	10	13,7	5	24,5	23,5	14	4	14
G7622 8-1/4	8	G1/4	12,5	13,7	6	28	25,5	18,5	5	26

* Cuerpo en latón

RACORES, CONECTORES Y TUBOS

10

Racores Mod. G7652

Rosca BSPP ISO-228

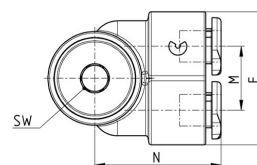
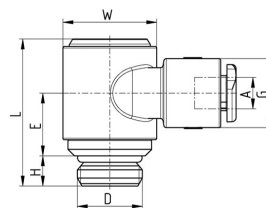

Mod.	A	D	E	F	G	H	L	M	N	W	SW	Peso (g)
G7652 4-1/8	4	G1/8	10	22,3	11,4	5	24,5	10,7	21	14	4	15
G7652 6-1/8	6	G1/8	10	22,3	11,4	5	24,5	10,7	21,5	14	4	15
G7652 6-1/4	6	G1/4	11,5	26,6	13,7	6	28	12,7	25	18	5	29
G7652 8-1/8	8	G1/8	10	26,6	13,7	5	24,5	12,7	23	14	4	18
G7652 8-1/4	8	G1/4	11,5	26,6	13,7	6	28	12,7	25,5	18	5	30

Anillo ajustable simple doble macho Mod. G7612 02

Rosca BSPP ISO-228

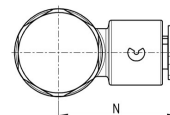
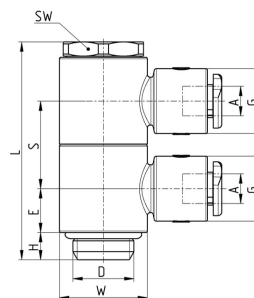

Mod.	A	D	E	G	H	L	N	S	W	SW	Peso (g)
G7612 02 4-1/8	4	G1/8	7,75	11,4	5	38,5	21	15,5	14	13	21
G7612 02 6-1/8	6	G1/8	7,75	11,4	5	38,5	21,5	15,5	14	13	21
G7612 02 6-1/4	6	G1/4	9,25	13,7	6	46	25	18,5	18,5	17	40
G7612 02 8-1/8	8	G1/8	7,75	13,7	5	38,5	23,5	15,5	14	13	24
G7612 02 8-1/4	8	G1/4	9,25	13,7	6	46	23,5	18,5	18,5	17	42

RACORES SUPER RÁPIDOS GRIPFIT
SERIE 7000 - AUTOMATIZACIÓN - DIMENSIONES
Anillo ajustable simple triple macho Mod. G7612 03

Rosca BSPP ISO-228

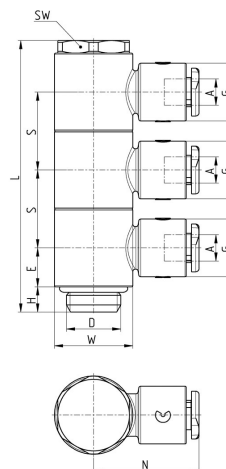

Mod.	A	D	E	G	H	L	N	S	W	SW	Peso (g)
G7612 03 4-1/8	4	G1/8	7,75	11,4	5	54	21	15,5	14	13	29
G7612 03 6-1/8	6	G1/8	7,75	11,4	5	54	21,5	15,5	14	13	30
G7612 03 6-1/4	6	G1/4	9,25	13,7	6	64,5	25	18,5	18,5	17	55
G7612 03 8-1/8	8	G1/8	7,75	13,7	5	54	23,5	15,5	14	13	34
G7612 03 8-1/4	8	G1/4	9,25	13,7	6	64,5	25,5	18,5	18,5	17	57

RACORES, CONECTORES Y TUBOS

10
Anillo ajustable Y doble macho Mod. G7642 02

Rosca BSPP ISO-228

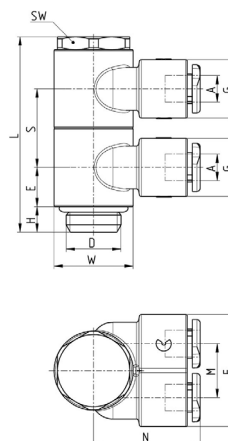

Mod.	A	D	E	F	G	H	L	M	N	S	W	SW	Peso (g)
G7642 02 4-1/8	4	G1/8	7,75	22,3	11,4	5	38,5	10,7	21	15,5	14	13	26
G7642 02 6-1/8	6	G1/8	7,75	22,3	11,4	5	38,5	10,7	21,5	15,5	14	13	28
G7642 02 6-1/4	6	G1/4	9,25	26,6	13,7	6	46	12,7	25	18,5	18,5	17	48
G7642 02 8-1/8	8	G1/8	7,75	26,6	13,7	5	38,5	12,7	23	15,5	14	13	33
G7642 02 8-1/4	8	G1/4	9,25	26,6	13,7	6	46	12,7	25,5	18,5	18,5	17	50

Anillo ajustable Y triple macho Mod. G7642 03

Rosca BSPP ISO-228

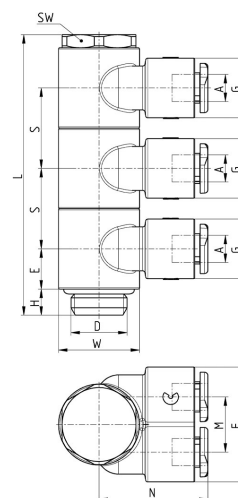

Mod.	A	D	E	F	G	H	L	M	N	S	W	SW	Peso (g)
G7642 03 4-1/8	4	G1/8	7,75	22,3	11,4	5	54	10,7	21	15,5	14	13	37
G7642 03 6-1/8	6	G1/8	7,75	22,3	11,4	5	54	10,7	21,5	15,5	14	13	39
G7642 03 6-1/4	6	G1/4	9,25	26,6	13,7	6	64,5	12,7	25	18,5	18,5	17	67
G7642 03 8-1/8	8	G1/8	7,75	26,6	13,7	5	54	12,7	23	15,5	14	13	47
G7642 03 8-1/4	8	G1/4	9,25	26,6	13,7	6	64,5	12,7	25,5	18,5	18,5	17	71

Anillo simple Mod. G7610

Para montarse con Mod. 7632 02*, Mod. 7632 03*.

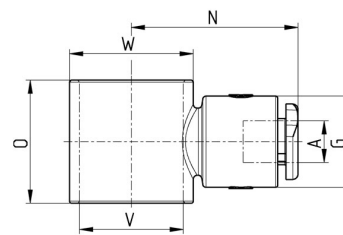

Mod.	A	G	N	O	V	W	Peso (g)
G7610 4-1/8	4	11,4	21	15,5	11	14	6
G7610 6-1/8	6	11,4	21,5	15,5	11	14	7
G7610 6-1/4	6	13,7	25	18,5	15,5	18,5	9
G7610 8-1/8	8	13,7	23,5	15,5	11	14	10
G7610 8-1/4	8	13,7	25,5	18,5	18,5	18,5	10

Anillo doble Mod. G7640

Para montarse con Mod. 7632 02*, Mod. 7632 03*.

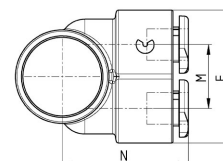
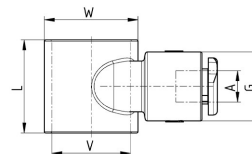

Mod.	A	F	G	L	M	N	V	W	Peso (g)
G7640 4-1/8	4	22,3	11,4	15,5	10,7	21	11	14	6
G7640 6-1/8	6	22,3	11,4	15,5	10,7	21,5	11	14	7
G7640 6-1/4	6	26,6	13,7	18,5	12,7	25	15,5	18,5	9
G7640 8-1/8	8	26,6	13,7	18,5	12,7	23	11	14	10
G7640 8-1/4	8	26,6	13,7	18,5	12,7	25,5	15,5	18,5	10

RACORES, CONECTORES Y TUBOS

Tornillo doble para anillo Mod. 7632 02*

Para montarse con Mod. G7610., Mod. G7640.

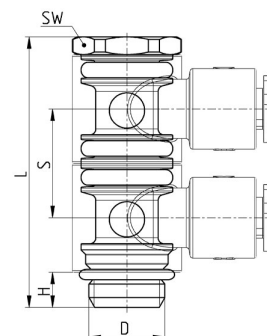

Mod.	D	H	L	S	SW	Peso (g)
7632 02-1/8	G1/8	5	38,5	15,5	13	13,5
7632 02-1/4	G1/4	6	46	18,5	17	29

10

**RACORES SUPER RÁPIDOS GRIPFIT
SERIE 7000 - AUTOMATIZACIÓN - DIMENSIONES**

Tornillo triple para anillo Mod. 7632 03*

Para montarse con Mod. G7610., Mod. G7640.

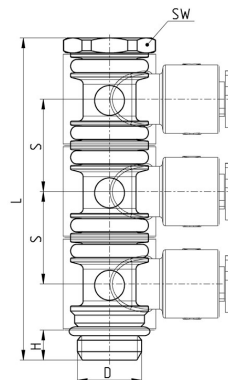

Mod.	D	H	L	S	SW	Peso (g)
7632 03-1/8	G1/8	5	54	15,5	13	17,5
7632 03-1/4	G1/4	6	64,5	18,5	17	38

Codo de unión igual y reductor Mod. G7555

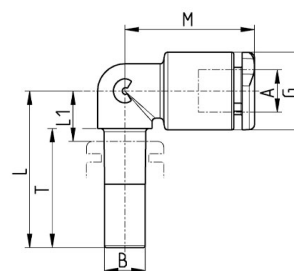

Mod.	A	B	G	L	L1	M	T	Peso (g)
G7555 4-4	4	4	9,2	21	7	17	16,5	2
G7555 4-6	4	6	9,2	23	8	17	18,5	3
G7555 6-4	6	4	11,4	22	7	19	16,5	3
G7555 6-6	6	6	11,4	23	8	19	17,5	4
G7555 6-8	6	8	11,4	24	9	19	18,5	4
G7555 8-6	8	6	13,7	24	8	21,5	17,5	4
G7555 8-8	8	8	13,7	25	9	21,5	18,5	5

Adaptador T central Mod. G7435

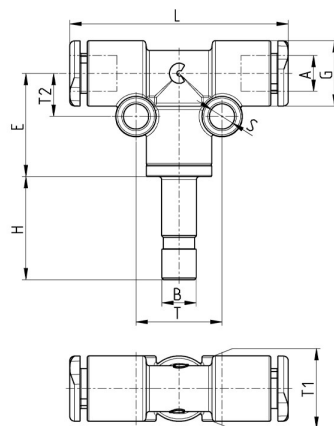

Mod.	A	B	E	G	H	L	S	T	T1	T2	Peso (g)
G7435 4-4	4	4	16,5	9,2	16,5	34	4	13	9,2	6,5	11
G7435 6-6	6	6	18	11,4	18	38	4	15	11,4	7,5	15
G7435 8-8	8	8	20	13,7	20,5	43	4	17	13,7	8,5	23

RACORES, CONECTORES Y TUBOS

Adaptador T lateral Mod. G7445

10

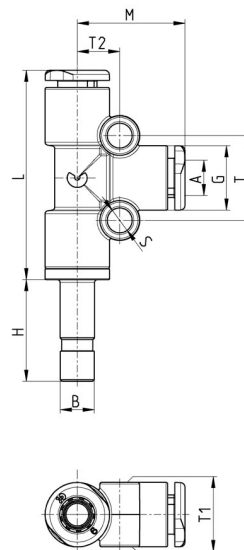

Mod.	A	B	G	H	L	M	S	T	T1	T2	Peso (g)
G7445 4-4	4	4	9,2	16,5	33	17	4	13	9,2	6,5	11
G7445 6-6	6	6	11,4	18	37	19	4	15	11,4	7,5	15
G7445 8-8	8	8	13,7	20,5	42	21,5	4	17	13,7	8,5	23

Adaptador Y central Mod. G7565

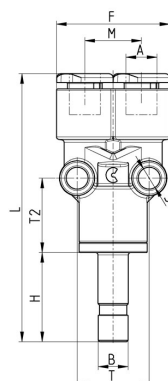

Mod.	A	B	F	H	L	M	S	T	T1	T2	Peso (g)
G7565 4-4	4	4	18,2	16,5	49,5	9	4	10,8	9,5	14	8
G7565 6-6	6	6	23	18	54	11,4	4	14,5	11,5	15	11
G7565 8-8	8	8	27,2	20,5	60,5	13,5	4	17	14	14	17

Unión reductora recta Mod. G7800

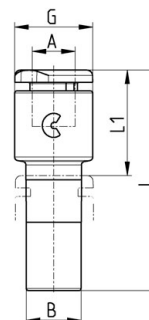

Mod.	A	B	G	L	L1	Peso (g)
G7800 4-6	4	6	9,3	29,5	14	2
G7800 4-8	4	8	9,3	30,5	14	3
G7800 6-8	6	8	11,4	32,5	15,5	4
G7800 6-10	6	10	11,4	34,5	15,5	4
G7800 6-12	6	12	11,4	36,2	15,5	4
G7800 8-10	8	10	13,7	36,2	17,2	5
G7800 8-12	8	12	13,7	37,9	17,2	6

RACORES SUPER RÁPIDOS GRIPFIT
SERIE 7000 - AUTOMATIZACIÓN - DIMENSIONES

Pasamuros Mod. G6590



Latón niquelado
 Rosca métrica paralela ISO-965

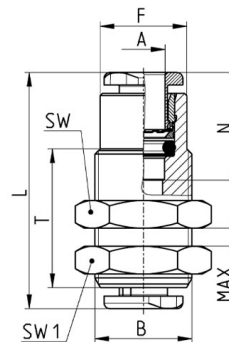

Mod.	A	B	F	L	MAX	N	T	SW	SW1	Peso [g]
G6590 4	4	M10x1	8,8	28	10,5	14,6	20	14	14	9,5
G6590 6	6	M14x1	12,5	31	10,5	15,5	20	17	17	21
G6590 8	8	M16x1	14,5	34,5	11,5	17,3	21	19	19	26

RACORES, CONECTORES Y TUBOS

Unión recta igual y reductora Mod. G7580

10

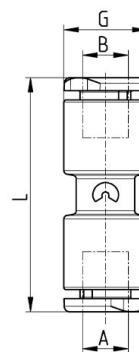

Mod.	A	B	G	L	Peso (g)
G7580 4	4	4	9,2	29,2	4
G7580 4-6	4	6	11,4	31,5	5
G7580 4-8	4	8	13,7	34,4	5
G7580 6	6	6	11,4	32	6
G7580 6-8	6	8	13,7	34,9	7
G7580 8	8	8	13,7	35,4	8

Codo unión igual y reductor Mod. G7550

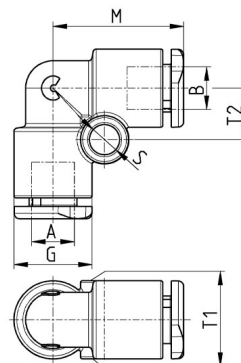

Mod.	A	B	G	M	S	T1	T2	Peso (g)
G7550 4	4	4	9,2	17	4	9,2	6,5	4
G7550 4-6	4	6	11,4	19	4	11,4	7,5	5
G7550 6	6	6	11,4	19	4	11,4	7,5	6
G7550 6-8	6	8	13,7	21,5	4	13,7	8,5	8
G7550 8	8	8	13,7	21,5	4	13,7	8,5	9

T unión igual y reductor Mod. G7540

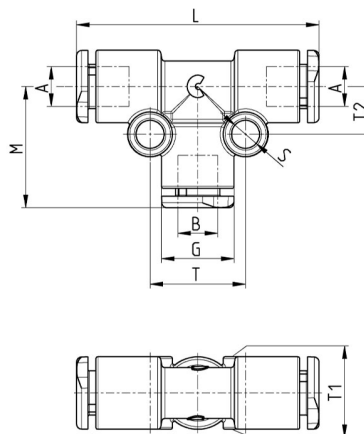

Mod.	A	B	G	L	M	S	T	T1	T2	Peso (g)
G7540 4	4	4	9,2	34	17	4	12	9,2	6,5	6
G7540 6	6	6	11,4	38	19	4	15	11,4	7,5	9
G7540 6-6-4	6	4	11,4	38	19	4	15	11,4	7,5	8
G7540 8	8	8	13,7	43	21,5	4	17	13,7	8,5	14
G7540 8-8-4	8	4	13,7	43	21,5	4	17	13,7	8,5	12
G7540 8-8-6	8	6	13,7	43	21,5	4	17	13,7	8,5	13

RACORES SUPER RÁPIDOS GRIPFIT

SERIE 7000 - AUTOMATIZACIÓN - DIMENSIONES

T múltiple unión reductor Mod. G7545

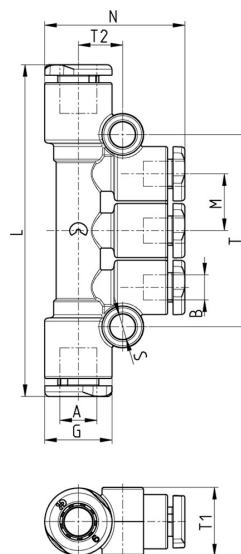

Mod.	A	B	G	L	M	N	S	T	T1	T2	Peso (g)
G7545 6-4	6	4	11,4	56	9,6	26,7	4	32,5	11,6	7,5	12
G7545 8-4	8	4	13,7	66	11,5	27	4	38,2	13,7	8	16
G7545 8-6	8	6	13,7	66	11,5	27	4	38,2	13,7	9	18

RACORES, CONECTORES Y TUBOS

Y unión igual y reductor Mod. G7560

10

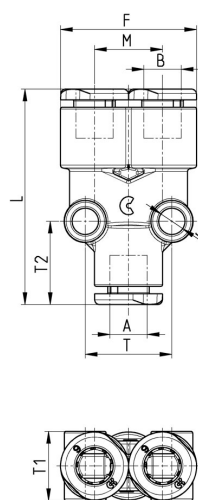

Mod.	A	B	F	L	M	S	T	T1	T2	Peso (g)
G7560 4	4	4	18,2	33,2	9	4	10,8	9,5	13	6
G7560 6	6	6	23	36	11,4	4	14,5	11,5	14	9
G7560 6-4	6	4	18,2	34	9	4	12,2	11,5	15	8
G7560 8	8	8	27,2	41,5	13,5	4	17	14	15	15
G7560 8-6	8	6	23	37,5	11,4	4	14,5	11,5	16	13

Y unión doble igual y reductor Mod. G7575

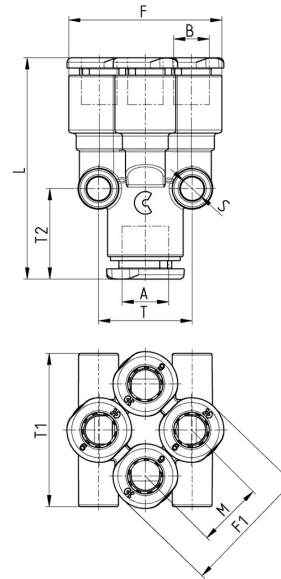

Mod.	A	B	F	F1	L	M	S	T	T1	T2	Peso (g)
G7575 4	4	4	22	18	33,1	9,3	4	14,5	22	13,5	12,5
G7575 6-4	6	4	22	18	33,6	9,3	4	14,5	22	13,5	14,5
G7575 6	6	6	27	22	38	11,5	4	16,5	27	15	17,5
G7575 8-6	8	6	27	22	38,5	11,5	4	16,5	27	15	19,5

Accesorio Mod. 6900

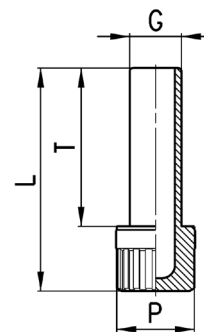

Mod.	G	L	P	T	Peso (g)
6900 4	4	29	8	20	1
6900 6	6	31,5	8	22,5	1
6900 8	8	34,5	12	24,5	2

Tapón hembra Mod. G6750

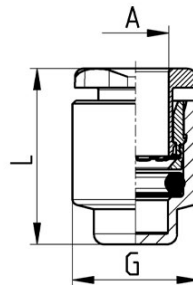

Mod.	A	G	L	Peso (g)
G6750 4	4	8,8	15,6	2,5
G6750 6	6	11,8	16,5	4,5
G6750 8	8	13,8	18,3	5,5

Ranura para tubo metálico

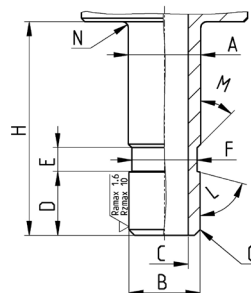
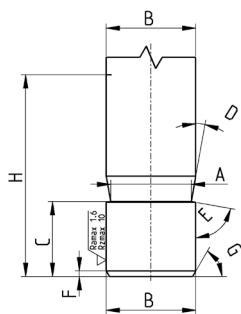

realizada con la ranuradora Camozzi 8TRT (o mecanizado)

A	B	C	D	E	F	G	H
3.4	4	5.3	10°	80°	0.5	30°	16.5
5.2	6	6.25	10°	80°	0.5	30°	18
7.2	8	6.4	10°	80°	0.5	30°	20

realizada por mecanizado

A	B	C	D	E	F	G	H	I	L	M
4.1	4	2	5.3	2	3.5	0,5x45°	16.5	75°	45°	0.5
6.1	6	4	5.4	2	5.5	0,5x45°	18	75°	45°	0.5
8.1	8	6	6	2	7.5	0,5x45°	20.5	75°	45°	0.5

Herramienta de ranurado para tubos metálicos

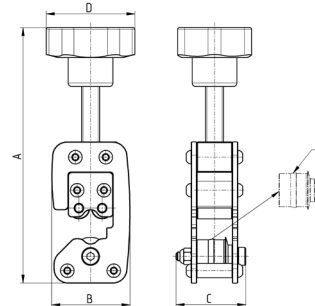

Mod.	Tubo Ø	A (max)	B	C	D	Peso [g]	E (rueda de repuesto)
8TRT 4	4	138	43,5	39	50	450	RTRT 4
8TRT 6	6	140	43,5	39	50	450	RTRT 6
8TRT 8	8	143	44	39	50	450	RTRT 8

Alargador de tecnopolímero Mod. 7950

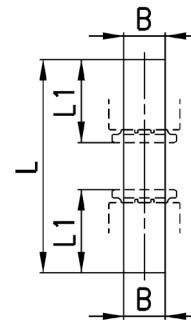

Mod.	B	L	L1	Peso (g)
7950 4	4	37	14	1
7950 6	6	39	15	1
7950 8	8	41	16	1
7950 10	10	44	18,5	1
7950 12	12	49	19	1