

GRIPFIT PUSH-IN FITTINGS

SERIES 7000 - AUTOMATION

Tube external diameters: 4, 6, 8 mm
 Fittings threads: ISO-965 Metric parallel (M5, M7, M10x1, M12x1,25),
 ISO-7 BSPT (R1/8, R1/4, R3/8, R1/2),
 ISO-228 BSPP (G1/8, G1/4, G3/8, G1/2).

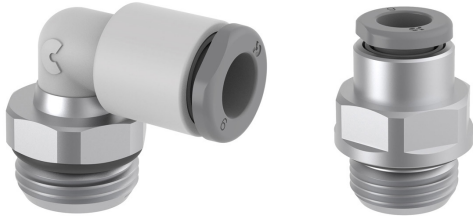

- Optimum sealing
- Maximum flow
- Compact and lightweight

Series 7000 Automation push-in fittings are made of reinforced technopolymer to meet the new market demands for reliability, ease of use and efficient solutions.

Their compact dimensions and lightweight make this new range of fittings ideal for most pneumatic applications associated with optimum gripping and sealing technologies.

General Data

Diameters		Ø 4 mm	Ø 6 mm	Ø 8 mm
Maximum working pressure	- 20° / + 40°	16 bar	16 bar	16 bar
	+ 40° / + 60°	16 bar	16 bar	14 bar
	+ 60° / + 80°	16 bar	16 bar	12 bar
Minimum working pressure		-0,9 bar		
Temperature		-20 ÷ +80 (see characteristics of tubes used)		
Threads		Cylindrical gas ISO-228 BSPP		
		Conical gas ISO-7 BSPT (with pre-applied PTFE sealant) ISO-965 Metric parallel		
Connecting tube		Polyurethane (PU), Polyethylene (PE), Polyamide (PA), Fluoropolymer (PTFE), Polyester (HY3L), rigid metal pipe with smooth grooved metal end		
Fluid		Compressed air (for other fluids consult our technicians)		
Materials	(A)	Body = technopolymer (PA66), nickel-plated brass		
	(B)	Button = technopolymer (PA66)		
	(C)	Gripping ring = Stainless steel (AISI 301)		
	(D)	Seals = NBR		
	(E)	Thread = nickel-plated brass		

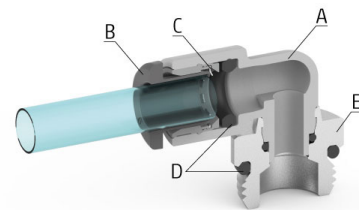

GRIPFIT PUSH-IN FITTINGS
SERIES 7000 - AUTOMATION - DIMENSIONS
Male straight connector Mod. G6510

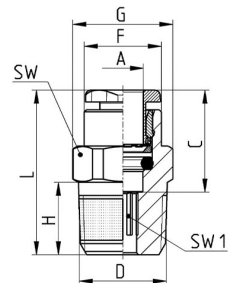
 Nickel-plated brass
 Thread BSPT ISO-7 (with pre-applied PTFE sealant)

Mod.	A	D	C	F	G	H	L	SW	SW1	Weight [g]
G6510 4-1/8	4	R1/8	14,6	8,8	13,2	7,5	19,5	12	2,5	8
G6510 4-1/4	4	R1/4	14,6	8,8	15,2	11	23	14	2,5	12
G6510 6-1/8	6	R1/8	15,5	11,7	13,2	7,5	21,5	12	4	8
G6510 6-1/4	6	R1/4	15,5	11,7	15,2	11	25	14	4	11
G6510 6-3/8	6	R3/8	15,5	11,7	20,5	11,5	25,5	19	4	22
G6510 6-1/2	6	R1/2	15,5	11,7	24,5	14	28	22	4	34
G6510 8-1/8	8	R1/8	16,8	13,7	15,2	7,5	27	14	5	12
G6510 8-1/4	8	R1/4	16,8	13,7	15,2	11	27	14	6	14
G6510 8-3/8	8	R3/8	16,8	13,7	20,5	11,5	27	19	6	24
G6510 8-1/2	8	R1/2	16,8	13,7	24,5	14	29,5	22	6	37

Male straight connector Mod. G6512

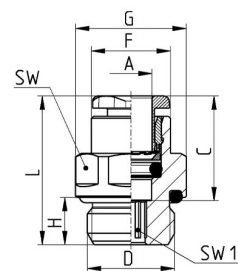
 Nickel-plated brass
 Thread metric parallel ISO-965 and BSPP ISO-228

Mod.	A	D	C	F	G	H	L	SW	SW1	Weight (g)
G6512 4-M5	4	M5	14,6	8,8	9,9	4	20,5	9	2	3
G6512 4-1/8	4	G1/8	14,6	8,8	13,5	6	20	12	2,5	8
G6512 4-1/4	4	G1/4	14,6	8,8	16,4	7	21,5	15	2,5	12
G6512 6-M5	6	M5	15,5	11,7	13,2	4	21,5	12	2	6
G6512 6-M10x1	6	M10x1	15,5	11,7	13,5	6	21,5	12	4	8
G6512 6-M12x1,25	6	M12x1,25	15,5	11,7	15,4	7	22	14	4	12
G6512 6-1/8	6	G1/8	15,5	11,7	13,5	6	21	12	4	8
G6512 6-1/4	6	G1/4	15,5	11,7	16,4	7	22	15	4	11
G6512 6-3/8	6	G3/8	15,5	11,7	20,5	7	22,5	19	4	22
G6512 6-1/2	6	G1/2	15,5	11,7	24,5	8	24	22	4	34
G6512 8-M10x1	8	M10x1	17,3	13,7	15,4	6	26	14	5	12
G6512 8-M12x1,25	8	M12x1,25	17,3	13,7	15,4	7	24,5	14	6	14
G6512 8-1/8	8	G1/8	17,3	13,7	15,2	6	26	14	5	12
G6512 8-1/4	8	G1/4	17,3	13,7	16,4	7	24,5	15	6	14
G6512 8-3/8	8	G3/8	17,3	13,7	20,5	7	24	19	7	24
G6512 8-1/2	8	G1/2	17,3	13,7	24,5	8	25,5	22	6	37

Male straight connector Mod. G6512_M

Nickel-plated brass
Thread metric parallel ISO-965 and BSPP ISO-228

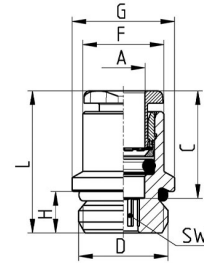

Mod.	A	D	C	F	G	H	L	SW	Weight (g)
G6512 4-M5-M	4	M5	14,6	8,8	7,8	4	20,5	2	3
G6512 4-M7-M	4	M7x1	14,6	8,8	9,4	5	18,5	2,5	3
G6512 4-1/8-M	4	G1/8	14,6	8,8	11,2	5	18,8	2,5	6
G6512 6-M5-M	6	M5	15,5	10,4	7,8	4	21,5	2	4
G6512 6-M7-M	6	M7	15,5	10,4	9,4	5	22,5	4	5
G6512 6-1/8-M	6	G1/8	15,5	11,2	11,2	5	19,5	4	5
G6512 6-1/4-M	6	G1/4	15,5	11,7	14,8	6	20,5	4	9

Female straight connector Mod. G6463

Nickel-plated brass
Thread metric parallel ISO-965 and BSPP ISO-228

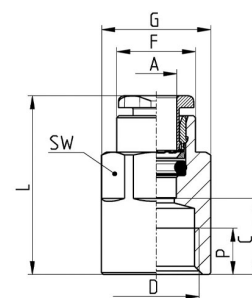

Mod.	A	D	C	F	G	L	P (min)	SW	Weight (g)
G6463 4-M5	4	M5	7,5	8,8	9,8	21,5	4,5	9	5,5
G6463 4-1/8	4	G1/8	10,5	8,8	13	24,5	6	12	13,5
G6463 4-1/4	4	G1/4	12,5	8,8	16,5	26,5	7	15	23
G6463 6-1/8	6	G1/8	10	11,7	13	25,5	6	12	13
G6463 6-1/4	6	G1/4	11,5	11,9	16,5	27	7	15	21,5
G6463 8-1/8	8	G1/8	9,5	13,7	15,2	27	6	14	13,5
G6463 8-1/4	8	G1/4	11,5	13,7	16,5	29	7	15	20,5
G6463 8-3/8	8	G3/8	12,5	13,7	20,5	30	8	19	25

GRIPFIT PUSH-IN FITTINGS
SERIES 7000 - AUTOMATION - DIMENSIONS
Male straight adaptor Mod. G6812

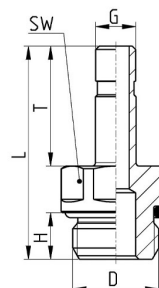
 Nickel-plated brass
 Thread metric parallel ISO-965 and BSPP ISO-228

Mod.	D	G	H	L	T	SW	Weight (g)
G6812 4-M5	M5	4	4	25	16,5	8	3,5
G6812 4-1/8	G1/8	4	6	28,5	16,5	12	9,5
G6812 6-M5	M5	6	4	26,5	18	8	4,4
G6812 6-1/8	G1/8	6	6	30	18	12	9,2
G6812 6-1/4	G1/4	6	7	32	18	15	17,4
G6812 6-3/8	G3/8	6	7	32	18	19	23,9
G6812 8-1/8	G1/8	8	6	32,5	20,5	12	10,2
G6812 8-1/4	G1/4	8	7	34,5	20,5	15	17,4
G6812 8-3/8	G3/8	8	7	34,5	20,5	19	25

FITTINGS, CONNECTORS AND TUBES

Swivel female elbow Mod. G7523

Thread BSPP ISO-228

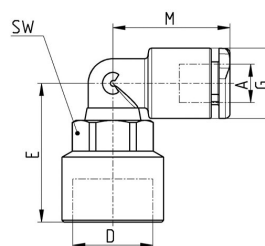

Mod.	A	D	E	G	M	SW	Weight (g)
G7523 4-1/8	4	G1/8	20	9,2	17	12	7
G7523 4-1/4	4	G1/4	21,5	9,2	17	12	10
G7523 6-1/8	6	G1/8	21	11,4	19	12	8
G7523 6-1/4	6	G1/4	21	11,4	19	12	11
G7523 8-1/8	8	G1/8	22,5	13,7	21,5	12	11
G7523 8-1/4	8	G1/4	24,5	13,7	21,5	15	13
G7523 8-3/8	8	G3/8	26	13,7	21,5	15	21

10

Swivel male elbow Mod. G7520

Thread BSPT ISO-7 (with pre-applied PTFE sealant)

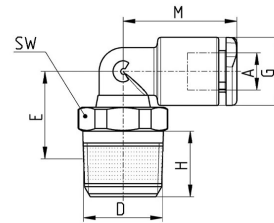

	A	D	E	G	H	M	SW	Weight (g)
G7520 4-1/8	4	R1/8	12,2	9,2	7,5	17	12	7
G7520 4-1/4	4	R1/4	14,5	9,2	11	17	14	10
G7520 6-1/8	6	R1/8	13,2	11,4	7,5	19	12	8
G7520 6-1/4	6	R1/4	15,5	11,4	11	19	14	11
G7520 6-3/8	6	R3/8	16,7	11,4	11,5	19	19	18
G7520 6-1/2	6	R1/2	18,5	11,4	14	19	22	20
G7520 8-1/8	8	R1/8	13,6	13,7	7,5	21,5	12	11
G7520 8-1/4	8	R1/4	14,2	13,7	11	21,5	14	13
G7520 8-3/8	8	R3/8	18,5	13,7	11,5	21,5	19	21

Swivel male elbow Mod. G7522

Thread metric parallel ISO-965 and BSPP ISO-228

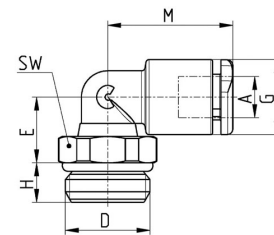

Mod.	A	D	E	G	H	M	SW	Weight (g)
G7522 4-M5	4	M5	8,2	9,2	3,5	17	9	4
G7522 4-M7	4	M7	11	9,2	5	17	10	6
G7522 4-1/8	4	G1/8	9	9,2	5	17	12	7
G7522 4-1/4	4	G1/4	9	9,2	6	17	14	10
G7522 6-M5	6	M5	9,2	11,4	3,5	19	9	5
G7522 6-M7	6	M7	12	11,4	5	19	10	7
G7522 6-M10x1	6	M10x1	12,2	11,4	5	19	12	8
G7522 6-M12x1,25	6	M12x1,25	10	11,4	6	19	14	11
G7522 6-1/8	6	G1/8	10	11,4	5	19	12	8
G7522 6-1/4	6	G1/4	10	11,4	6	19	14	11
G7522 6-3/8	6	G3/8	10	11,4	7	19	19	16
G7522 6-1/2	6	G1/2	10	11,4	8	19	24	15
G7522 8-M10x1	8	M10x1	13,5	13,7	5	21,5	12	11
G7522 8-M12x1,25	8	M12x1,25	12	13,7	6	21,5	14	14
G7522 8-1/8	8	G1/8	13,5	13,7	5	21,5	12	11
G7522 8-1/4	8	G1/4	12	13,7	6	21,5	14	14
G7522 8-3/8	8	G3/8	12	13,7	7	21,5	19	19

GRIPFIT PUSH-IN FITTINGS
SERIES 7000 - AUTOMATION - DIMENSIONS

Swivel male long elbow Mod. G7527

Thread BSPT ISO-7 (with pre-applied PTFE sealant)

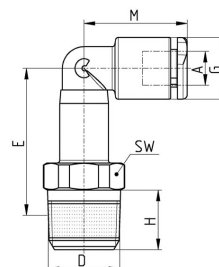

Mod.	A	D	E	G	H	M	SW	Weight (g)
G7527 4-1/8	4	R1/8	25,2	9,2	7,5	17	12	12
G7527 6-1/8	6	R1/8	26,2	11,4	7,5	19	12	13
G7527 6-1/4	6	R1/4	28	11,4	11	19	12	16
G7527 8-1/8	8	R1/8	32,4	13,7	7,5	21,5	12	18
G7527 8-1/4	8	R1/4	32,2	13,7	11	21,5	14	20

FITTINGS, CONNECTORS AND TUBES

Swivel male long elbow Mod. G7526

Thread metric parallel ISO-965 and BSPP ISO-228

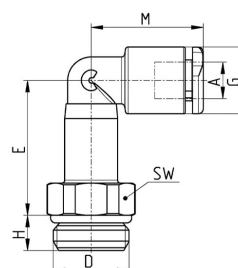

Mod.	A	D	E	G	H	M	SW	Weight (g)
G7526 4-M5	4	M5	24,6	9,2	3,5	17	10	9
G7526 4-1/8	4	G1/8	22	9,2	5	17	12	12
G7526 4-1/4	4	G1/4	22	9,2	6	17	14	14
G7526 6-M5	6	M5	25	11,4	5	19	10	10
G7526 6-M7*	6	M7	25	11,4	5	19	10	11
G7526 6-1/8	6	G1/8	23	11,4	5	19	12	13
G7526 6-1/4	6	G1/4	23	11,4	6	19	14	16
G7526 8-1/8	8	G1/8	29	13,7	5	21,5	12	18
G7526 8-1/4	8	G1/4	27	13,7	6	21,5	14	20

* Make to order

Swivel male central tee Mod. G7430

Thread BSPT ISO-7 (with pre-applied PTFE sealant)

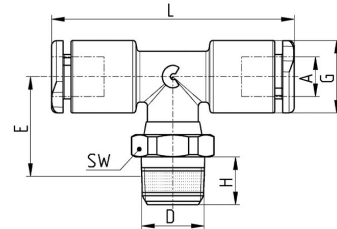

Mod.	A	D	E	G	H	L	SW	Weight (g)
G7430 4-1/8	4	R1/8	14,8	9,2	7,5	34	12	9
G7430 6-1/8	6	R1/8	16,3	11,4	7,5	38	12	11
G7430 6-1/4	6	R1/4	16,3	11,4	11	38	14	13
G7430 8-1/8	8	R1/8	19,1	13,7	7,5	43	12	15
G7430 8-1/4	8	R1/4	19,2	13,7	11	43	14	17

Swivel male central tee Mod. G7432

Thread metric parallel ISO-965 and BSPP ISO-228

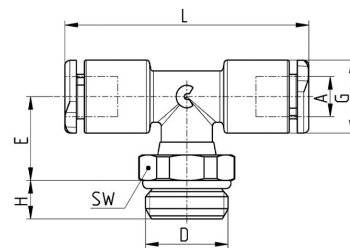

Mod.	A	D	E	G	H	L	SW	Weight (g)
G7432 4-M5	4	M5	14	9,2	3,5	34	9	7
G7432 4-1/8	4	G1/8	11,6	9,2	5	34	12	9
G7432 6-M5	6	M5	15,5	11,4	3,5	38	9	9
G7432 6-1/8	6	G1/8	13	11,4	5	38	12	11
G7432 6-1/4	6	G1/4	13	11,4	6	38	14	13
G7432 8-1/8	8	G1/8	16	13,7	5	43	12	15
G7432 8-1/4	8	G1/4	14,5	13,7	6	43	14	17
G7432 8-3/8	8	G3/8	15,5	13,7	7	43	19	25

GRIPFIT PUSH-IN FITTINGS
SERIES 7000 - AUTOMATION - DIMENSIONS

Swivel male lateral tee Mod. G7440

Thread BSPT ISO-7 (with pre-applied PTFE sealant)

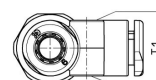
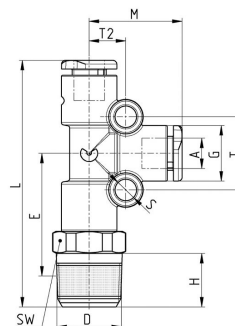

Mod.	A	D	E	G	H	L	M	S	T	T1	T2	SW	Weight (g)
G7440 4-1/8	4	R1/8	22,2	9,2	7,5	42,5	17	4	13	9,2	6,5	12	11
G7440 6-1/8	6	R1/8	23,7	11,4	7,5	46,5	19	4	15	11,4	7,5	12	15
G7440 6-1/4	6	R1/4	26	11,4	11	50,5	19	4	15	11,4	7,5	14	18
G7440 8-1/8	8	R1/8	26,2	13,7	7,5	49	21,5	4	17	13,7	8,5	14	23
G7440 8-1/4	8	R1/4	28	13,7	11	54,5	21,5	4	17	13,7	8,5	14	22

FITTINGS, CONNECTORS AND TUBES

Swivel male lateral tee Mod. G7442

Thread metric parallel ISO-965 and BSPP ISO-228

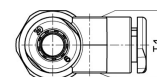
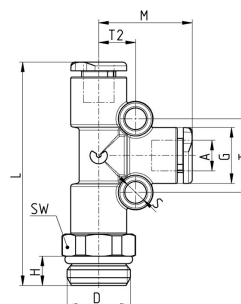

Mod.	A	D	G	H	L	M	S	T	T1	T2	SW	Weight (g)
G7442 4-M5	4	M5	9,2	3,5	39	17	4	13	9,2	6,5	10	9
G7442 4-1/8	4	G1/8	9,2	5	40,5	17	4	13	9,2	6,5	12	11
G7442 6-M5	6	M5	11,4	3,5	43	19	4	15	11,4	7,5	12	10
G7442 6-1/8	6	G1/8	11,4	5	44,5	19	4	15	11,4	7,5	12	15
G7442 6-1/4	6	G1/4	11,4	6	45,5	19	4	15	11,4	7,5	14	18
G7442 8-1/8	8	G1/8	13,7	5	50,5	21,5	4	17	13,7	8,5	14	23
G7442 8-1/4	8	G1/4	13,7	6	50,5	21,5	4	17	13,7	8,5	14	22
G7442 8-3/8	8	G3/8	13,7	7	52	21,5	4	17	13,7	8,5	19	28

10

Swivel male Y Mod. G7450

Swivel male Y
Thread BSPT ISO-7 (with pre-applied PTFE sealant)

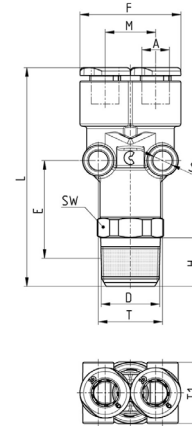

Mod.	A	D	E	F	H	L	M	S	T	T1	SW	Weight (g)
G7450 4-1/8	4	R1/8	19,7	18,5	7,5	42	9,2	4	12,2	11,6	12	13
G7450 6-1/8	6	R1/8	21,2	23	7,5	46	11,4	4	14,5	14	14	15
G7450 6-1/4	6	R1/4	23	23	11	49,5	11,4	4	14,5	14	14	29
G7450 8-1/8	8	R1/8	22,3	26	7,5	51,3	12,7	4	16,5	15,5	17	24
G7450 8-1/4	8	R1/4	24,1	26	11	54,8	12,7	4	16,5	15,5	17	30

Swivel male Y Mod. G7562

Thread BSPP ISO-228

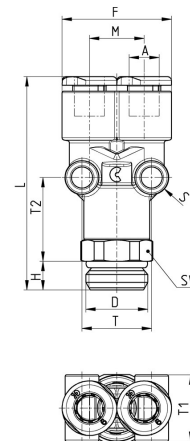

Mod.	A	D	F	H	L	M	S	T	T1	T2	SW	Weight (g)
G7562 4-1/8	4	G1/8	18,2	5	40,5	9,2	4	12,2	11,6	16,5	12	13
G7562 6-1/8	6	G1/8	23	5	44,5	11,4	4	14,5	14	18,5	14	15
G7562 6-1/4	6	G1/4	23	6	44,5	11,4	4	14,5	14	17,5	14	29
G7562 8-1/8	8	G1/8	26	5	48,5	12,7	4	16,5	15,5	20	14	24
G7562 8-1/4	8	G1/4	26	6	50	12,7	4	16,5	15,5	19,5	17	30

GRIPFIT PUSH-IN FITTINGS
SERIES 7000 - AUTOMATION - DIMENSIONS
Swivel male double Y Mod. G7572

Thread BSPP ISO-228

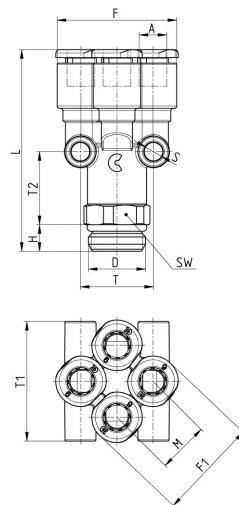

Mod.	A	D	F	F1	H	L	M	S	T	T1	T2	SW	Weight (g)
G7572 4-1/8	4	G1/8	22	18	5	40	9,3	4	14,5	22	15	12	17,5
G7572 4-1/4	4	G1/4	22	18	6	41	9,3	4	14,5	22	15	14	21,5
G7572 6-1/8	6	G1/8	27	22	5	45,5	11,5	4	16,5	27	17,5	14	17,5
G7572 6-1/4	6	G1/4	27	22	6	45,5	11,5	4	16,5	27	16,5	14	25,5

Swivel male single banjo Mod. G7622

Thread metric parallel ISO-965 and BSPP ISO-228

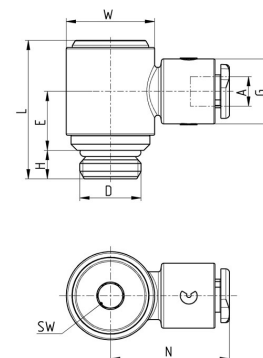

Mod.	A	D	E	G	H	L	N	W	SW	Weight (g)
G6622 4-M5*	4	M5	6	8,6	4	15,8	19	8,5	2,5	6
G7622 4-1/8	4	G1/8	10	11,4	5	24,5	21	14	4	12
G6622 6-M5*	6	M5	7	11,7	4	15,8	22,5	8,5	2,5	10
G7622 6-1/8	6	G1/8	10	11,4	5	24,5	21,5	14	4	12
G7622 6-1/4	6	G1/4	12,5	13,7	6	28	25	18,5	5	25
G7622 8-1/8	8	G1/8	10	13,7	5	24,5	23,5	14	4	14
G7622 8-1/4	8	G1/4	12,5	13,7	6	28	25,5	18,5	5	26

* Brass Body

Fittings Mod. G7652

Thread BSPP ISO-228

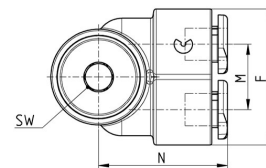
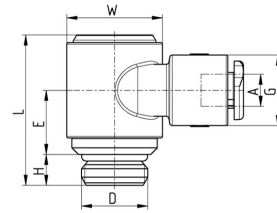

Mod.	A	D	E	F	G	H	L	M	N	W	SW	Weight (g)
G7652 4-1/8	4	G1/8	10	22,3	11,4	5	24,5	10,7	21	14	4	15
G7652 6-1/8	6	G1/8	10	22,3	11,4	5	24,5	10,7	21,5	14	4	15
G7652 6-1/4	6	G1/4	11,5	26,6	13,7	6	28	12,7	25	18	5	29
G7652 8-1/8	8	G1/8	10	26,6	13,7	5	24,5	12,7	23	14	4	18
G7652 8-1/4	8	G1/4	11,5	26,6	13,7	6	28	12,7	25,5	18	5	30

Male double single banjo adjustable Mod. G7612 02

Thread BSPP ISO-228

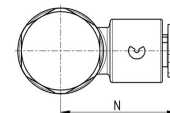
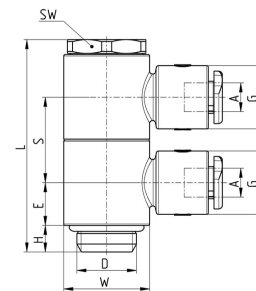

Mod.	A	D	E	G	H	L	N	S	W	SW	Weight (g)
G7612 02 4-1/8	4	G1/8	7,75	11,4	5	38,5	21	15,5	14	13	21
G7612 02 6-1/8	6	G1/8	7,75	11,4	5	38,5	21,5	15,5	14	13	21
G7612 02 6-1/4	6	G1/4	9,25	13,7	6	46	25	18,5	18,5	17	40
G7612 02 8-1/8	8	G1/8	7,75	13,7	5	38,5	23,5	15,5	14	13	24
G7612 02 8-1/4	8	G1/4	9,25	13,7	6	46	23,5	18,5	18,5	17	42

GRIPFIT PUSH-IN FITTINGS
SERIES 7000 - AUTOMATION - DIMENSIONS

Male triple single banjo adjustable Mod. G7612 03

Thread BSPP ISO-228

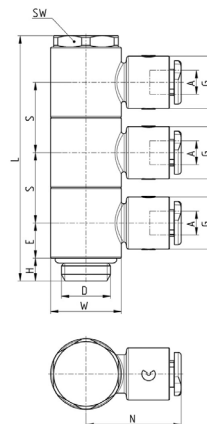

Mod.	A	D	E	G	H	L	N	S	W	SW	Weight (g)
G7612 03 4-1/8	4	G1/8	7,75	11,4	5	54	21	15,5	14	13	29
G7612 03 6-1/8	6	G1/8	7,75	11,4	5	54	21,5	15,5	14	13	30
G7612 03 6-1/4	6	G1/4	9,25	13,7	6	64,5	25	18,5	18,5	17	55
G7612 03 8-1/8	8	G1/8	7,75	13,7	5	54	23,5	15,5	14	13	34
G7612 03 8-1/4	8	G1/4	9,25	13,7	6	64,5	25,5	18,5	18,5	17	57

FITTINGS, CONNECTORS AND TUBES

Male double Y banjo adjustable Mod. G7642 02

Thread BSPP ISO-228

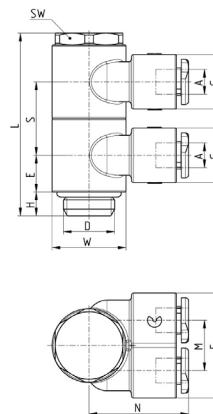

Mod.	A	D	E	F	G	H	L	M	N	S	W	SW	Weight (g)
G7642 02 4-1/8	4	G1/8	7,75	22,3	11,4	5	38,5	10,7	21	15,5	14	13	26
G7642 02 6-1/8	6	G1/8	7,75	22,3	11,4	5	38,5	10,7	21,5	15,5	14	13	28
G7642 02 6-1/4	6	G1/4	9,25	26,6	13,7	6	46	12,7	25	18,5	18,5	17	48
G7642 02 8-1/8	8	G1/8	7,75	26,6	13,7	5	38,5	12,7	23	15,5	14	13	33
G7642 02 8-1/4	8	G1/4	9,25	26,6	13,7	6	46	12,7	25,5	18,5	18,5	17	50

10

Male triple Y banjo adjustable Mod. G7642 03

Thread BSPP ISO-228

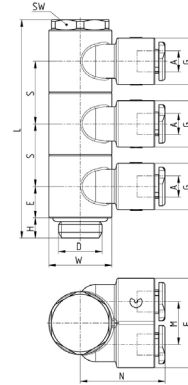

Mod.	A	D	E	F	G	H	L	M	N	S	W	SW	Weight (g)
G7642 03 4-1/8	4	G1/8	7,75	22,3	11,4	5	54	10,7	21	15,5	14	13	37
G7642 03 6-1/8	6	G1/8	7,75	22,3	11,4	5	54	10,7	21,5	15,5	14	13	39
G7642 03 6-1/4	6	G1/4	9,25	26,6	13,7	6	64,5	12,7	25	18,5	18,5	17	67
G7642 03 8-1/8	8	G1/8	7,75	26,6	13,7	5	54	12,7	23	15,5	14	13	47
G7642 03 8-1/4	8	G1/4	9,25	26,6	13,7	6	64,5	12,7	25,5	18,5	18,5	17	71

Single banjo body Mod. G7610

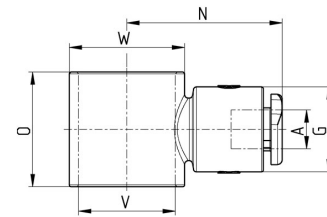
To be assembled with Mod. 7632 02*, Mod. 7632 03*.

Mod.	A	G	N	O	V	W	Weight (g)
G7610 4-1/8	4	11,4	21	15,5	11	14	6
G7610 6-1/8	6	11,4	21,5	15,5	11	14	7
G7610 6-1/4	6	13,7	25	18,5	15,5	18,5	9
G7610 8-1/8	8	13,7	23,5	15,5	11	14	10
G7610 8-1/4	8	13,7	25,5	18,5	18,5	18,5	10

GRIPFIT PUSH-IN FITTINGS
SERIES 7000 - AUTOMATION - DIMENSIONS

Double banjo body Mod. G7640

To be assembled with Mod. 7632 02*, Mod. 7632 03*.

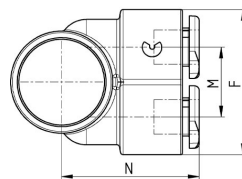
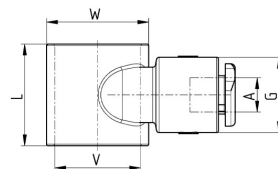

Mod.	A	F	G	L	M	N	V	W	Weight (g)
G7640 4-1/8	4	22,3	11,4	15,5	10,7	21	11	14	6
G7640 6-1/8	6	22,3	11,4	15,5	10,7	21,5	11	14	7
G7640 6-1/4	6	26,6	13,7	18,5	12,7	25	15,5	18,5	9
G7640 8-1/8	8	26,6	13,7	18,5	12,7	23	11	14	10
G7640 8-1/4	8	26,6	13,7	18,5	12,7	25,5	15,5	18,5	10

FITTINGS, CONNECTORS AND TUBES

Double stem for banjo body Mod. 7632 02*

To be assembled with Mod. G7610, Mod. G7640.

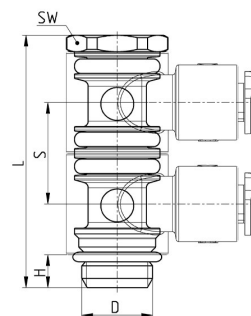

Mod.	D	H	L	S	SW	Weight (g)
7632 02-1/8	G1/8	5	38,5	15,5	13	13,5
7632 02-1/4	G1/4	6	46	18,5	17	29

10

GRIPFIT PUSH-IN FITTINGS
SERIES 7000 - AUTOMATION - DIMENSIONS
Triple stem for banjo body Mod. 7632 03*

To be assembled with Mod. G7610.,Mod. G7640.

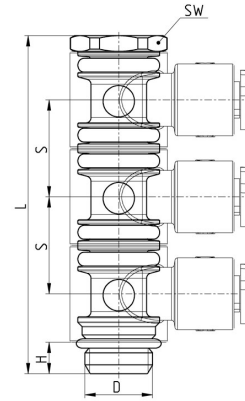

Mod.	D	H	L	S	SW	Weight (g)
7632 03-1/8	G1/8	5	54	15,5	13	17,5
7632 03-1/4	G1/4	6	64,5	18,5	17	38

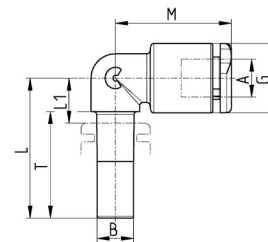
Equal and reducer junction elbow Mod. G7555

Mod.	A	B	G	L	L1	M	T	Weight (g)
G7555 4-4	4	4	9,2	21	7	17	16,5	2
G7555 4-6	4	6	9,2	23	8	17	18,5	3
G7555 6-4	6	4	11,4	22	7	19	16,5	3
G7555 6-6	6	6	11,4	23	8	19	17,5	4
G7555 6-8	6	8	11,4	24	9	19	18,5	4
G7555 8-6	8	6	13,7	24	8	21,5	17,5	4
G7555 8-8	8	8	13,7	25	9	21,5	18,5	5

GRIPFIT PUSH-IN FITTINGS
SERIES 7000 - AUTOMATION - DIMENSIONS

Center adaptor tee Mod. G7435

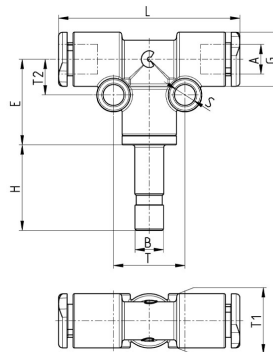

Mod.	A	B	E	G	H	L	S	T	T1	T2	Weight (g)
G7435 4-4	4	4	16,5	9,2	16,5	34	4	13	9,2	6,5	11
G7435 6-6	6	6	18	11,4	18	38	4	15	11,4	7,5	15
G7435 8-8	8	8	20	13,7	20,5	43	4	17	13,7	8,5	23

FITTINGS, CONNECTORS AND TUBES

Lateral adaptor tee Mod. G7445

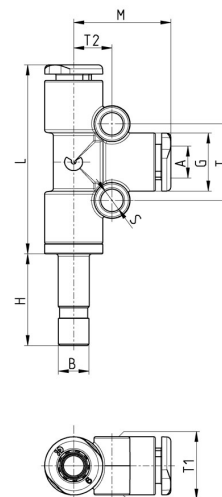

Mod.	A	B	G	H	L	M	S	T	T1	T2	Weight (g)
G7445 4-4	4	4	9,2	16,5	33	17	4	13	9,2	6,5	11
G7445 6-6	6	6	11,4	18	37	19	4	15	11,4	7,5	15
G7445 8-8	8	8	13,7	20,5	42	21,5	4	17	13,7	8,5	23

10

Central adaptor Y Mod. G7565

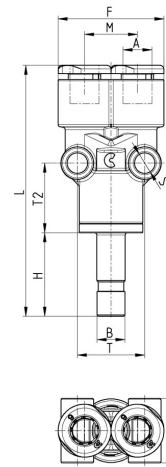

Mod.	A	B	F	H	L	M	S	T	T1	T2	Weight (g)
G7565 4-4	4	4	18,2	16,5	49,5	9	4	10,8	9,5	14	8
G7565 6-6	6	6	23	18	54	11,4	4	14,5	11,5	15	11
G7565 8-8	8	8	27,2	20,5	60,5	13,5	4	17	14	14	17

Reducer junction straight Mod. G7800

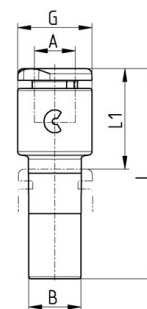

Mod.	A	B	G	L	L1	Weight (g)
G7800 4-6	4	6	9,3	29,5	14	2
G7800 4-8	4	8	9,3	30,5	14	3
G7800 6-8	6	8	11,4	32,5	15,5	4
G7800 6-10	6	10	11,4	34,5	15,5	4
G7800 6-12	6	12	11,4	36,2	15,5	4
G7800 8-10	8	10	13,7	36,2	17,2	5
G7800 8-12	8	12	13,7	37,9	17,2	6

GRIPFIT PUSH-IN FITTINGS
SERIES 7000 - AUTOMATION - DIMENSIONS
Bulkhead connector Mod. G6590

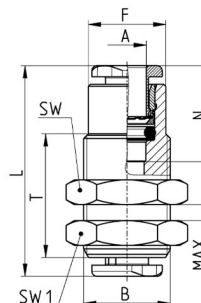
 Nickel-plated brass
 Thread metric parallel ISO-965

Mod.	A	B	F	L	MAX	N	T	SW	SW1	Weight [g]
G6590 4	4	M10x1	8,8	28	10,5	14,6	20	14	14	9,5
G6590 6	6	M14x1	12,5	31	10,5	15,5	20	17	17	21
G6590 8	8	M16x1	14,5	34,5	11,5	17,3	21	19	19	26

FITTINGS, CONNECTORS AND TUBES

Equal and reducer intermediate straight Mod. G7580

10

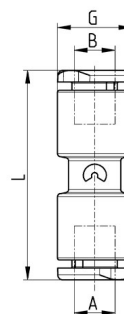

Mod.	A	B	G	L	Weight (g)
G7580 4	4	4	9,2	29,2	4
G7580 4-6	4	6	11,4	31,5	5
G7580 4-8	4	8	13,7	34,4	5
G7580 6	6	6	11,4	32	6
G7580 6-8	6	8	13,7	34,9	7
G7580 8	8	8	13,7	35,4	8

Equal and reducer intermediate elbow Mod. G7550

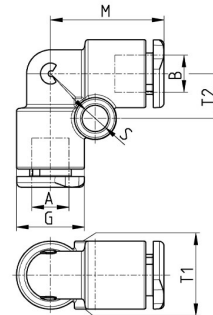

Mod.	A	B	G	M	S	T1	T2	Weight (g)
G7550 4	4	4	9,2	17	4	9,2	6,5	4
G7550 4-6	4	6	11,4	19	4	11,4	7,5	5
G7550 6	6	6	11,4	19	4	11,4	7,5	6
G7550 6-8	6	8	13,7	21,5	4	13,7	8,5	8
G7550 8	8	8	13,7	21,5	4	13,7	8,5	9

Equal and reducer intermediate tee Mod. G7540

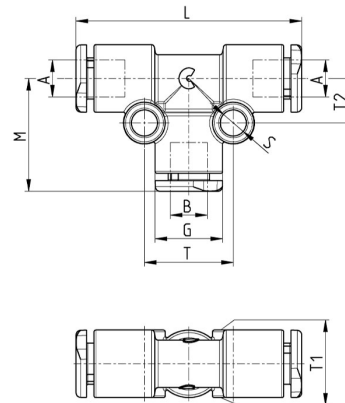

Mod.	A	B	G	L	M	S	T	T1	T2	Weight (g)
G7540 4	4	4	9,2	34	17	4	12	9,2	6,5	6
G7540 6	6	6	11,4	38	19	4	15	11,4	7,5	9
G7540 6-6-4	6	4	11,4	38	19	4	15	11,4	7,5	8
G7540 8	8	8	13,7	43	21,5	4	17	13,7	8,5	14
G7540 8-8-4	8	4	13,7	43	21,5	4	17	13,7	8,5	12
G7540 8-8-6	8	6	13,7	43	21,5	4	17	13,7	8,5	13

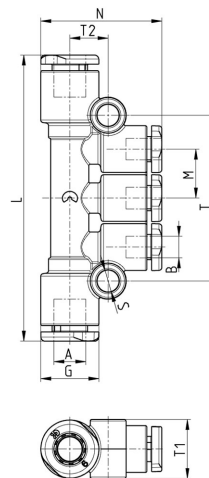
GRIPFIT PUSH-IN FITTINGS
SERIES 7000 - AUTOMATION - DIMENSIONS
Reducer intermediate multiple tee Mod. G7545

Mod.	A	B	G	L	M	N	S	T	T1	T2	Weight (g)
G7545 6-4	6	4	11,4	56	9,6	26,7	4	32,5	11,6	7,5	12
G7545 8-4	8	4	13,7	66	11,5	27	4	38,2	13,7	8	16
G7545 8-6	8	6	13,7	66	11,5	27	4	38,2	13,7	9	18

FITTINGS, CONNECTORS AND TUBES

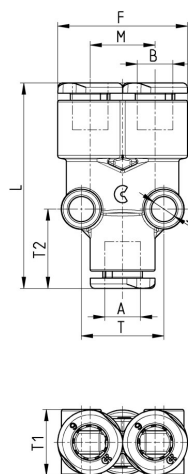
Equal and reducer intermediate Y Mod. G7560

Mod.	A	B	F	L	M	S	T	T1	T2	Weight (g)
G7560 4	4	4	18,2	33,2	9	4	10,8	9,5	13	6
G7560 6	6	6	23	36	11,4	4	14,5	11,5	14	9
G7560 6-4	6	4	18,2	34	9	4	12,2	11,5	15	8
G7560 8	8	8	27,2	41,5	13,5	4	17	14	15	15
G7560 8-6	8	6	23	37,5	11,4	4	14,5	11,5	16	13

10

Equal and reducer intermediate double Y Mod. G7575

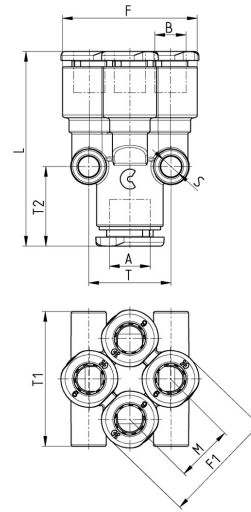

Mod.	A	B	F	F1	L	M	S	T	T1	T2	Weight (g)
G7575 4	4	4	22	18	33,1	9,3	4	14,5	22	13,5	12,5
G7575 6-4	6	4	22	18	33,6	9,3	4	14,5	22	13,5	14,5
G7575 6	6	6	27	22	38	11,5	4	16,5	27	15	17,5
G7575 8-6	8	6	27	22	38,5	11,5	4	16,5	27	15	19,5

Accessory Mod. 6900

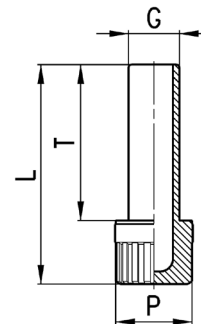

Mod.	G	L	P	T	Weight [g]
6900 4	4	29	8	20	1
6900 6	6	31,5	8	22,5	1
6900 8	8	34,5	12	24,5	2

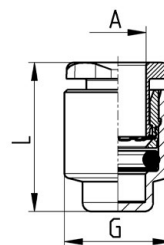
Female plug Mod. G6750

Mod.	A	G	L	Weight (g)
G6750 4	4	8,8	15,6	2,5
G6750 6	6	11,8	16,5	4,5
G6750 8	8	13,8	18,3	5,5

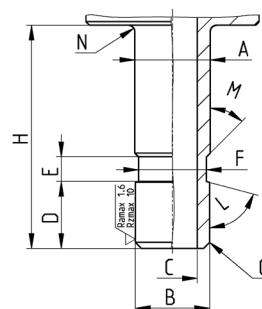
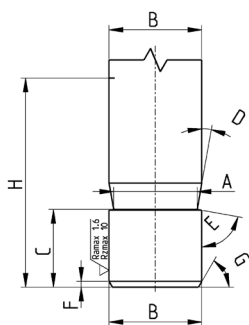
Groove for metal pipe

Made by Camozzi grooving tool 8TRT (or machining)

A	B	C	D	E	F	G	H
3,4	4	5,3	10°	80°	0,5	30°	16,5
5,2	6	6,25	10°	80°	0,5	30°	18
7,2	8	6,4	10°	80°	0,5	30°	20

Made by machining

A	B	C	D	E	F	G	H	L	M	N
4,1	4	2	5,3	2	3,5	0,5x45°	16,5	75°	45°	0,5
6,1	6	4	5,4	2	5,5	0,5x45°	18	75°	45°	0,5
8,1	8	6	6	2	7,5	0,5x45°	20,5	75°	45°	0,5

Grooving tool for metallic tubes

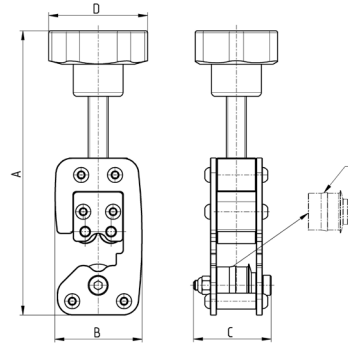

Mod.	Tube \varnothing	A (max)	B	C	D	Weight [g]	E (spare wheel)
8TRT 4	4	138	43,5	39	50	450	RTRT 4
8TRT 6	6	140	43,5	39	50	450	RTRT 6
8TRT 8	8	143	43,5	39	50	450	RTRT 8

Plastic junction Mod. 7950

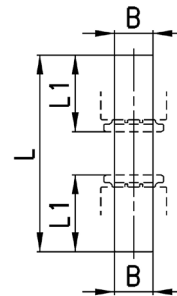

Mod.	B	L	L1	Weight [g]
7950 4	4	37	14	1
7950 6	6	39	15	1
7950 8	8	41	16	1
7950 10	10	44	18,5	1
7950 12	12	49	19	1