

CATALOGO



RACCORDI E ACCESSORI IN ACCIAIO INOX



BENVENUTI NEL MONDO CAMOZZI

Camozzi Automation è leader nella progettazione e produzione di componenti, sistemi e tecnologie per il controllo del movimento e dei fluidi per i settori dell'automazione industriale, dei trasporti e del Life Science



Contatti

Camozzi Automation S.p.A.
Società Unipersonale
Via Eritrea, 20/I
25126 Brescia
Italia
Tel. +39 030 37921
www.camozzi.com

Assistenza Clienti
Tel. +39 030 3792790
service@camozzi.com

Segreteria Commerciale
Tel. +39 030 3792255
commerciale@camozzi.com

Indice generale

1 Raccordi super-rapidi

Raccordi super-rapidi in Acciaio Inox 316L Serie X6000	6
--	---

2 Raccordi a calzamento

Raccordi a calzamento in Acciaio Inox 316L Serie X1000	11
--	----

3 Accessori in Acciaio Inox

Raccordi accessori in Acciaio Inox 316L Serie X2000	14
---	----

4 Regolatori di flusso, Raccordi a funzione e Silenziatori

Regolatori di flusso in Acciaio Inox 316L Serie XSCU, XSCO, XMFU e XMFO	20
Valvole di regolazione della portata in Acciaio Inox 316L Serie XRFU e XRFO	22
Valvole di scarico rapido in Acciaio Inox 316L Serie XVSC	24
Valvole unidirezionali in Acciaio Inox 316L Serie XVNR	25
Silenziatori in Acciaio Inox 316L	26

5 Valvole a sfera

Mini valvole a sfera in Acciaio Inox 316 Serie X29	27
--	----

RACCORDI E ACCESSORI IN ACCIAIO INOX SOLUZIONI PER FLUIDI AGGRESSIVI



Camozzi ha ampliato la famiglia della connessione pneumatica e fluidica con la nuova gamma di raccordi e accessori in acciaio inox 316L per le applicazioni industriali che richiedono soluzioni sicure e resistenti a elevate temperature di esercizio, corrosione e contaminazione.

L'offerta completa include raccordi accessori, a calzamento, a funzione pneumatica, regolatori di flusso, silenzianti e mini valvole, in molteplici figure e numerose taglie per soddisfare le diverse esigenze applicative.

Tutte le famiglie di prodotto garantiscono connessioni sicure e affidabili nelle differenti condizioni di lavoro.

La struttura totalmente in acciaio inox rende questa gamma ideale per settori come food & beverage, farmaceutico, chimico, sanitario e cosmetico, in cui sono richieste igienicità, affidabilità e inerzia chimica per evitare rotture e manutenzioni straordinarie dovute a fenomeni corrosivi.



Settori e Applicazioni:

- Alimentare
- Chimico
- Farmaceutico
- Life Science
- Taglio laser
- Verniciatura
- Gestione termica



VANTAGGI



**Elevata resistenza ai fluidi
e ambienti aggressivi**



**Certificazione NSF per applicazioni
nel settore alimentare**

Per maggiori informazioni consultare l'elenco dei prodotti e servizi certificati NSF



**Facilità di connessione
e disconnessione**



**Resistenza chimica
alla corrosione**



**Resistente
agli urti meccanici**

Raccordi super-rapidi in Acciaio Inox 316L Serie X6000



RACCORDI SUPER-RAPIDI SERIE X6000



I raccordi Serie X6000 impiegano il sistema di aggancio push-in che rende la connessione e la disconnessione del tubo semplice e rapida, pur mantenendo qualità e prestazioni elevate. Il corpo in acciaio inox garantisce il corretto funzionamento, anche in presenza di fluidi aggressivi.

CARATTERISTICHE GENERALI

Diametri	ø 4 - 6 - 8 - 10 - 12 mm	
Attacchi	GAS conico ISO 7 (BSPT) GAS cilindrico ISO 228 (BSPP)	
Temperatura	-15°C ÷ +150°C NB: per un utilizzo ottimale del raccordo è opportuno verificare le caratteristiche dei tubi impiegati	
Tubo di collegamento	PA6, PA11, PA12, Poliuretano (PU), Polietilene (PE), PTFE, FEP	
Fluido	aria compressa, fluidi alimentari, acqua potabile e tutti i fluidi compatibili con i materiali dei componenti dei raccordi	
Materiali	1 = Corpo	Acciaio INOX 316L
	2 = Guarnizioni	FKM Alimentare
	3 = Anello di sostegno	Acciaio INOX 316L
	4 = Pinza di aggancio	Acciaio INOX 301
	5 = Bussola di fermo	Acciaio INOX 316L
	6 = Bussola di sgancio	Acciaio INOX 316L
Pressione nominale	max 20 bar (verificare scheda tecnica del tubo impiegato)	

Raccordo con tubo di collegamento

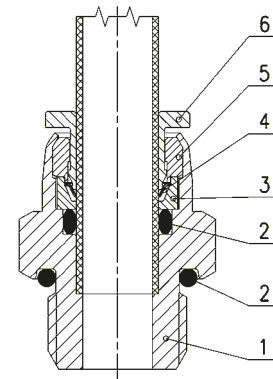

Raccordi Mod. X6510



Diritto Maschio Conico

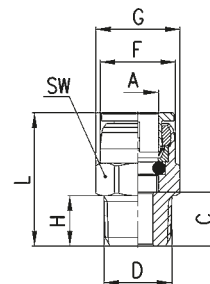

DIMENSIONI								
Mod.	A	D	C	F	G	H	L	SW
X6510 4-1/8	4	R1/8	8	9.7	-	8	20.5	10
X6510 4-1/4	4	R1/4	10	9.7	-	10	22.5	14
X6510 6-1/8	6	R1/8	8	11.6	13.4	8	21.5	12
X6510 6-1/4	6	R1/4	10	11.6	15.2	10	23.5	14
X6510 8-1/8	8	R1/8	8.5	14.7	17	8	24.6	15
X6510 8-1/4	8	R1/4	10	14.7	17	10	26.1	15
X6510 10-1/4	10	R1/4	11	17.4	20.8	10	28.2	19
X6510 10-3/8	10	R3/8	12	17.4	20.8	11	29.2	19
X6510 10-1/2	10	R1/2	14	17.4	24.6	13	31.2	22
X6510 12-1/4	12	R1/4	12	20	-	10	31	22
X6510 12-3/8	12	R3/8	12.5	20	-	11	31.5	22
X6510 12-1/2	12	R1/2	14.5	20	-	13	33.5	22

Raccordi Mod. X6512



Diritto Maschio Cilindrico

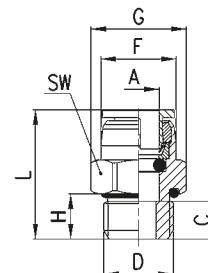

DIMENSIONI								
Mod.	A	D	C	F	G	H	L	SW
X6512 4-1/8	4	G1/8	5.7	9.7	-	5.7	18.2	14
X6512 4-1/4	4	G1/4	6.4	9.7	-	6	18.9	17
X6512 6-1/8	6	G1/8	6.7	11.6	15	5.7	20.2	14
X6512 6-1/4	6	G1/4	6.5	11.6	-	6	20	17
X6512 8-1/8	8	G1/8	8.7	14.7	-	5.7	24.8	15
X6512 8-1/4	8	G1/4	6	14.7	-	6	22.1	17
X6512 10-1/4	10	G1/4	8.5	17.4	-	6	25.7	19
X6512 10-3/8	10	G3/8	6.5	17.4	-	6.5	23.7	22
X6512 10-1/2	10	G1/2	11.5	17.4	30	9.5	28.7	27
X6512 12-1/4	12	G1/4	8.5	20	-	6	27.5	22
X6512 12-3/8	12	G3/8	9	20	-	6.5	28	22
X6512 12-1/2	12	G1/2	12.5	20	30	9.5	31.5	27

Raccordi Mod. X6500



Gomito Conico Fisso

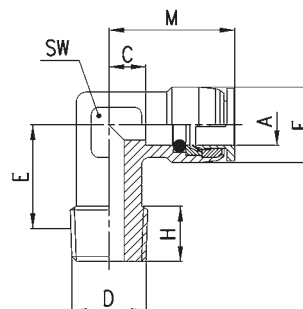

DIMENSIONI								
Mod.	A	D	C	E	F	H	M	SW
X6500 4-1/8	4	R1/8	7.8	12.5	11	8	20.3	12
X6500 6-1/8	6	R1/8	8.8	12.5	11.9	8	22.3	12
X6500 6-1/4	6	R1/4	8.8	12	11.9	9	22.3	12
X6500 8-1/8	8	R1/8	8.4	15	15	8	24.5	12
X6500 8-1/4	8	R1/4	8.4	14	15	10	24.5	12
X6500 10-1/4	10	R1/4	8.7	15	17.4	10	25.9	14
X6500 10-3/8	10	R3/8	8.7	15	17.4	10.8	25.9	14
X6500 12-1/4	12	R1/4	9.5	16	20	10	28.5	17
X6500 12-3/8	12	R3/8	9.5	16	20	12	28.5	17

Raccordi Mod. X6520

Gomito Conico Girevole

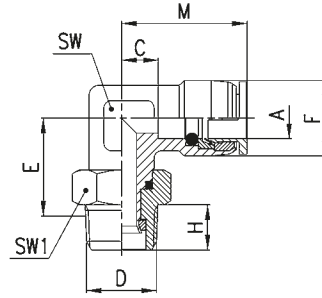

DIMENSIONI									
Mod.	A	D	C	E	F	H	M	SW	SW1
X6520 4-1/8	4	R1/8	4.3	15.3	10	8	16.8	12	12
X6520 4-1/4	4	R1/4	4.3	15.8	10	10	16.8	12	15
X6520 6-1/8	6	R1/8	8.8	15.3	11.9	8	22.3	12	12
X6520 6-1/4	6	R1/4	5.8	19.8	13	10	19.3	14	15
X6520 8-1/8	8	R1/8	9.4	19.5	15	8	25.5	14	12
X6520 8-1/4	8	R1/4	9.4	19.8	15	10	25.5	14	15
X6520 10-1/4	10	R1/4	10.7	20.6	17.4	10	27.9	17	15
X6520 10-3/8	10	R3/8	10.7	20.9	17.4	11	27.9	17	19
X6520 12-1/4	12	R1/4	9.5	21.1	20	10	28.5	17	15
X6520 12-3/8	12	R3/8	9.5	20.9	20	11	28.5	17	19
X6520 12-1/2	12	R1/2	9.5	19.4	20	13	28.5	17	22

Raccordi Mod. X6430

T Conico Centrale Girevole

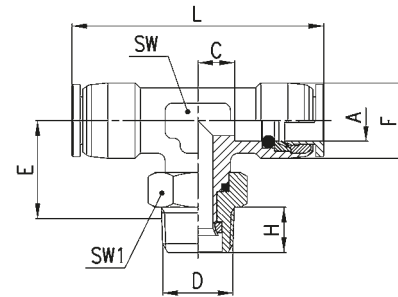

DIMENSIONI									
Mod.	A	D	C	E	F	H	L	SW	SW1
X6430 4-1/8	4	R1/8	4.3	15.3	10	8	33.6	12	12
X6430 4-1/4	4	R1/4	4.3	15.8	10	10	33.6	12	15
X6430 6-1/8	6	R1/8	8.8	16.1	11.9	8	44.6	12	12
X6430 6-1/4	6	R1/4	5.8	18.6	13	10	38.6	14	15
X6430 8-1/8	8	R1/8	8.3	17.3	15	8	48.8	14	12
X6430 8-1/4	8	R1/4	8.3	18.5	15	10	48.8	14	15
X6430 10-1/4	10	R1/4	10.7	21.1	17.4	10	55.8	17	15
X6430 10-3/8	10	R3/8	10.7	20.9	17.4	11	55.8	17	19
X6430 12-1/4	12	R1/4	9.5	21.1	20	10	57	17	15
X6430 12-3/8	12	R3/8	9.5	20.9	20	11	57	17	19
X6430 12-1/2	12	R1/2	15.6	19.4	20	13	57	17	22

Raccordi Mod. X6522

Gomito Cilindrico Girevole

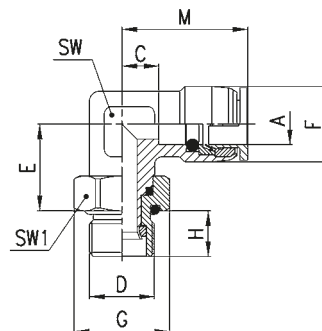

DIMENSIONI										
Mod.	A	D	C	E	F	G	H	M	SW	SW1
X6522 4-1/8	4	G1/8	4.3	15.3	10	15	6.5	16.8	12	14
X6522 4-1/4	4	G1/4	4.3	15.7	10	18.5	9	16.8	12	17
X6522 6-1/8	6	G1/8	8.8	15.3	11.9	15	6.5	22.3	12	14
X6522 6-1/4	6	G1/4	5.8	18.7	13	18.5	9	19.3	14	17
X6522 8-1/8	8	G1/8	9.4	19.5	15	15	6.5	25.5	14	14
X6522 8-1/4	8	G1/4	9.4	18.7	15	18.5	9	25.5	14	17
X6522 10-1/4	10	G1/4	10.7	19.5	17.4	18.5	9	27.9	17	17
X6522 10-3/8	10	G3/8	10.7	20.4	17.4	24	9	27.9	17	22
X6522 12-1/4	12	G1/4	9.5	20	20	18.5	9	28.5	17	17
X6522 12-3/8	12	G3/8	9.5	20.4	20	24	9	28.5	17	22
X6522 12-1/2	12	G1/2	9.5	20.4	20	30	9.5	28.5	17	27

Raccordi Mod. X6432

T Cilindrico Centrale Girevole

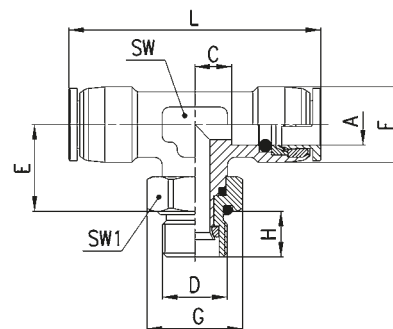

DIMENSIONI										
Mod.	A	D	C	E	F	G	H	L	SW	SW1
X6432 4-1/8	4	G1/8	4.3	15.3	10	15	6.5	33.6	12	14
X6432 4-1/4	4	G1/4	4.3	15.7	10	18.5	9	33.6	12	17
X6432 6-1/8	6	G1/8	8.8	16.1	11.9	15	6.5	44.6	12	14
X6432 6-1/4	6	G1/4	5.8	17.5	13	18.5	9	38.6	14	17
X6432 8-1/8	8	G1/8	8.3	17.3	15	15	6.5	48.8	14	14
X6432 8-1/4	8	G1/4	8.3	17.4	15	18.5	9	48.8	14	17
X6432 10-1/4	10	G1/4	10.7	20	17.4	18.5	9	55.8	17	17
X6432 10-3/8	10	G3/8	10.7	20.4	17.4	24	9	55.8	17	22
X6432 12-1/4	12	G1/4	9.5	20	20	18.5	9	57	17	17
X6432 12-3/8	12	G3/8	9.5	20.4	20	24	9	57	17	22
X6432 12-1/2	12	G1/2	9.5	20.4	20	30	9.5	57	17	27

Raccordi Mod. X6580

Diritto Intermedio

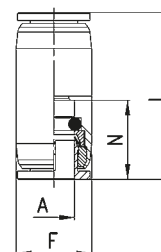

DIMENSIONI				
Mod.	A	F	L	N
X6580 4	4	10	26.5	12.5
X6580 6	6	12	28.4	13.5
X6580 8	8	15	33.7	16.1
X6580 10	10	18	36.4	17.2
X6580 12	12	20	41	19

Raccordi Mod. X6550

Gomito Intermedio

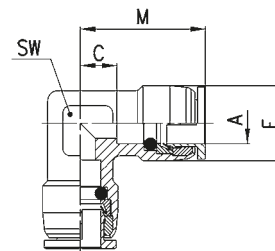

DIMENSIONI					
Mod.	A	C	F	M	SW
X6550 4	4	7.8	11	20.3	12
X6550 6	6	8.8	11.9	22.3	12
X6550 8	8	8.4	15	24.5	12
X6550 10	10	8.7	17.4	25.9	14
X6550 12	12	9.5	20	28.5	17

Raccordi Mod. X6540

T Intermedio

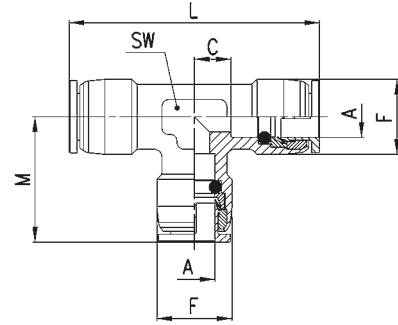

DIMENSIONI						
Mod.	A	C	F	L	M	SW
X6540 4	4	8.8	11	42.6	21.3	12
X6540 6	6	8.8	11.9	44.6	22.3	12
X6540 8	8	8.4	15	49	24.5	12
X6540 10	10	8.7	17.4	51.8	25.9	14
X6540 12	12	9.5	20	57	28.5	17

Raccordi Mod. X6590

Diritto Intermedio Passaparete

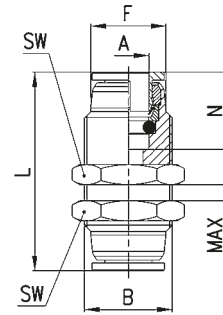

DIMENSIONI							
Mod.	A	B	F	L	N	MAX	SW
X6590 4	4	M11X1	9.7	29	12.5	6	14
X6590 6	6	M13X1	11.6	34	13.5	9	17
X6590 8	8	M16X1	14.7	37.2	16.1	9	19
X6590 10	10	M19X1	17.4	43.4	17.2	11	22
X6590 12	12	M22X1	20	50	19	15	27

Raccordi Mod. X6800

Riduzione Tubo-Codolo

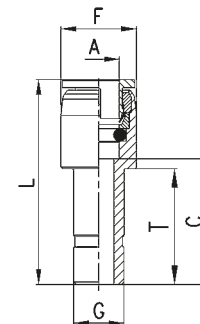

DIMENSIONI						
Mod.	A	C	F	G	L	T
X6800 4-6	4	16.8	10	6	29.3	15.3
X6800 4-8	4	19.8	10	8	32.3	17.8
X6800 6-8	6	19.8	12	8	33.5	17.8
X6800 6-10	6	22.6	12	10	36	21.6
X6800 6-12	6	23	12	12	36.5	-
X6800 8-10	8	22.5	15	10	38.6	20
X6800 8-12	8	24.5	15	12	40.6	23
X6800 10-12	10	26	18	12	43.2	23

Raccordi a calzamento in Acciaio Inox 316L

Serie X1000



I raccordi rapidi Serie X1000 a calzamento sono di facile installazione. I dadi di serraggio del calzamento si possono stringere con le mani oppure con l'ausilio di una chiave anche con tubi rigidi come il PA e il Poliesteri Hytrel. La particolare forma del cono di conduzione evita possibili tagli del tubo.

CARATTERISTICHE GENERALI

Diametri	6/4 - 8/6 - 10/8 - 12/10
Attacchi	GAS conico ISO 7 (BSPT)
Temperatura	-40°C ÷ +180°C NB: per un utilizzo ottimale del raccordo è opportuno verificare le caratteristiche dei tubi impiegati
Tubo di collegamento	Poliammide (PA), Poliuretano (PU), Polietilene (PE), PTFE, FEP, Poliesteri Hytrel
Fluido	tutti i fluidi compatibili con i materiali dei componenti dei raccordi
Materiali	corpo in acciaio inox 316L dado in acciaio inox 316L
Pressione d'esercizio	la pressione nominale dei raccordi è sempre superiore alla pressione di utilizzo del tubo

Raccordo con tubo di collegamento

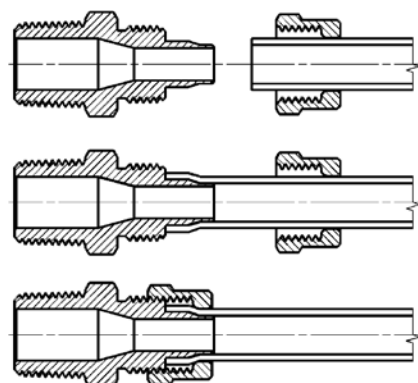

Raccordi Mod. X1510



Diritto Maschio Conico



DIMENSIONI								
Mod.	tubo	D	H	H1	H2	L	SW	SW1
X1510 6/4-1/8	6/4	R1/8	8	8	15	27	12	12
X1510 6/4-1/4	6/4	R1/4	10	8	15	31	14	12
X1510 8/6-1/8	8/6	R1/8	8	8	16	28	14	14
X1510 8/6-1/4	8/6	R1/4	10	8	16	32	14	14
X1510 8/6-3/8	8/6	R3/8	10	8	16	32	17	14
X1510 10/8-1/4	10/8	R1/4	10,5	9	17	33	14	17
X1510 10/8-3/8	10/8	R3/8	11	9	17	33	17	17
X1510 10/8-1/2	10/8	R1/2	14	9	17	37	22	17
X1510 12/10-1/4	12/10	R1/4	10	9	18	34	17	17
X1510 12/10-3/8	12/10	R3/8	10	9	18	34	17	19
X1510 12/10-1/2	12/10	R1/2	13	9	18	38	22	19

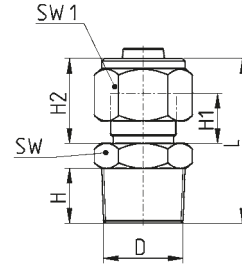

Raccordi Mod. X1500



Gomito Maschio Fisso Conico



DIMENSIONI								
Mod.	tubo	D	E	H	H1	M	SW	SW1
X1500 6/4-1/8	6/4	R1/8	15,5	7,5	15	21	8	12
X1500 6/4-1/4	6/4	R1/4	19,5	7,5	15	21	8	12
X1500 8/6-1/8	8/6	R1/8	17	7,5	16	22,5	10	14
X1500 8/6-1/4	8/6	R1/4	20	12	15	24	11	14
X1500 8/6-3/8	8/6	R3/8	24,5	12	19,5	28	14	14
X1500 10/8-1/4	10/8	R1/4	21,5	10	17,5	25,5	12	17
X1500 10/8-3/8	10/8	R3/8	23	12	18	28	14	17
X1500 10/8-1/2	10/8	R1/2	28	15	21	30	17	17
X1500 12/10-3/8	12/10	R3/8	22	12	18	28	14	19
X1500 12/10-1/2	12/10	R1/2	26	15	21	30	17	19

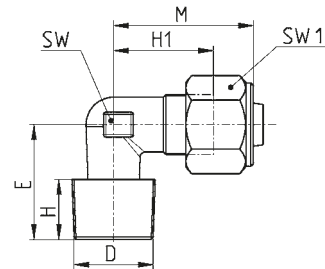

Raccordi Mod. X1580



Diritto Intermedio



DIMENSIONI						
Mod.	tubo	H	L	M	SW	SW1
X1580 6/4	6/4	8	35	15	12	12
X1580 8/6	8/6	8	37	16	12	14
X1580 10/8	10/8	9	40	17	14	17
X1580 12/10	12/10	9	43	19	17	19

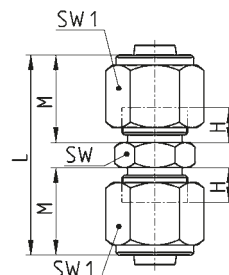

Raccordi Mod. X1590

Diritto Passaparete

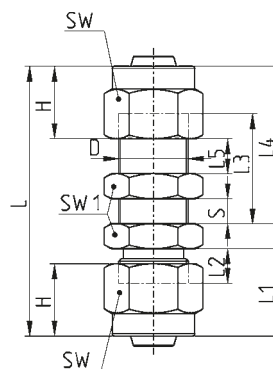

DIMENSIONI												
Mod.	tubo	D	H	L	L1	L2	L3	L4	L5	S (max)	SW	SW1
X1590 6/4	6/4	M10x1	11,4	47	15	8	20	27	5	13	12	14
X1590 8/6	8/6	M12x1	12,7	50	16	8	21	29	5	13	14	17
X1590 10/8	10/8	M14x1	14,5	54	17,5	9	23	31,5	5	14	17	17
X1590 12/10	12/10	M16x1	14,5	57	18	9	25	34	5	14	19	19

Raccordi Mod. X1550

Gomito Intermedio

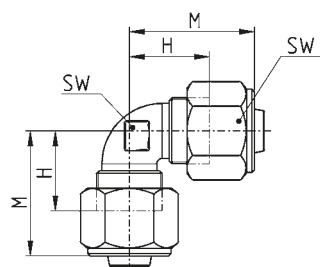

DIMENSIONI					
Mod.	tubo	H	M	SW	SW1
X1550 6/4	6/4	15	21	8	12
X1550 8/6	8/6	16,5	22,5	10	14
X1550 10/8	10/8	18	25,5	12	17
X1550 12/10	12/10	19	29	14	19

Raccordi Mod. X1540

T Intermedio

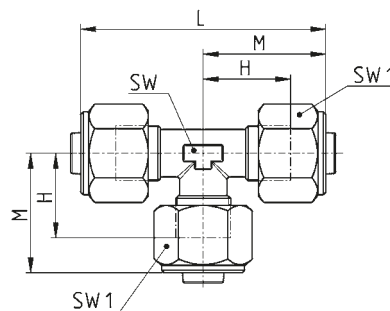

DIMENSIONI						
Mod.	tubo	H	L	M	SW	SW1
X1540 6/4	6/4	14,5	42	21	8	12
X1540 8/6	8/6	16,5	45	22,5	10	14
X1540 10/8	10/8	18	51	25	12	17
X1540 12/10	12/10	19,6	58	28,8	14	19

Accessori Mod. X1703

Dado di bloccaggio

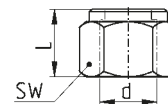

DIMENSIONI				
Mod.	tubo	d	L	SW
X1703 6/4	6/4	10x1	11,4	12
X1703 8/6	8/6	12x1	11,7	14
X1703 10/8	10/8	14x1	13,5	17
X1703 12/10	12/10	16x1	14,5	19

Raccordi accessori in Acciaio Inox 316L Serie X2000



I raccordi accessori Serie X2000 in acciaio inossidabile AISI 316L sono disponibili in diverse configurazioni per soddisfare le richieste del cliente in termini di affidabilità e adattabilità.

Possono essere utilizzati all'interno di impianti pneumatici, oleodinamici (a bassa pressione), idropneumatici e trovano impiego in diversi settori tra cui quello alimentare, quello chimico e quello medicale.

CARATTERISTICHE GENERALI

Attacchi	GAS conico ISO 7 (BSPT) GAS cilindrico ISO 228 (BSPP) NPT
Temperatura	-50°C ÷ +250°C -15°C ÷ +180°C (X2612 - X2612 EH)
Fluido	tutti i fluidi compatibili con il materiale dei componenti dei raccordi
Materiali	acciaio inox 316L
Pressione d'esercizio	-0.9 / 120 bar

Raccordi accessori

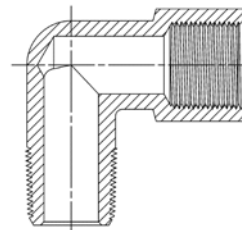

Raccordi Mod. X2500



Niplo Conico



DIMENSIONI						
Mod.	D	D1	H	H1	L	SW
X2500 1/8	R1/8	R1/8	8	8	20	12
X2500 1/4	R1/4	R1/4	11	11	27	14
X2500 3/8	R3/8	R3/8	11	11	28	17
X2500 1/2	R1/2	R1/2	14	14	33	22
X2500 3/4	R3/4	R3/4	16	16	40	27
X2500 1/8PT	1/8NPT	1/8NPT	9	9	23	11
X2500 1/4PT	1/4NPT	1/4NPT	12	12	29	14
X2500 3/8PT	3/8NPT	3/8NPT	13	13	33	19
X2500 1/2PT	1/2NPT	1/2NPT	17	17	42	22
X2500 1/8-1/8PT	R1/8	1/8NPT	8	9	21	11
X2500 1/4-1/4PT	R1/4	1/4NPT	11	12	28	14
X2500 3/8-3/8PT	R3/8	3/8NPT	11	13	30	19
X2500 1/2-1/2PT	R1/2	1/2NPT	14	17	37	22
X2500 3/4-3/4PT	R3/4	3/4NPT	16	16	40	27

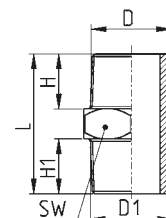

Raccordi Mod. X2510

Nipplo Ridotto Conico

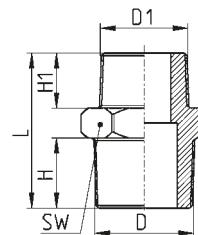

DIMENSIONI						
Mod.	D	D1	H	H1	L	SW
X2510 1/8-1/4	R1/8	R1/4	8	11	23	14
X2510 1/8-3/8	R1/8	R3/8	8	11	24	17
X2510 1/4-3/8	R1/4	R3/8	11	11	28	17
X2510 1/4-1/2	R1/4	R1/2	11	14	30	22
X2510 3/8-1/2	R3/8	R1/2	11	14	31	22
X2510 1/2-3/4	R1/2	R3/4	14	16	38	27
X2510 1/8PT-1/4PT	1/8NPT	1/4NPT	9	13	28	14
X2510 1/8PT-3/8PT	1/8NPT	3/8NPT	9	13	29	19
X2510 1/4PT-3/8PT	1/4NPT	3/8NPT	13	13	33	19
X2510 1/4PT-1/2PT	1/4NPT	1/2NPT	13	17	38	22
X2510 3/8PT-1/2PT	3/8NPT	1/2NPT	13	17	38	22

Raccordi Mod. X2520

Prolunga Riduzione Maschio Conica

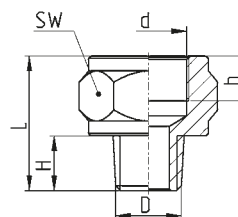

DIMENSIONI						
Mod.	D	d	H	h (min)	L	SW
X2520 1/8-1/4	R1/8	G1/4	9	12	24	19
X2520 1/8-3/8	R1/8	G3/8	9	12	25	24
X2520 1/4-3/8	R1/4	G3/8	11	12	27	24
X2520 1/4-1/2	R1/4	G1/2	11	14	29	27
X2520 3/8-1/2	R3/8	G1/2	12	14	30	27
X2520 1/2-3/4	R1/2	G3/4	13	12	32	32

Raccordi Mod. X2530

Riduttore BSPT a NPT Adattatore BSPT a NPT Adattatore NPT a BSPP

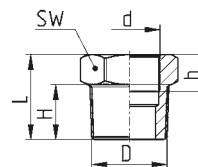

DIMENSIONI						
Mod.	D	d	H	h (min)	L	SW
X2530 1/8-M5	R1/8	M5x0,8	7	8	12	12
X2530 1/4-1/8	R1/4	G1/8	10	7	16	14
X2530 3/8-1/8	R3/8	G1/8	11	8	17	17
X2530 3/8-1/4	R3/8	G1/4	11	10	17	17
X2530 1/2-1/4	R1/2	G1/4	14	10	19	22
X2530 1/2-3/8	R1/2	G3/8	14	11	19	22
X2530 3/4-1/2	R3/4	G1/2	17	14	23	27
X2530 1/4PT-1/8PT	1/4NPT	1/8NPT	11	7	16	14
X2530 3/8PT-1/8PT	3/8NPT	1/8NPT	11	7	17	19
X2530 3/8PT-1/4PT	3/8NPT	1/4NPT	11	12	17	19
X2530 1/2PT-1/4PT	1/2NPT	1/4NPT	14	12	20	22
X2530 1/2PT-3/8PT	1/2NPT	3/8NPT	14	13	20	22
X2530 1/8PT-1/8	R1/8	1/8NPT	11	8	21	14
X2530 1/4PT-1/4	R1/4	1/4NPT	15	11,5	28,5	17
X2530 3/8PT-3/8	R3/8	3/8NPT	16	12	29,5	22
X2530 1/2PT-1/2	R1/2	1/2NPT	20	15,5	37,5	27
X2530 1/8-1/8PT	1/8NPT	G1/8	11	7,5	21,5	14
X2530 1/4-1/4PT	1/4NPT	G1/4	14,5	11	30	17
X2530 3/8-3/8PT	3/8NPT	G3/8	16,5	11,5	31	22
X2530 1/2-1/2PT	1/2NPT	G1/2	21	15	39,5	27

Raccordi Mod. X2543

Manicotto Cilindrico e NPT



DIMENSIONI			
Mod.	d	L	SW
X2543 1/8	G1/8	17	14
X2543 1/4	G1/4	24	17
X2543 3/8	G3/8	25	22
X2543 1/2	G1/2	32	27
X2543 3/4	G3/4	35	32
X2543 1/8PT-1/8PT	1/8NPT	19	14
X2543 1/4PT-1/4PT	1/4NPT	28	17
X2543 3/8PT-3/8PT	3/8NPT	28	22
X2543 1/2PT-1/2PT	1/2NPT	35	27

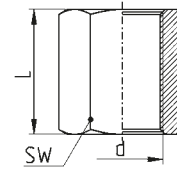

Raccordi Mod. X2593

Diritto Passaparete Cilindrico e NPT



DIMENSIONI							
Mod.	d	D	h (max)	H	L	SW	SW1
X2593 1/8	G1/8	M16x1,5	9	14	18	19	22
X2593 1/4	G1/4	M20x1,5	15	21	25	24	27
X2593 3/8	G3/8	M26x1,5	14	21	26	30	32
X2593 1/2	G1/2	M28x1,5	20	27	33	32	36
X2593 3/4	G3/4	M34x1,5	22,5	30	36	41	41
X2593 1	G1	M42x1,5	24,5	34	42	46	50
X2593 1/8PT-1/8PT	1/8NPT	M16x1,5	9	14	18	19	22
X2593 1/4PT-1/4PT	1/4NPT	M20x1,5	15	23	28	24	27
X2593 3/8PT-3/8PT	3/8NPT	M26x1,5	14	21	26	30	32
X2593 1/2PT-1/2PT	1/2NPT	M28x1,5	20	27	33	32	36

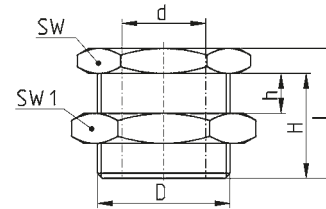

Raccordi Mod. X2600

Portagomma Maschio Conico



DIMENSIONI							
Mod.	D	N	d	H	H1	L	SW
X2600 6-1/8	R1/8	6	3,3	7,5	19,5	32	11
X2600 7-1/8	R1/8	7	4,6	7,5	19	32	11
X2600 7-1/4	R1/4	7	4,6	11	20	36	14
X2600 8-1/4	R1/4	8	6	11	19,5	36	14
X2600 9-1/4	R1/4	9	6,3	11	19	35	14
X2600 9-3/8	R3/8	9	6,3	11,5	19	36	17
X2600 10-1/4	R1/4	10	7,4	11	19	36	14
X2600 10-3/8	R3/8	10	7,4	11,5	19	36	17
X2600 10-1/2	R1/2	10	7,4	13,5	19,5	39	22
X2600 12-1/4	R1/4	12	8	11	20	36	14
X2600 12-3/8	R3/8	12	9,5	11	19,5	36	17
X2600 12-1/2	R1/2	12	9,5	14	19,5	39	22
X2600 14-3/8	R3/8	14	10,5	11	19	35	17
X2600 14-1/2	R1/2	14	10,5	14	19,5	39	22
X2600 16-3/8	R3/8	16	12	11	29	40	17
X2600 16-1/2	R1/2	16	12	13,5	19,5	39	22
X2600 18-1/2	R1/2	18	14	13,5	19,5	39	22
X2600 18-3/4	R3/4	18	14	15,5	19,5	43	27
X2600 20-1/2	R1/2	20	15	14	19	39	22
X2600 20-3/4	R3/4	20	15	16	20	43	27
X2600 25-3/4	R3/4	25	19,9	16	20	43	27

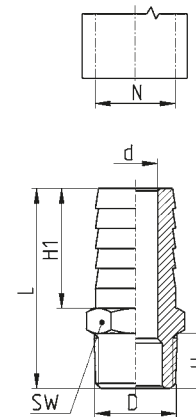

Raccordi Mod. X2612 EH



Tappo Maschio Cilindrico
esagono esterno, o-ring in FKM

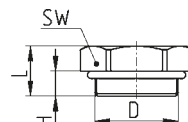

DIMENSIONI				
Mod.	D	H	L	SW
X2612 1/8-EH	G1/8	5	9	13
X2612 1/4-EH	G1/4	5	9	16
X2612 3/8-EH	G3/8	5	10	20
X2612 1/2-EH	G1/2	7	12	24

Raccordi Mod. X2612



Tappo Maschio Cilindrico
esagono incassato, o-ring in FKM

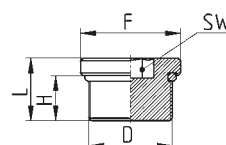

DIMENSIONI					
Mod.	D	F	H	L	SW
X2612 1/8	G1/8	14	6	8,5	5
X2612 1/4	G1/4	18	8	11,1	6
X2612 3/8	G3/8	20	9	12,5	8
X2612 1/2	G1/2	25	10	13,5	10

Raccordi Mod. X2615



Tappo Maschio a scomparsa Conico

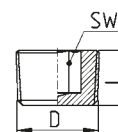

DIMENSIONI			
Mod.	D	L	SW
X2615 1/8	R1/8	7	5
X2615 1/4	R1/4	10	6
X2615 3/8	R3/8	11	8
X2615 1/2	R1/2	13	10

Raccordi Mod. X2013



Gomito Femmina Cilindrico

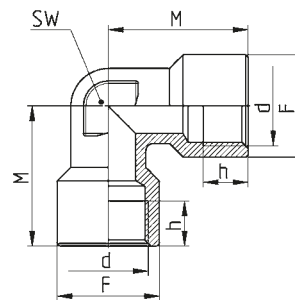

DIMENSIONI					
Mod.	d	h (min)	M	F	SW
X2013 1/8	G1/8	8	21	13	10
X2013 1/4	G1/4	11	25	16	12
X2013 3/8	G3/8	12	28	20	15
X2013 1/2	G1/2	15	32	25	20

Raccordi Mod. X2003



T Femmina Cilindrico

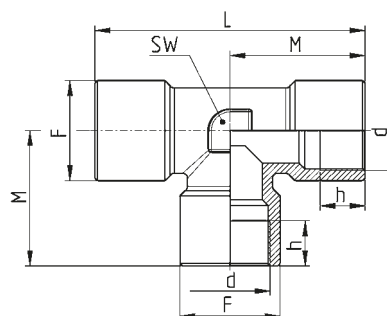

DIMENSIONI						
Mod.	d	F	h (min)	L	M	SW
X2003 1/8	G1/8	13	9	36	18	12
X2003 1/4	G1/4	16	11	48	24	12
X2003 3/8	G3/8	20	12	54	27	15
X2003 1/2	G1/2	25	15,5	64	32	20

Raccordi Mod. X2020

Gomito Maschio Conico Femmina Cilindrico

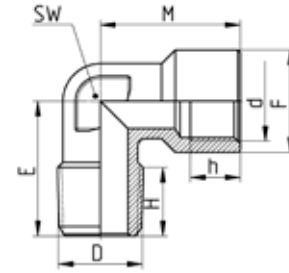

DIMENSIONI

Mod.	d	D	h (min)	H	M	E	F	SW
X2020 1/8-1/8	G1/8	R1/8	8	8	21	18	13	10
X2020 1/4-1/4	G1/4	R1/4	9	11	25.5	24	16.5	12
X2020 3/8-3/8	G3/8	R3/8	12	11	28	27	20	15
X2020 1/2-1/2	G1/2	R1/2	12	14.3	32	29.5	25.5	20

Raccordi Mod. X2060

T.F.M.F.

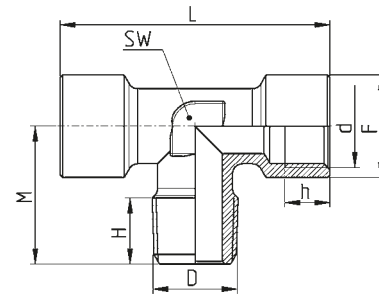

DIMENSIONI

Mod.	d	D	F	H	h (min)	L	M	SW
X2060 1/8-1/8	G1/8	R1/8	13	7.5	7	37	18	12
X2060 1/4-1/4	G1/4	R1/4	16	11	11	49	24	12
X2060 3/8-3/8	G3/8	R3/8	20	12	12	54	27	15
X2060 1/2-1/2	G1/2	R1/2	25	14	15	64	29	20

Raccordi Mod. X2070

T.F.M.F.F.

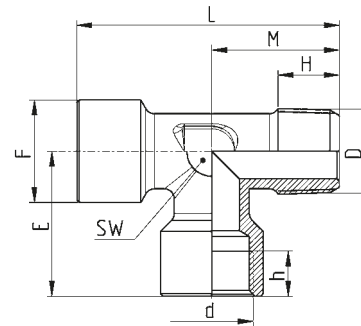

DIMENSIONI

Mod.	d	D	E	F	h (min)	H	L	M	SW
X2070 1/8-1/8	G1/8	R1/8	19	13	8	8	36	17	12
X2070 1/4-1/4	G1/4	R1/4	25	16	11	11	48	23	12
X2070 3/8-3/8	G3/8	R3/8	27	20	12	12	53	26	15
X2070 1/2-1/2	G1/2	R1/2	32	25	15	14	62	30	20

Accessori Mod. X3033

Blocchetto 4 Vie con fori di fissaggio

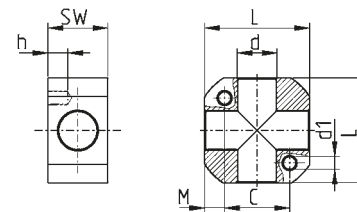

DIMENSIONI

Mod.	d	d1	C	h	L	M	SW
X3033 1/8	G1/8	M5	18	10	31	6,5	15
X3033 1/4	G1/4	M6	22	12	35	6,5	18
X3033 3/8	G3/8	M6	26	8	42	8	24
X3033 1/2	G1/2	M8	33	12	52	9,5	26

Regolatori di flusso in Acciaio Inox 316L

Serie XSCU, XSCO, XMFU e XMFO



Questi regolatori di flusso unidirezionali e bidirezionali sono stati realizzati per essere montati direttamente su valvole o cilindri in ambienti con presenza di fluidi o gas aggressivi.

CARATTERISTICHE GENERALI

Costruzione	a spillo
Gruppo valvola	regolatore unidirezionale e bidirezionale
Materiali	corpo e vite di regolazione: acciaio inox 316L guarnizioni: FKM
Fissaggio	a mezzo filetto maschio/femmina
Attacchi	G1/8, G1/4, G3/8, G1/2
Installazione	in qualsiasi posizione
Temperatura d'esercizio	-10°C ÷ +120°C
Pressione d'esercizio	1 ÷ 10 bar (regolatore unidirezionale) 0 ÷ 10 bar (regolatore bidirezionale Serie XMFO) 0 ÷ 8 bar (regolatore bidirezionale Serie XSCO)
Pressione nominale	6 bar
Diametro nominale	XSCU, XSCO: G1/8 = 4,5 - G1/4 = 6 - G3/8 = 8 - G1/2 = 12 XMFU, XMFO: G1/8 = 7,2 - G1/4 = 7,2 - G3/8 = 12 - G1/2 = 12
Fluido	aria filtrata senza lubrificazione con regolatori di flusso unidirezionali e bidirezionali tutti i fluidi compatibili con i materiali dei componenti dei regolatori di flusso bidirezionali

ESEMPIO DI CODIFICA

X	M	CU	-	M5
X	= INOX			
M	AZIONAMENTO: M = manuale S = cacciavite			
CU	MONTAGGIO: CU = su cilindro unidirezionale CO = bidirezionale FU = unidirezionale FO = bidirezionale			
M5	ATTACCHI: 1/8 = G1/8 1/4 = G1/4 3/8 = G3/8 1/2 = G1/2			

Per una corretta scelta del regolatore di flusso unidirezionale, si consiglia di procedere nel seguente modo: calcolare la quantità d'aria in NL/1' (vedere tabella cilindri), stabilire in quanto tempo il cilindro deve fare la sua corsa, quindi controllare il diagramma per stabilire quale dei due regolatori è quello idoneo.

Regolatori di flusso unidirezionali Serie XSCU

Regolazione a cacciavite

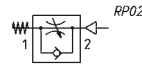

DIMENSIONI													
Mod.	D	d	F	F1	H	L	L1	M	S	S1	Z	SW	SW1
XSCU 1/8	G1/8	G1/8	16	15	6	38	36	17	8.5	8	43	16	13
XSCU 1/4	G1/4	G1/4	16	17	8	45	42	22.5	9.5	9.5	48	19	13
XSCU 3/8	G3/8	G3/8	22	22	13	67	63	25	11	13	72	26	20
XSCU 1/2	G1/2	G1/2	22	27	13	73	68	30	12	14	77	30	20

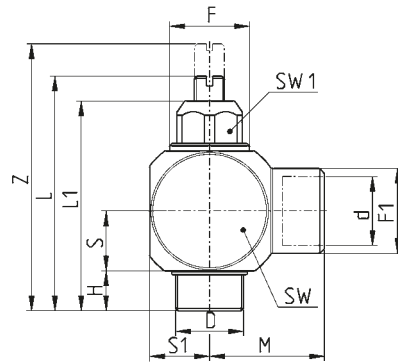

Regolatori di flusso bidirezionali Serie XSCO

Regolazione a cacciavite

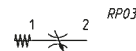

DIMENSIONI													
Mod.	D	d	F	F1	H	L	L1	M	S	S1	Z	SW	SW1
XSCO 1/8	G1/8	G1/8	15	15	6	38	36	17	8	8	43	16	13
XSCO 1/4	G1/4	G1/4	17	17	8	45	42	23	9	9	48	19	13
XSCO 3/8	G3/8	G3/8	24	22	13	63	63	25	11	13	72	26	20
XSCO 1/2	G1/2	G1/2	27	27	13	68	68	30	14	14	77	30	20

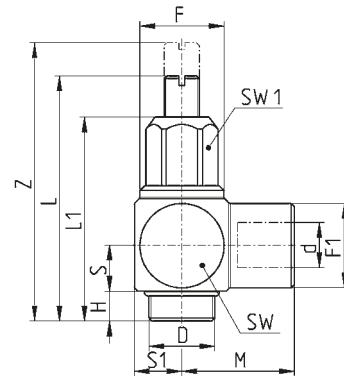

Regolatori di flusso unidirezionali Serie XMFU

Regolazione manuale

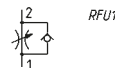

DIMENSIONI									
Mod.	d	D	H	L	L1	S	Z	SW	SW1
XMFU 1/8	G1/8	M15x0,75	35	77	43	22	82	22	19
XMFU 1/4	G1/4	M15x0,75	35	77	43	22	82	22	19
XMFU 3/8	G3/8	M25x1,5	54	111	65	36	125	36	32
XMFU 1/2	G1/2	M25x1,5	54	111	66	36	125	36	32

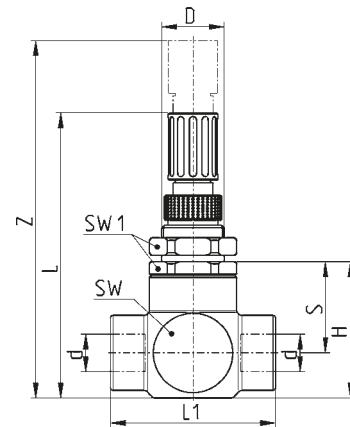

Regolatori di flusso bidirezionali Serie XMFO

Regolazione manuale

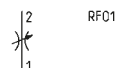

DIMENSIONI									
Mod.	d	D	H	L	L1	S	Z	SW	SW1
XMFO 1/8	G1/8	M15x0,75	35	77	42	21	82	22	20
XMFO 1/4	G1/4	M15x0,75	35	77	42	21	82	22	20
XMFO 3/8	G3/8	M25x1,5	54	111	66	36	125	36	32
XMFO 1/2	G1/2	M25x1,5	54	111	66	36	125	36	32

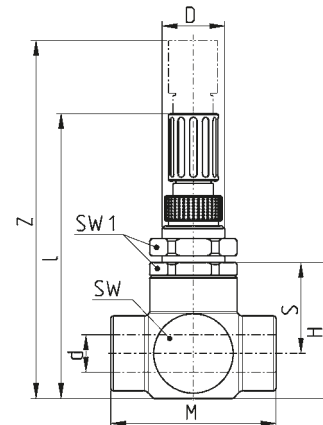

Valvole di regolazione della portata in Acciaio Inox 316L Serie XRFU e XRFO



- » Serie XRFU: valvole unidirezionali per la regolazione della velocità dei cilindri
- » Serie XRFO: valvole bidirezionali per la regolazione del flusso d'aria dei fluidi compatibili con i materiali dei componenti

I regolatori di flusso unidirezionali e bidirezionali sono stati realizzati con attacchi da G1/8, G1/4, G3/8 e G1/2. Tutti i modelli possono essere utilizzati in ambienti con presenza di fluidi o gas aggressivi.

CARATTERISTICHE GENERALI

Costruzione	a spillo
Gruppo valvola	regolatore unidirezionale o bidirezionale
Materiali	corpo in acciaio inox 316L, guarnizioni FKM
Fissaggio	a mezzo viti nei fori passanti nel corpo o a pannello
Attacchi filettati	G1/8, G1/4, G3/8, G1/2 1/8 NPT, 1/4 NPT, 3/8 NPT, 1/2 NPT
Installazione	in qualsiasi posizione
Temperatura d'esercizio	-15 ÷ +120°C
Pressione d'esercizio	- 0,5 ÷ + 16 bar (regolatore unidirezionale) 0 ÷ 40 bar (regolatore bidirezionale)
Pressione nominale	6 bar
Diametro nominale	G1/8 = 6 - G1/4 = 6 - G3/8 = 9 - G1/2 = 10 - PT1/8 = 6 - PT1/4 = 6 - PT3/8 = 9 - PT1/2 = 10
Fluido	aria filtrata senza lubrificazione con valvole di regolazione unidirezionali e bidirezionali tutti i fluidi compatibili con i materiali dei componenti delle valvole di regolazione bidirezionali

ESEMPIO DI CODIFICA

X	RF	U	-	1/8	PT
X	= INOX				
RF	SERIE				
U	FUNZIONE: U = unidirezionale O = bidirezionale				
1/8	ATTACCHI: 1/8 1/4 3/8 1/2				
PT	ATTACCHI: = gas PT = NPT				

Valvole unidirezionali Serie XRFU

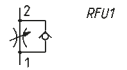
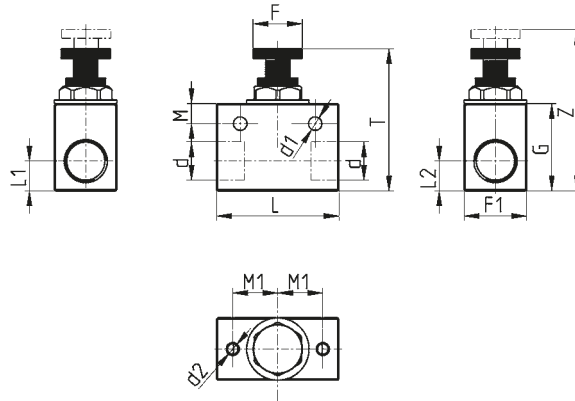

DIMENSIONI													
Mod.	d	d1	d2	F	F1	G	L	L1	L2	M	M1	T	Z
XRFU 1/8	G1/8	5,4	M5	20	20	30	40	6,5	13,5	8	15	49	54
XRFU 1/4	G1/4	5,4	M5	20	20	30	40	8	12	8	15	49	54
XRFU 3/8	G3/8	5,4	M5	20	25	35	49	10,5	15,5	8	18	57	66
XRFU 1/2	G1/2	5,4	M5	20	25	35	49	12,5	13	8	18	57	66
XRFU 1/8PT	1/8NPT	5,4	M5	20	20	30	40	6,5	13,5	8	15	49	54
XRFU 1/4PT	1/4NPT	5,4	M5	20	20	30	40	8	12	8	15	49	54
XRFU 3/8PT	3/8NPT	5,4	M5	20	25	35	49	10,5	15,5	8	18	57	66
XRFU 1/2PT	1/2NPT	5,4	M5	20	25	35	49	12,5	13	8	18	57	66

Valvole bidirezionali Serie XRF0

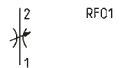
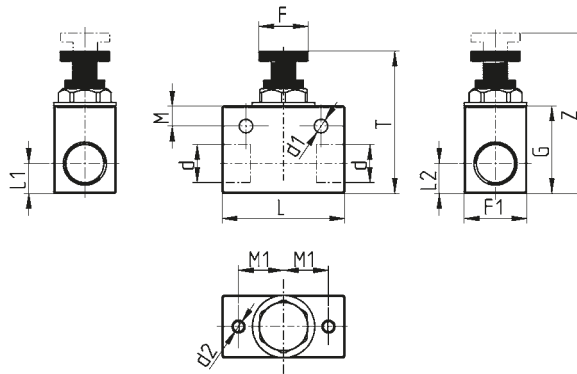

DIMENSIONI													
Mod.	d	d1	d2	F	F1	G	L	L1	L2	M	M1	T	Z
XRF0 1/8	G1/8	5,4	M5	20	20	30	40	6,5	13,5	8	15	49	54
XRF0 1/4	G1/4	5,4	M5	20	20	30	40	8	12	8	15	49	54
XRF0 3/8	G3/8	5,4	M5	20	25	35	49	10,5	15,5	8	18	57	66
XRF0 1/2	G1/2	5,4	M5	20	25	35	49	12,6	13	8	18	57	66
XRF0 1/8PT	1/8NPT	5,4	M5	20	20	30	40	6,5	13,5	8	15	49	54
XRF0 1/4PT	1/4NPT	5,4	M5	20	20	30	40	8	12	8	15	49	54
XRF0 3/8PT	3/8NPT	5,4	M5	20	25	35	49	10,5	15,5	8	18	57	66
XRF0 1/2PT	1/2NPT	5,4	M5	20	25	35	49	12,6	13	8	18	57	66

Valvole di scarico rapido in Acciaio Inox 316L Serie XVSC



- » Adatte per scaricare velocemente l'aria contenuta in serbatoi, impianti o camere dei cilindri
- » Versioni filettate

Le valvole di scarico rapido Serie XVSC sono comunemente impiegate per aumentare la velocità dei cilindri o per depressurizzare velocemente serbatoi contenenti aria compressa in ambienti con presenza di fluidi o gas aggressivi.

CARATTERISTICHE GENERALI

Gruppo valvola	valvole automatiche
Costruzione	ad otturatore
Materiali	in acciaio inox 316L guarnizioni FKM 1/8 1/4 guarnizioni poliuretano 3/8 1/2
Fissaggio	in qualsiasi posizione
Attacchi	G1/8, G1/4, G1/2, G3/8 1/8 NPT, 1/4 NPT, 3/8 NPT, 1/2 NPT
Temperatura d'esercizio	1/8 1/4 GAS/NPT -10°C ÷ +120°C 3/8 1/2 GAS/NPT -20°C ÷ +80°C
Fluido	aria filtrata senza lubrificazione

Valvole di scarico rapido Serie XVSC

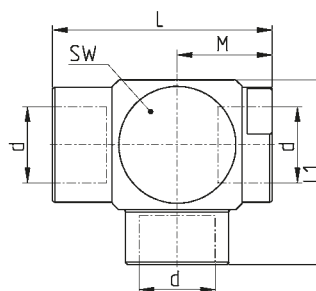
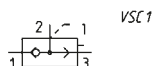

DIMENSIONI					
Mod.	d	M	L	L1	SW
XVSC 1/8	G1/8	16	37	32	22
XVSC 1/4	G1/4	16.5	37.5	31.5	22
XVSC 3/8	G3/8	19	44	37	26
XVSC 1/2	G1/2	31	54	45	32
XVSC 1/8PT	1/8NPT	16	37	32	22
XVSC 1/4PT	1/4NPT	16	37	32	22
XVSC 3/8PT	3/8NPT	19	44	37	26
XVSC 1/2PT	1/2NPT	31	54	45	32

Valvole unidirezionali in Acciaio Inox 316L Serie XVNR

VALVOLE UNIDIREZIONALI SERIE XVNR



- » Montaggio in linea
- » Basse pressioni di azionamento
- » Design robusto
- » Ampio range di compatibilità chimica e temperature di utilizzo più elevate

Le valvole unidirezionali Serie XVNR sono ideali per operare in applicazioni a bassa pressione in ambienti con presenza di fluidi o gas aggressivi.

CARATTERISTICHE GENERALI

Gruppo valvola	valvole automatiche
Costruzione	ad otturatore
Materiali	corpo in acciaio inox 316L molla in acciaio inox 316L guarnizioni FKM
Fissaggio	in qualsiasi posizione
Dimensioni filetto	G1/8, G1/4, G3/8, G1/2 1/8 NPT, 1/4 NPT, 3/8 NPT, 1/2 NPT
Temperatura d'esercizio	-20 ÷ +180 °C
Pressione d'esercizio	0,5 ÷ 40 bar
Pressione di apertura	0,25 bar
Fluido	aria filtrata senza lubrificazione, aria compressa e tutti i fluidi compatibili con i materiali dei componenti delle valvole unidirezionali

Valvole unidirezionali Serie XVNR



VNR1
1 2

DIMENSIONI				
Mod.	d	L	F	SW
XVNR 1/8	G1/8	50	22	17
XVNR 1/4	G1/4	50	22	17
XVNR 3/8	G3/8	67	30	22
XVNR 1/2	G1/2	71	30	24
XVNR 1/8PT	1/8NPT	50	22	17
XVNR 1/4PT	1/4NPT	54	22	17
XVNR 3/8PT	3/8NPT	67	30	22
XVNR 1/2PT	1/2NPT	77	30	24

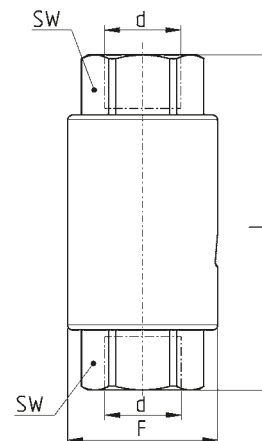

Silenziatori in Acciaio Inox 316L



I silenziatori sono elementi indispensabili per eliminare o attenuare il caratteristico rumore dell'aria compressa durante le fasi di scarico. Il loro collegamento in atmosfera naturale è sempre situato sugli scarichi delle valvole a 3/2, 5/2 o 5/3 vie. In fase di manutenzione si consiglia di sgrassare i silenziatori con benzina o petrolio avendo cura di soffiare con aria compressa nel senso opposto all' utilizzazione.

Portata: viene misurata a 6 bar d'ingresso e scarico in atmosfera.
Rumorosità: la prova per il rilevamento della rumorosità viene eseguita posizionando il fonometro a un metro dalla fonte del rumore ed alla stessa altezza. Il livello medio del rumore viene rilevato per un tempo di dieci secondi.

CARATTERISTICHE GENERALI

Tipo costruttivo	corpo con filetto maschio
Materiale	acciaio inox 316L
Attacchi	G1/8, G1/4, G3/8, G1/2, G3/4, G1 1/8NPT, 1/4NPT, 3/8NPT, 1/2NPT, 3/4NPT, 1NPT

Silenziatori Mod. X2901



SIL1



DIMENSIONI							
Mod.	D	H	L	SW	Max press. di utilizzo (bar)	Portata (NL/min)	Rumorosità db (A)
X2901 1/8	G1/8	8	15	14	10	700	76
X2901 1/4	G1/4	8	14	17	10	1000	78
X2901 3/8	G3/8	10	18	22	10	1500	76
X2901 1/2	G1/2	12	22	27	10	3400	86
X2901 3/4	G3/4	15	27	32	6	4100	87
X2901 1	G1	18	34	41	6	7600	88
X2901 1/8PT	1/8 NPT	7	14	14	10	700	76
X2901 1/4PT	1/4 NPT	11	17	17	10	1000	78
X2901 3/8PT	3/8 NPT	11	19	22	10	1500	76
X2901 1/2PT	1/2 NPT	15	25	27	10	3400	86
X2901 3/4PT	3/4 NPT	16	28	32	6	4100	87
X2901 1PT	1 NPT	19	35	41	6	7600	88

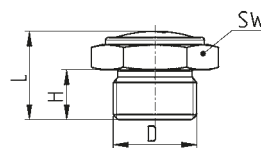

Mini valvole a sfera in Acciaio Inox 316 Serie X29

MINI VALVOLE A SFERA SERIE X29

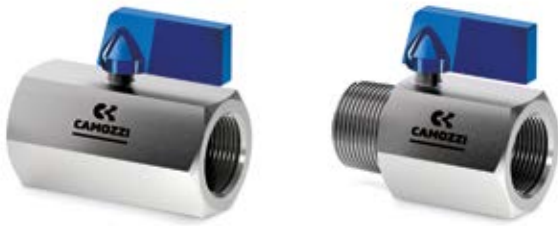

- » Dimensioni compatte
- » Massima portata
- » Leva facile da azionare

Le mini valvole a sfera gestiscono l'apertura o la chiusura di aria o di fluidi in applicazioni industriali caratterizzate da spazi estremamente ridotti e ambienti con presenza di fluidi o gas aggressivi.

Le dimensioni miniaturizzate e il peso contenuto della Serie X29 permettono un'installazione facile in qualsiasi punto dell'impianto, anche grazie all'attacco filettato.

CARATTERISTICHE GENERALI

Funzione	2/2 vie
Azionamento	rotazione leva di 90°
Attacchi	G1/4, G3/8, G1/2, R1/4, R3/8, R1/2
Diametro orifizio	da 7 mm a 9.2 mm
Pressione d'esercizio	0 ÷ 10 bar
Temperatura d'esercizio	-15 °C ÷ 80 °C
Materiali	corpo, stelo, sfera: acciaio inox 316; guarnizioni a sfera: PTFE; anello di tenuta stelo: FKM; Leva: alluminio
Fluido	aria compressa, gas inerti, acqua, olio e tutti i fluidi compatibili con i materiali dei componenti delle mini valvole a sfera

Mini valvole a sfera, versione MINI - Mod. X2943

2/2 in linea, filettature BSPP femmina-femmina

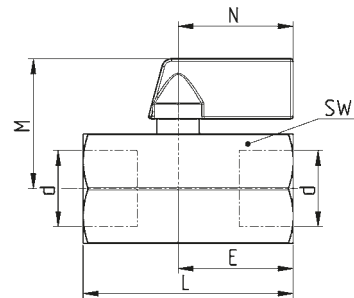
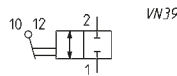

DIMENSIONI							
Mod.	d	DN	E	L	M	N	SW
X2943 1/4	G1/4	7	23	42	26	23	22
X2943 3/8	G3/8	7	23	42	26	23	22
X2943 1/2	G1/2	9,2	23	46	28	23	25

Mini valvole a sfera, versione MINI - Mod. X2944

2/2 in linea, filettatura maschio BSPT-Femmina BSPP

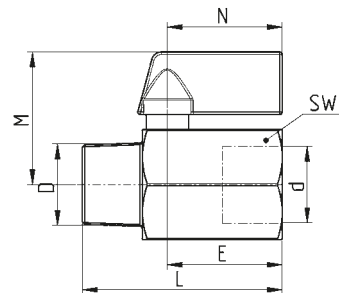
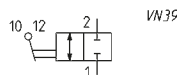

DIMENSIONI								
Mod.	d	D	DN	E	L	M	N	SW
X2944 1/4-1/4	G1/4	R1/4	7	23	40	26,5	23	22
X2944 3/8-3/8	G3/8	R3/8	7	23	40	26,5	23	22
X2944 1/2-1/2	G1/2	R1/2	9,2	23	45,6	28,3	23	25

SCOPRI LA GAMMA COMPLETA DI RACCORDI, VALVOLE, TUBI E ACCESSORI DI CAMOZZI AUTOMATION

Serie di raccordi:

Raccordi super-rapidi

- **Serie 6000**
Raccordi super-rapidi in ottone per tubi plastici
- **Serie 7000**
Raccordi super-rapidi Compact in tecnopolimero
- **Serie 7000 Fluidics**
Raccordi in tecnopolimero per raffreddamento ad acqua
- **Serie 8000**
Raccordi super-rapidi a doppia tenuta in ottone nichelato
- **Serie H8000**
Raccordi super-rapidi a doppia tenuta in ottone nichelato con colletto di protezione

Raccordi rapidi

- **Serie 1000**
Raccordi a calzamento in ottone per tubi plastici

Raccordi universali

- **Serie 1000**
Raccordi universali ad ogiva in ottone

Raccordi accessori

- **Serie S2000**
Raccordi accessori Sprint® in ottone
- **Serie 2000**
Raccordi accessori in ottone

Giunti ad innesto rapido

- **Serie 5000**
Giunti ad innesto rapido
- **Serie 5000L, 5000LT**
Giunti ad innesto rapido per il condizionamento di stampi per plastica

Tubi, spirali e accessori

- **Serie T, MPL, PNZ**
Tubi, spirali e accessori

Raccordi e accessori per applicazioni di gas medicali

- **Serie OX1**
Raccordi e accessori per applicazioni di gas medicali

Mini valvole a sfera

- **Serie 29**
Mini valvole a sfera per aria compressa e fluidi industriali



Altre Linee di Prodotti:



■ Elettrovalvole Serie CFB INOX



■ Cilindri in Acciaio Inox Serie 90



■ Cilindri in Acciaio Inox Serie 94 e 95

Contatti

Camozzi Automation S.p.A.

Società Unipersonale
Via Eritrea, 20/I
25126 Brescia
Italia
Tel. +39 030 37921
info@camozzi.com

Assistenza Clienti

Tel. +39 030 3792790
service@camozzi.com

Segreteria Commerciale

Tel. +39 030 3792255
commerciale@camozzi.com



Automation

