

Series MX soft start valves

MX2 ports: G3/8, G1/2, G3/4 - MX3 ports: G3/4, G1
Modular



- » Opening of the main air path at about 50% of the value of the inlet pressure
- » Pressure switches available on request

These soft start valves allow a gradual increase of the pressure in pneumatic systems. The pressure increases slowly according to the set regulation until it reaches half of the set value, then it increases rapidly. The valve poppet shifts slowly and securely to the open position to prevent sudden and unsafe movements of the pneumatic components in the system.

The Series MX has been realized to offer a multi-sector solution that guarantees saving in terms of installation time, space and costs.

A special configurator, available on Camozzi website at <http://catalogue.camozzi.com> (sec. Configurators), allows the customer to choose the most suitable solution for his application, selecting single components or by configuring assembled FRLs.

GENERAL DATA

Construction	modular, compact, poppet-type
Materials	see TABLE OF MATERIALS on the following page
Ports	MX2: G3/8 - G1/2 - G3/4 MX3: G3/4 - G1
Mounting	in-line wall-mounting (by means of clamps)
Operating temperature	-5°C ÷ 50°C up to 16 bar (with the dew point of the fluid lower than 2°C at the min. working temperature) -5°C ÷ 60°C up to 10 bar (with the dew point of the fluid lower than 2°C at the min. working temperature)
Operating pressure	2 ÷ 16 bar
Nominal flow (at 6 bar with ΔP 1 bar)	MX2: 5800 l/min (G1/2, G3/4) MX2: 4500 l/min (G3/8) MX3: 8500 l/min
Fluid	compressed air

CODING EXAMPLE

MX	2	-	3/8	-	AV	-	LH
MX	SERIES						
2	SIZE: 2 = G3/8 - G1/2 - G3/4 3 = G3/4 - G1						
3/8	PORT: 3/8 = G3/8 1/2 = G1/2 3/4 = G3/4 1 = G1						
AV	SOFT START VALVE						
LH	FLOW DIRECTION: = from left to right (standard) LH = from right to left						

For the assembly of a single component with fixing flanges or wall-mounting, see the section "FRL Series MX Assembled"

Soft start valves Series MX - materials

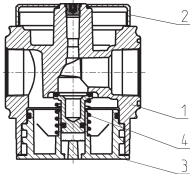

PARTS	MATERIALS
1 = Body	Aluminium
2 = Covering	Polyacetal
3 = Valve holder plug	Polyacetal
4 = Lower spring	Stainless steel
Seals	NBR

MX2 DIAGRAMS FOR PRESSURISATION TIMES

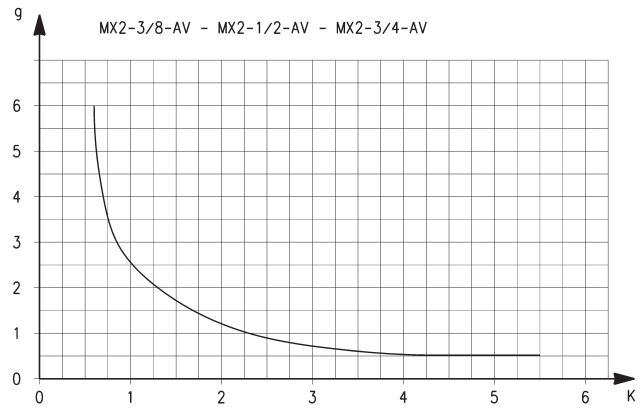
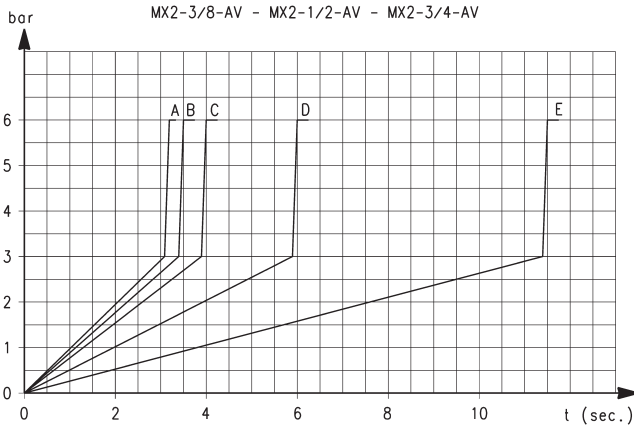

Pressurisation times as to the number of turns of the regulation screw, with downstream volume of 5 litres. A = 5 turns - B = 4 turns - C = 3 turns - D = 2 turns - E = 1 turn. K = number of turns of the regulation screw required to obtain the required pressurisation time with an inlet pressure of 6 bar. Variations of the inlet pressure can cause deviations of the pressure time by ± 20%. $K = t/V$ where: V = volume of the downstream system in litres; t = desired pressuring time in seconds.

EXAMPLE:
V = 5 litres
t = 16 seconds
 $K = 16/5 = 3,2$

Using in the graph this value K, the number of turns of the regulation screw will be approx. 0,8.

MX3 DIAGRAMS FOR PRESSURISATION TIMES

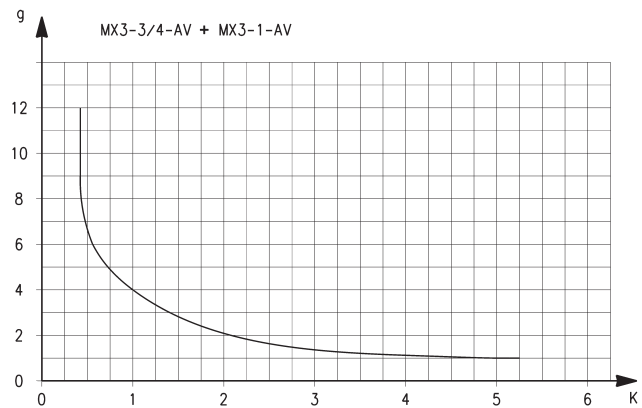
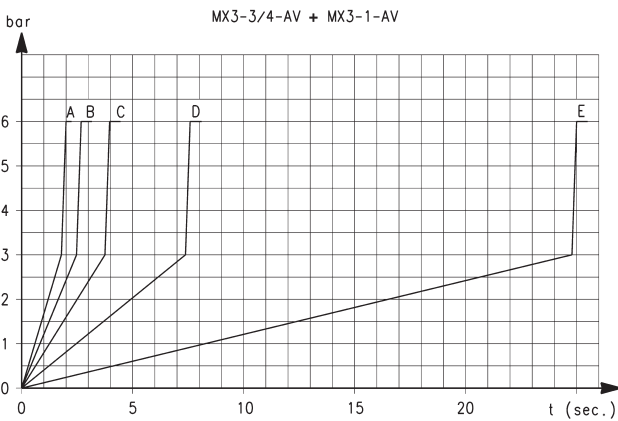

Pressurisation times as to the number of turns of the regulation screw, with downstream volume of 5 litres. A = 5 turns - B = 4 turns - C = 3 turns - D = 2 turns - E = 1 turn. K = number of turns of the regulation screw required to obtain the required pressurisation time with an inlet pressure of 6 bar. Variations of the inlet pressure can cause deviations of the pressure time by ± 20%. $K = t/V$ where: V = volume of the downstream system in litres; t = desired pressuring time in seconds.

EXAMPLE:
V = 5 litres
t = 16 seconds
 $K = 16/5 = 3,2$

Using in the graph this value K, the number of turns of the regulation screw will be approx. 1,8.

Soft start valves Series MX - dimensions

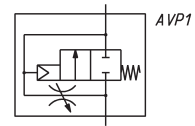
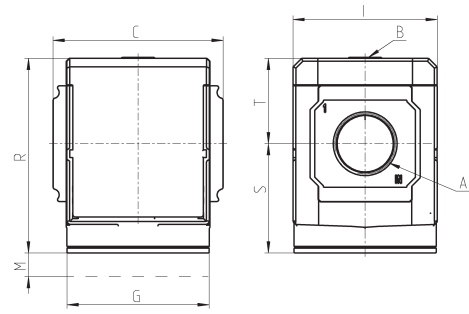

Mod.	A	B	C	G	I	M	R	S	T	Weight (kg)
MX2-3/8-AV	G3/8	G1/8	70	65	68	46,5	88	50,5	37,5	0.4
MX2-1/2-AV	G1/2	G1/8	70	65	68	46,5	88	50,5	37,5	0.4
MX2-3/4-AV	G3/4	G1/8	70	65	68	46,5	88	50,5	37,5	0.4
MX3-3/4-AV	G3/4	G1/8	89,5	75	76	48	102	57,5	44,5	0.7
MX3-1-AV	G1	G1/8	89,5	75	76	48	102	57,5	44,5	0.7

AVP1 = soft start valve