

# Pressure switches, Transducers, Pressure indicators

Series PM: adjustable-diaphragm pressure switches, with setting visual scale, with exchange contacts

Series TRP: electro-pneumatic transducers

Series 2950: pressure indicators, ports M5



Series PM diaphragm pressure switches are available with NC (normally closed) contacts and with NO (normally open) contacts.

Series PM681 pressure switches with setting visual scale comply with EN60730 standards and are suitable for signalling pressure through a normally closed Reed contact.

A regulating screw, which can be adjusted using a small screwdriver, allows the switch to be set to the required pressure. The calibrated diaphragm enables an electrical signal to be generated or inhibited depending on the pressure set.

## GENERAL DATA

Construction	with adjustable diaphragm
Ports	R1/8, G1/4 (Serie PM) tube 4/2 (Series TRP) M5 (Series 2950)
Mounting	using thread in body
Max. nr. of pulses per 1'	200
Pressure	1 ÷ 10 bar max.
Operating temperature	-5°C ÷ +60°C
Max. power	100 VA
Voltage	220 V
Isolation voltage	1500 V
Max current	0.5 A
Pressure switches protection class	IP40 (Mod. PM681-1, PM681-3) IP54 (Mod. PM11-NC, PM11-NA) IP65 (Mod. PM11-SC)

### Series PM adjustable-diaphragm pressure switches



Supplied with a rubber cap providing protection class IP54.

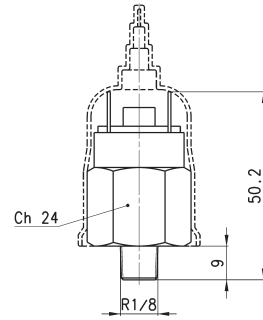

PMNC = normally closed  
PMNO = normally open

Mod.	Function	Max Voltage	Max Power	Service Type	Insulation voltage	Symbol
PM11-NC	NC = normally closed	48 V AC DC	24 VA	Heavy	500 V	PMNC
PM11-NA	NA = normally open	48 V AC DC	24 VA	Heavy	500 V	PMNO

### Series PM681-... - pressure switches with setting visual scale



In compliance with EN60730 standard  
Protection class IP40  
Electric connection: PVC cable 2 x 0.22 mm  
Electric contact: Reed SPST NO  
Body in anodized aluminium and threaded fitting in brass  
Hysteresis: 0.8 bar max

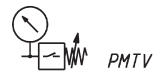
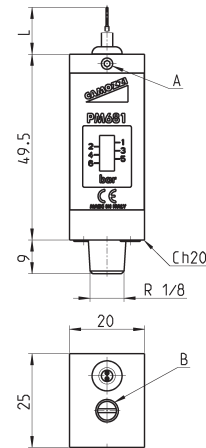

A = SETTING GRAIN LOCKING

B = ADJUSTMENT SCREW

Mod.	L	Max switch voltage	Max switch current	Max switch capacity	Max fluid temperature	Max pressure	Setting range	Weight
PM681-1	1 m	48 V	0.5 A	10 W	60°C	20 bar	1 ÷ 6 bar	95 g
PM681-3	3 m	48 V	0.5 A	10 W	60°C	20 bar	1 ÷ 6 bar	95 g

### Pressure switch with exchange contacts Mod. PM11-SC



Protection class IP65  
(with connector Mod. 124-830)

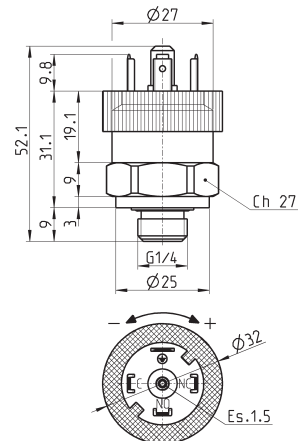

(\*) SC = exchange contacts

DIMENSIONS							
Mod.	Function	Max Voltage	Operating Temperature	Actuation time	Setting range	Max Hysteresis	
PM11-SC	SC (*)	250V AC - 30V DC	-25°C +85°C	> 0,1 ms	2 ÷ 10 bar	0.8 bar	

### Electro-pneumatic transducer Series TRP



Series TRP electro-pneumatic transducer is particularly suitable to convert a pneumatic signal into an electrical signal. The contacts are NC (normally closed) or NO (normally open), thus making it possible to generate or eliminate current when the pneumatic signal is present. Minimum operating pressure 2,5 bar.

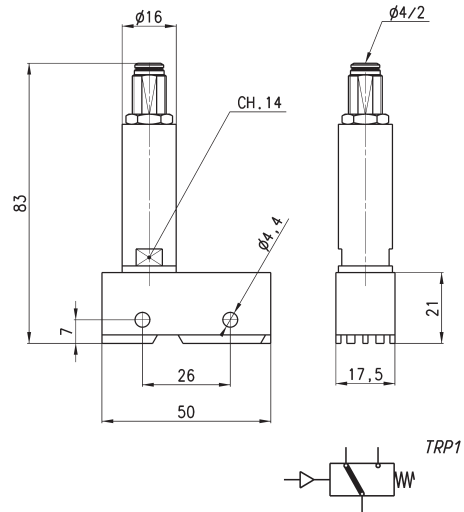

Mod.	TRP-8
------	-------

### Pressure indicators Series 2950



The pressure indicator Mod. 2950-M5 is passive element (no spring, red colour). It is useful for detecting pressure manually without having to remove the connections.

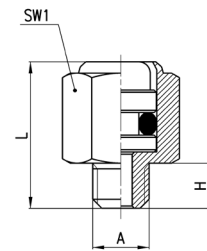

DIMENSIONS				
Mod.	A	H	L	SW1
2950 M5	M5	4	13.5	8

### 3-pole connector Mod. 124-830 for pressure switch Mod. PM11-SC

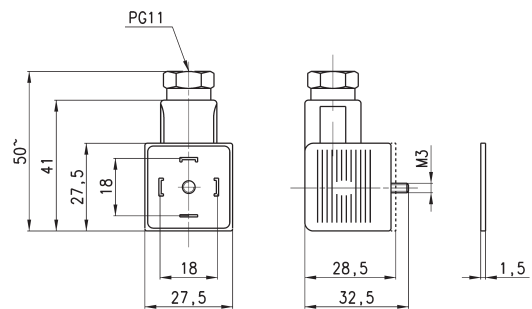

Mod.	description	colour	working voltage	cable holding	tightening torque
124-830	three-pole connector without electronics	black	-	PG9/PG11	0.5 Nm
124-830EX	three-pole ATEX connector without electronics	black	-	PG9/PG11	0.5 Nm