

Series 7000 Fluidics in technopolymer for water cooling applications

Tube external diameters: 6, 8, 10, 12, 16 mm

Fittings threads: BSP (G1/8, G1/4, G3/8, G1/2, G3/4), M5



Series 7000 Fluidics push-in fittings enable smooth passage of fluids in cooling systems. Liquid cooling systems are considered to be better than air cooling, in terms of efficiency, effectiveness, compactness and noise in a wide range of applications from computer servers to industrial equipment. The Series 7000 Fluidics fitting range has been designed with a special technopolymer, based on renewable raw materials, that allows the component to resist water absorption, temperature variations and cooling liquid additives. The material maintains constant dimensional stability in contact with different fluids and does not breakdown with age.

Advanced gripping characteristics make the Series 7000 Fluidics an excellent alternative to traditional fittings, guaranteeing a uniform tightening on the whole surface of the tube. This enhances high reliability and resistance to repeated connections and disconnections of the tube. Reliable connection, compact dimensions and easy installation in confined spaces are only some of the features that make these new fittings an innovative solution for a wide range of cooling systems.

- » BENEFITS:
- » Easy to connect and disconnect
- » Resistant to water pressure and erosion
- » Resistant to corrosion
- » Dimensional stability with water contact
- » Long life cycle

GENERAL DATA

Diameters	Ø6mm	Ø8mm	Ø10mm	Ø12mm	Ø16mm
Working pressure at -20°/+40°	16bar	16bar	14bar	14bar	12bar
Working pressure at -20°/+70°	16bar	14bar	12bar	10bar	8bar
Working pressure at -20°/+100°	14bar	12bar	10bar	8bar	6bar
Threads	GAS cylindrical ISO-228 (BSPP)				
Tube to connect	Polyurethane (PU), Polyethylene (PE), Polyamide (PA), Fluoropolymer (PTFE)				
Medium	Suitable for use with industrial water supplies and specialist cooling fluids. (Please contact us to discuss suitability for other fluids).				
Materials	Body: Technopolymer PA11, Seals: EPDM. Threads: Chemical Nickel Plating. Collet (not in contact with cooling fluids): nickel Plated				

Fitting with connecting tube

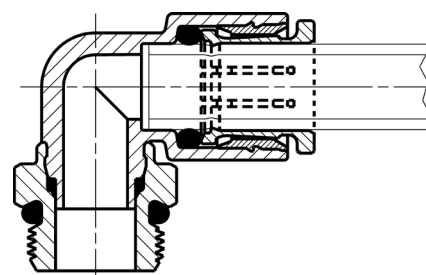

Fittings Mod. F6512K



BSP Male Connector

* = Integrated Locking Clip to secure the collet in its position

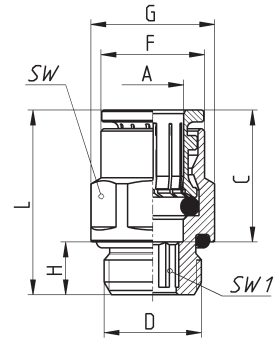

DIMENSIONS										
Mod.	A	D	C	F	G	H	L	SW	SW1	Weight (g)
F6512 6-1/8K	6	G1/8	16.0	11.7	13.5	6	21	12	4	10
F6512 6-1/4K	6	G1/4	16.0	11.7	16.4	7	22	15	4	13
F6512 8-1/8K	8	G1/8	17.5	13.7	15.2	6	26	14	5	15
F6512 8-1/4K	8	G1/4	17.5	13.7	16.4	7	24.5	15	6	17
F6512 8-3/8K	8	G3/8	17.5	13.7	20.5	7	23	19	6	27
F6512 10-1/4K	10	G1/4	20.2	15.4	18.5	7	30	17	7	26
F6512 10-3/8K	10	G3/8	20.2	15.4	20.5	7	24.5	19	8	27
F6512 10-1/2K	10	G1/2	20.2	15.4	24.8	8	25	22	8	39
F6512 12-3/8K	12	G3/8	19.2	18.3	20.5	7	24	19	9	24
F6512 12-1/2K	12	G1/2	19.2	18.3	24.8	8	24.5	22	9	37
F6512 16-1/2K*	16	G1/2	23.0	23.5	26.5	8	33.5	24	-	49
F6512 16-3/4K*	16	G3/4	23.0	23.5	30	9	29.5	24	-	58

Fittings Mod. F6463K



BSP Female Connector

* = Integrated Locking Clip to secure the collet in its position

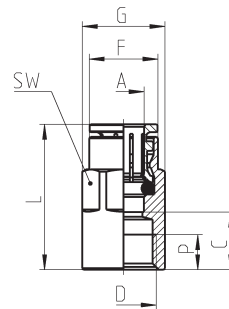

DIMENSIONS										
Mod.	A	D	C	F	G	L	P (min)	SW	Weight (g)	
F6463 6-1/8K	6	G1/8	10	11.7	13	26	6	12	14	
F6463 6-1/4K	6	G1/4	11.5	11.9	16.5	27.5	7	15	23	
F6463 8-1/8K	8	G1/8	9.5	13.7	15.2	27	6	14	16	
F6463 8-1/4K	8	G1/4	11.5	13.7	16.5	29	7	15	23	
F6463 8-3/8K	8	G3/8	13	13.7	20	30.5	8	15	29	
F6463 10-1/4K	10	G1/4	11.3	15.4	18.5	31.5	7	17	29	
F6463 10-3/8K	10	G3/8	12.8	15.4	20	33	8	17	34	
F6463 10-1/2K	10	G1/2	16.8	15.4	24	37	9.5	17	44.5	
F6463 12-3/8K	12	G3/8	12.8	18.3	20.5	32	8	19	40	
F6463 12-1/2K	12	G1/2	16.8	18.3	24	36	9.5	19	50.5	
F6463 16-1/2K*	16	G1/2	16.5	23.5	26.5	40	9.5	24	63	
F6463 16-3/4K*	16	G3/4	18.5	23.5	30	42	11	24	77	

Fittings Mod. F6700K

Cartridge



S* = for both metallic and synthetic seat

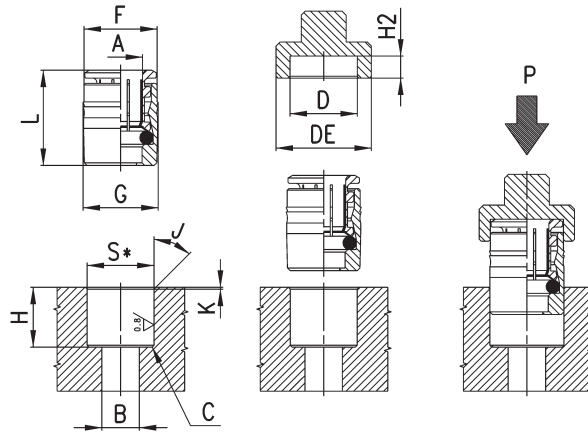

Mod.	A	B	C	D	DE	F	G	H	H2 (+0,1/0)	J	K	L	P min (Kg)	P max (Kg)	S (+0,01/-0,04)	Weight (g)
F6700 6K	6	4	0.5x45°	12	17	11.8	12.2	12	3.8	15°	0.5	16.5	160	570	11.95	8
F6700 8K	8	6	0.5x45°	14	19	13.8	14.2	14	3.3	15°	0.5	18	140	400	13.95	11
F6700 10K	10	8	0.5x45°	16	21	15.8	16.2	16.5	3.5	15°	0.5	20.5	150	650	15.95	15

Fittings Mod. F7522K

BSP Male Swivel Elbow



* = Integrated Locking Clip to secure the collet in its position

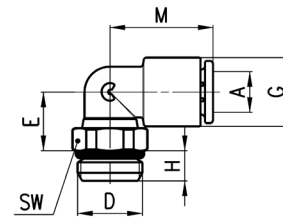

DIMENSIONS								
Mod.	A	D	E	G	H	M	SW	Weight (g)
F7522 6-M5K	6	M5	9.3	11.4	3.5	18.5	9	7
F7522 6-1/8K	6	G1/8	10	11.6	5	18.5	12	8
F7522 6-1/4K	6	G1/4	10	11.6	6	18.5	14	11
F7522 8-1/8K	8	G1/8	13.5	13.9	5	20.5	12	11
F7522 8-1/4K	8	G1/4	12	13.9	6	20.5	14	13
F7522 8-3/8K	8	G3/8	12.5	13.9	7	20.5	19	21
F7522 10-1/4K	10	G1/4	14.5	16.1	6	24	14	15
F7522 10-3/8K	10	G3/8	13.5	16.1	7	24	19	21
F7522 10-1/2K	10	G1/2	13.5	16.1	8	24	24	30
F7522 12-1/4K	12	G1/4	16	20.2	6	28	17	20
F7522 12-3/8K	12	G3/8	15	20.2	7	28	19	25
F7522 12-1/2K	12	G1/2	15.5	20.2	8	28	24	34
F7522 16-1/2K*	16	G1/2	30	27	8	33.5	24	61
F7522 16-3/4K*	16	G3/4	24	27	9	33.5	30	70

Fittings Mod. F7526K



Long BSP Male Swivel Elbow

* = Integrated Locking Clip to secure the collet in its position

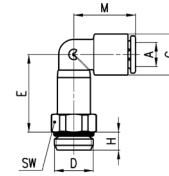

DIMENSIONS								
Mod.	A	D	E	G	H	M	SW	Weight (g)
F7526 6-1/8K	6	G1/8	23	11,6	5	18,5	12	13
F7526 6-1/4K	6	G1/4	23	11,6	5	18,5	14	16
F7526 8-1/8K	8	G1/8	29	13,9	5	20,5	12	18
F7526 8-1/4K	8	G1/4	27	13,9	6	20,5	14	20
F7526 8-3/8K	8	G3/8	27,7	13,9	7	20,5	19	30
F7526 10-1/4K	10	G1/4	32,2	15,8	6	24	14	28,5
F7526 10-3/8K	10	G3/8	32,2	15,8	7	24	19	35
F7526 10-1/2K	10	G1/2	32,2	15,8	8	24	24	45
F7526 12-3/8K	12	G3/8	36,2	20	7	28	19	41,5
F7526 12-1/2K	12	G1/2	36,2	20	8	28	24	49,5
F7526 16-1/2K*	16	G1/2	58,9	27	8	34	24	106,5
F7526 16-3/4K*	16	G3/4	58,9	27	9	34	30	116

Fittings Mod. F7550



Elbow Connector

* = Integrated Locking Clip to secure the collet in its position

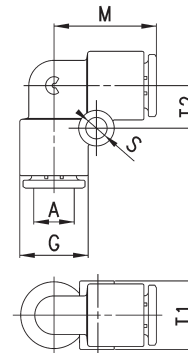

DIMENSIONS							
Mod.	A	G	M	S	T1	T2	Weight (g)
F7550 6	6	11,6	18,5	4	11,4	7,5	6
F7550 8	8	13,9	20,5	4	13,7	8,5	9
F7550 10	10	16,1	24	4	15,8	8	12
F7550 12	12	20,2	28	4	9	9,6	20
F7550 16*	16	27	33,5	-	-	-	42

F7550 16 = model without mounting holes

Fittings Mod. F7580



Union Connector

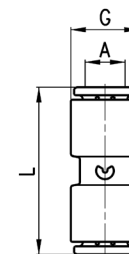

DIMENSIONS				
Mod.	A	G	L	Weight (g)
F7580 6	6	11,6	31	6
F7580 8	8	13,9	33,5	9
F7580 10	10	16,1	38,5	11
F7580 12	12	20,2	39,5	18

Fittings Mod. F7540

Tee Connector



* = Integrated Locking Clip to secure the collet in its position

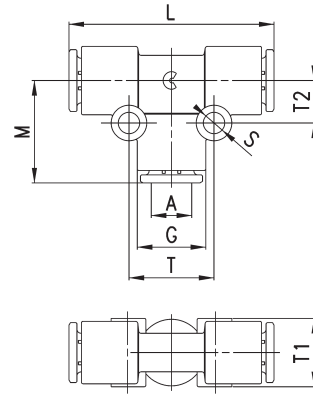

DIMENSIONS									
Mod.	A	G	L	M	S	T	T1	T2	Weight (g)
F7540 6	6	11,6	37	18,5	4	15	11,4	7,5	9
F7540 8	8	13,9	41	20,5	4	17	13,7	8,5	14
F7540 10	10	16,1	48	24	4	16	15,8	8	18
F7540 12	12	20,2	56	28	4	19,2	9	9,6	30
F7540 16*	16	27	67	33,5	-	-	-	-	61

F7540 16 = model without mounting holes

Fittings Mod. F7560

Y Connector - Reducer

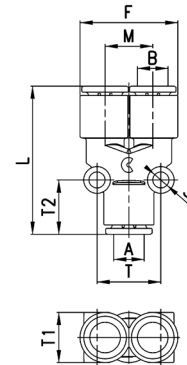

DIMENSIONS										
Mod.	A	B	F	L	M	S	T	T1	T2	Weight (g)
F7560 6	6	6	23	35	11,4	4	14,5	11,5	13,5	9
F7560 8	8	8	27,2	39,5	13,5	4	17	14	14,5	15
F7560 10	10	10	31,7	46	15,8	4	16,5	16	16,5	19

Fittings Mod. F7545

Multi Tee Reducer

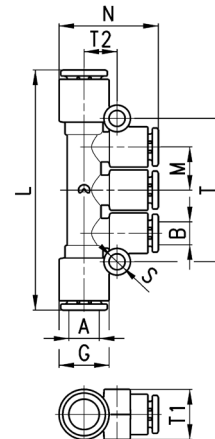

DIMENSIONS											
Mod.	A	B	G	L	M	N	S	T	T1	T2	Weight (g)
F7545 8-6	8	6	13,9	64	11,5	26,5	4	38,2	13,5	9	18
F7545 10-8	10	8	16,1	78,5	14,1	30	4	45,8	16	10,5	27

Fittings Mod. F7555

Junction Elbow

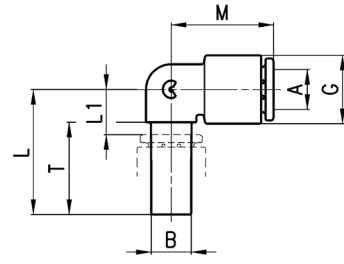

DIMENSIONS								
Mod.	A	B	G	L	L1	M	T	Weight (g)
F7555 6-6	6	6	11,6	23	8	18,5	17,5	4
F7555 8-8	8	8	13,9	25	9	20,5	18,5	5
F7555 10-10	10	10	16,1	28,5	10	24	21	8
F7555 12-12	12	12	20,2	32	13	28	23	12

Fittings Mod. F7800

Reducer Junction

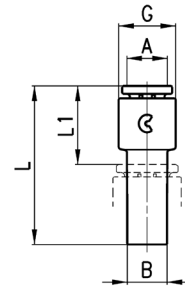

DIMENSIONS						
Mod.	A	B	G	L1	L	Weight (g)
F7800 4-6	4	6	9,4	14,5	29,5	2
F7800 4-8	4	8	9,4	14,5	30,5	3
F7800 6-8	6	8	11,6	15,5	31,5	4
F7800 6-10	6	10	11,6	15,5	34	4
F7800 6-12	6	12	11,6	16,5	35,5	4
F7800 8-10	8	10	13,9	16,5	35	5
F7800 8-12	8	12	13,9	17,5	37	6
F7800 10-12	10	12	16,1	18,5	37,5	7

Fittings Mod. F6750K

Female Plug

* = Integrated Locking Clip to secure the collet in its position

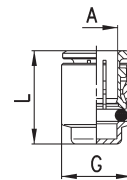

DIMENSIONS				
Mod.	A	G	L	Weight (g)
F6750 6K	6	11.8	17	7
F6750 8K	8	13.8	18.5	9
F6750 10K	10	15.8	21	12
F6750 12K	12	17.8	20	15
F6750 16K*	16	23.5	24.5	26

Accessory Mod. 6900



Plastic Male Plug

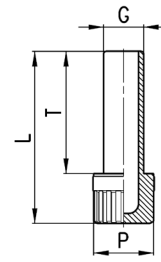

DIMENSIONS					
Mod.	G	L	P	T	Weight (g)
6900 6	6	31.5	8	22.5	1
6900 8	8	34.5	12	24.5	2
6900 10	10	37	12	27	2
6900 12	12	40.5	16	28.5	3

Fittings Mod. 2611

BSP Male Plug

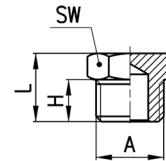

DIMENSIONS					
Mod.	A	H	L	SW	Weight (g)
2611 1/8	G1/8	6	10,5	13	7
2611 1/4	G1/4	8	13	17	13
2611 3/8	G3/8	9	14	19	18
2611 1/2	G1/2	10	15,5	24	31
2611 1	G1	13	19	38	76

Accessories Mod. 3033

4 Ways Distribution Block with fixing holes
Material: anodized Aluminium

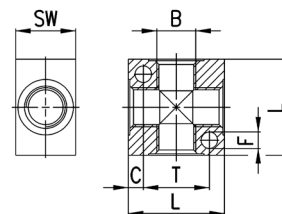
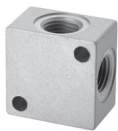

DIMENSIONS							
Mod.	B	C	F	L	T	SW	Weight (g)
3033 1/8	G1/8	4	4,5	25	17	16	18
3033 1/4	G1/4	5	5,5	32	22	20	35
3033 3/8	G3/8	7	5,5	40	26	25	73
3033 1/2	G1/2	8	5,5	50	34	30	137

Accessories Mod. 3043

Manifold with double lateral outlets
Material: anodized Aluminium

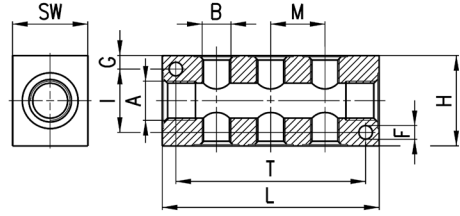

DIMENSIONS												
Mod.	A	DOUBLE LATERAL OUTLETS	B	F	G	H	I	L	M	T	SW	Weight (g)
3043 1/4-3D-1/8	G1/4	3	G1/8	4.5	4.5	30	21	72	18	63	20	85
3043 1/4-4D-1/8	G1/4	4	G1/8	4.5	4.5	30	21	90	18	81	20	107
3043 1/4-5D-1/8	G1/4	5	G1/8	4.5	4.5	30	21	108	18	99	20	128
3043 1/4-6D-1/8	G1/4	6	G1/8	4.5	4.5	30	21	126	18	117	20	151
3043 3/8-3D-1/4	G3/8	3	G1/4	5.5	6	40	28	92	24	75	25	177
3043 3/8-4D-1/4	G3/8	4	G1/4	5.5	6	40	28	116	24	99	25	224
3043 3/8-5D-1/4	G3/8	5	G1/4	5.5	6	40	28	140	24	123	25	270
3043 3/8-6D-1/4	G3/8	6	G1/4	5.5	6	40	28	164	24	147	25	315
3043 1/2-3D-3/8	G1/2	3	G3/8	5.5	6.5	50	37	104	26	85	30	287
3043 1/2-4D-3/8	G1/2	4	G3/8	5.5	6.5	50	37	130	26	111	30	356
3043 1/2-5D-3/8	G1/2	5	G3/8	5.5	6.5	50	37	156	26	137	30	427
3043 1/2-6D-3/8	G1/2	6	G3/8	5.5	6.5	50	37	182	26	163	30	495

Accessories Mod. 3053

Manifold with lateral outlets
Material: anodized Aluminium

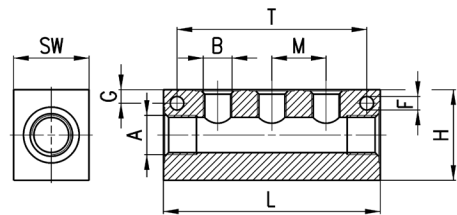

DIMENSIONS												
Mod.	A	SINGLE LATERAL OUTLETS	B	F	G	H	L	M	T	SW	Weight (g)	
3053 1/4-3L-1/8	G1/4	3	G1/8	4.5	4.5	30	72	18	63	20	92	
3053 1/4-4L-1/8	G1/4	4	G1/8	4.5	4.5	30	90	18	81	20	116	
3053 1/4-5L-1/8	G1/4	5	G1/8	4.5	4.5	30	108	18	99	20	140	
3053 1/4-6L-1/8	G1/4	6	G1/8	4.5	4.5	30	126	18	117	20	164	
3053 3/8-3L-1/4	G3/8	3	G1/4	5.5	6	40	92	24	75	25	191	
3053 3/8-4L-1/4	G3/8	4	G1/4	5.5	6	40	116	24	99	25	243	
3053 3/8-5L-1/4	G3/8	5	G1/4	5.5	6	40	140	24	123	25	294	
3053 3/8-6L-1/4	G3/8	6	G1/4	5.5	6	40	164	24	147	25	345	
3053 1/2-3L-3/8	G1/2	3	G3/8	5.5	6.5	50	104	26	85	30	313	
3053 1/2-4L-3/8	G1/2	4	G3/8	5.5	6.5	50	130	26	111	30	395	
3053 1/2-5L-3/8	G1/2	5	G3/8	5.5	6.5	50	156	26	137	30	474	
3053 1/2-6L-3/8	G1/2	6	G3/8	5.5	6.5	50	182	26	163	30	551	