

# VACUUM CUP FILTERS

## SERIES FVT

Used as pre-filters and fine filters for air with varying amounts of contamination, for the protection of the vacuum generator. Mounted as protection for the ejector.



- Wide range of sizes
- Recycling filter cartridge
- Replaceable filter element
- Transparent filter cup to check the filter's conditions

These filters can be mounted directly under the ejectors to protect them in case of dusty environmental conditions. The filter element can be substituted very easily and its conditions can be checked thanks to its transparent wrapping. These filters can be wall-mounted through a proper bracket. Filtering of vacuum and air up to 7 bar.

### GENERAL DATA

<b>Description</b>	Cup filter
<b>Materials</b>	- body in technopolymer - filter in polyethylene (PE)

VACUUM CUP FILTERS  
**SERIES FVT - CODING EXAMPLE**

**CODING EXAMPLE**

<b>FVT</b>	<b>-</b>	<b>FF</b>	<b>-</b>	<b>1/4</b>	<b>-</b>	<b>80</b>
<b>FVT</b>	SERIES FVT = cup filter					
<b>FF</b>	THREAD SIZE FF = female-female					
<b>1/4</b>	CONNECTIONS 1/8 = G1/8 1/4 = G1/4 3/8 = G3/8 1/2 = G1/2 3/4 = G3/4					
<b>80</b>	FILTER ELEMENT 80 = 80 µm					

**Technical data**

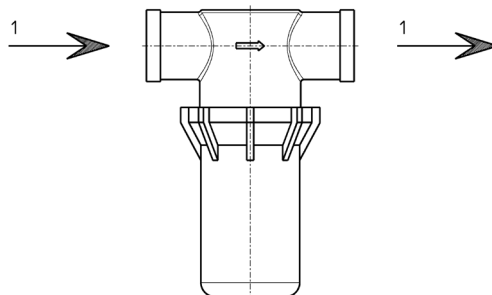

Mod.	Filter element (µm)	Nominal flow (l/min)	Max vacuum (mbar)	Max pressure at 25°C (bar)	Max pressure at 50°C (bar)	Weight (kg)
FVT-FF-1/8-80	80	45	-990	7	5	0,049
FVT-FF-1/4-80	80	110	-990	7	5	0,047
FVT-FF-3/8-80	80	245	-990	7	5	0,079
FVT-FF-1/2-80	80	300	-990	7	5	0,076
FVT-FF-3/4-80	80	600	-990	7	5	0,164

## Diagrams FVT

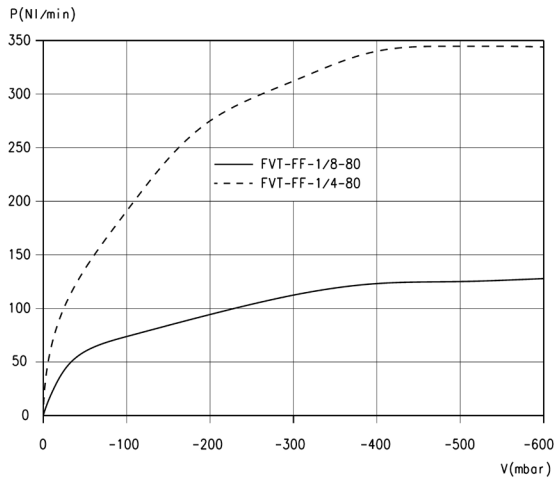

**LEGEND:**  
P = Volumetric flow  
V = Vacuum values

Flow rate for different vacuum values

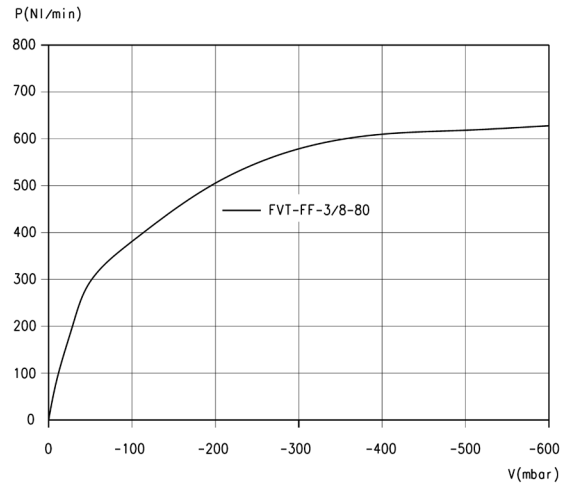

**LEGEND:**  
P = Volumetric flow  
V = Vacuum values

Flow rate for different vacuum values

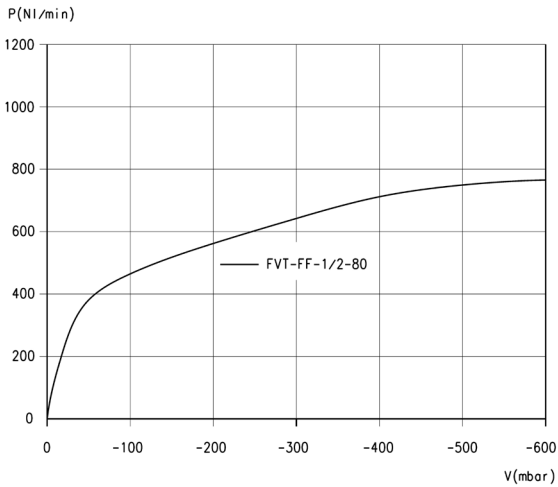

**LEGEND:**  
P = Volumetric flow  
V = Vacuum values

Flow rate for different vacuum values

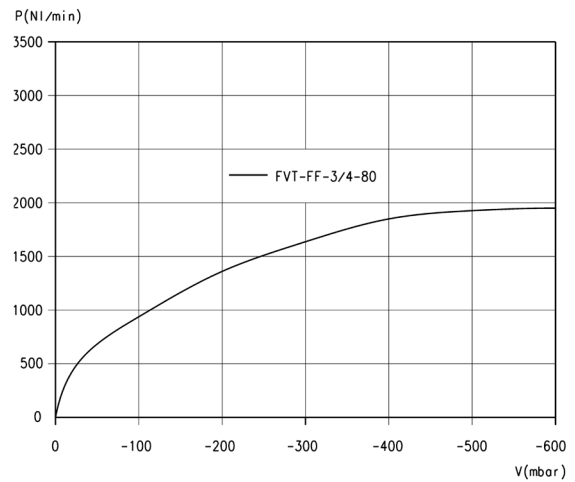

**LEGEND:**  
P = Volumetric flow  
V = Vacuum values

Flow rate for different vacuum values

## Cup filter

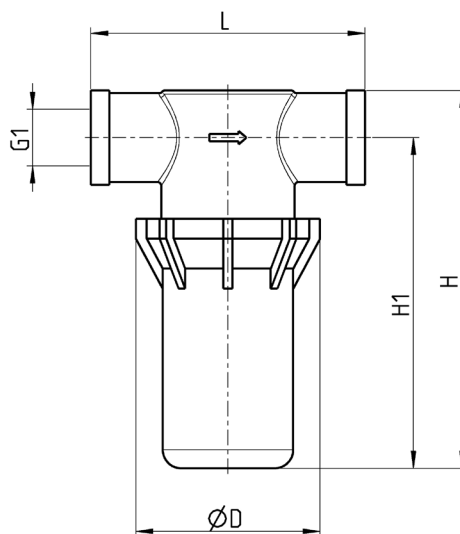

Mod.	D	G1	H	H1	L
FVT-FF-1/8-80	48	G1/8-F	60	50	58
FVT-FF-1/4-80	48	G1/4-F	60	50	76
FVT-FF-3/8-80	48,5	G3/8-F	97	84	77,2
FVT-FF-1/2-80	48	G1/2-F	101	88	77,2
FVT-FF-3/4-80	75	G3/4-F	137	118	90,5

## Mounting foot bracket



The mod. FVT-FF-1/8-80-B is used on cup filters with ports G1/8, G1/4, G3/8 e G1/2.  
The mod. FVT-FF-3/4-80-B is used on cup filters with ports G3/4.

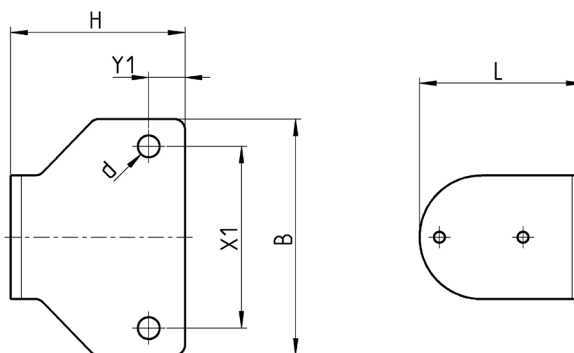

Mod.	B	d	H	L	X1	Y1
FVT-FF-1/8-80-B	65	6	48	45	50	10
FVT-FF-3/4-80-B	85	6	52	70	70	10