



# GRIPfit push-in fittings Series 7000 - Cooling

Tube external diameters: 6, 8 mm

Fittings threads: ISO-228 BSPP (G1/8, G1/4, G3/8).



- » Resistant to water pressure and erosion
- » Dimensional stability with water contact
- » Resistant to corrosion

Series 7000 Cooling push-in fittings have been designed with a special technopolymer based on bio-sourced renewable raw materials that allow the component to resist water absorption, temperature variations and liquid cooling additives.

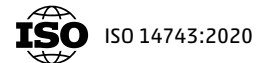

## GENERAL DATA

<b>Diameters</b>	ø 6 mm - ø 8 mm
<b>Maximum operating pressure</b>	- 20° / + 40° 16 bar - 16 bar + 40° / + 70° 14 bar - 12 bar + 70° / + 100° 12 bar - 10 bar
<b>Minimum operating Pressure</b>	-0,9 bar
<b>Temperature</b>	- 20 ÷ + 100 (See characteristics of tubes used)
<b>Threads</b>	GAS cylindrical ISO-228 BSPP
<b>Connecting tubes</b>	Polyurethane (PU), Polyethylene (PE), Polyamide (PA), Fluoropolymer (PTFE), Polyester (HY3L), rigid metal pipe with smooth grooved metal end
<b>Fluid</b>	Industrial water and cooling fluids (for other fluids consult our technicians)
<b>Materials</b>	(A) Body = Technopolymer (PA11), Brass with chemical nickel plating (B) Button = Technopolymer (PA66) (C) Gripping ring= Stainless steel (AISI 301) (D) Seals = EPDM (E) Thread = Brass with chemical nickel plating

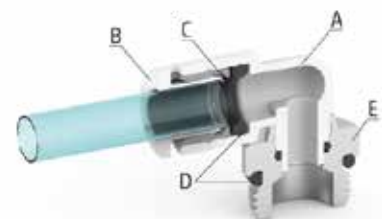

### Fittings Mod. W6512



Male straight connector  
Chemical nickel-plated brass  
Thread BSPP ISO-228

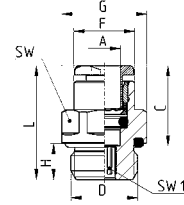

Mod.	A	D	C	F	G	H	L	SW	SW1	Weight (g)
W6512 6-1/8	6	G1/8	15,5	11,7	13,5	6	21	12	4	8
W6512 6-1/4	6	G1/4	15,5	11,7	16,4	7	22	15	4	11
W6512 8-1/8	8	G1/8	17,3	13,7	15,2	6	26	14	5	12
W6512 8-1/4	8	G1/4	17,3	13,7	16,4	7	24,5	15	6	14
W6512 8-3/8	8	G3/8	17,3	13,7	20,5	7	24	19	7	24

### Fittings Mod. W6463



Female straight connector  
Chemical nickel-plated brass  
Thread BSPP ISO-228

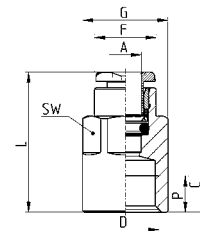

Mod.	A	D	C	F	G	L	P(min)	SW	Weight (g)
W6463 6-1/8	6	G1/8	10	11,7	13	25,5	6	12	13
W6463 6-1/4	6	G1/4	11,5	11,9	16,5	27	7	15	21,5
W6463 8-1/8	8	G1/8	9,5	13,7	15,2	27	6	14	13,5
W6463 8-1/4	8	G1/4	11,5	13,7	16,5	29	7	15	20,5
W6463 8-3/8	8	G3/8	12,5	13,7	20,5	30	8	19	25

**Fittings Mod. W6750**

Female plug  
Chemical nickel-plated brass

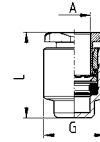

Mod.	A	G	L	Weight (g)
W6750 6	6	11,8	16,5	4,5
W6750 8	8	13,8	18,3	5,5

**Fittings Mod. W6812**

Male straight adaptor  
Chemical nickel-plated brass  
Thread BSPP ISO-228

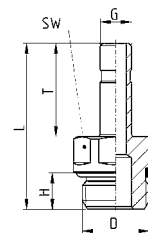

Mod.	D	G	H	L	T	SW	Weight (g)
W6812 6-1/8	G1/8	6	6	30	18	12	9
W6812 6-1/4	G1/4	6	7	32	18	15	17,4
W6812 8-1/8	G1/8	8	6	32,5	20,5	12	10,2
W6812 8-1/4	G1/4	8	7	34,5	20,5	15	17,4
W6812 8-3/8	G3/8	8	7	34,5	20,5	19	25

**Fittings Mod. W7522**

Swivel male elbow  
Thread BSPP ISO-228

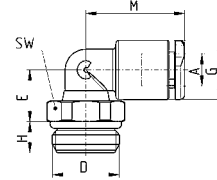

Mod.	A	D	E	G	H	M	SW	Weight (g)
W7522 6-1/8	6	G1/8	10	11,4	5	19	12	8
W7522 6-1/4	6	G1/4	10	11,4	6	19	14	11
W7522 8-1/8	8	G1/8	13,5	13,7	5	21,5	12	11
W7522 8-1/4	8	G1/4	12	13,7	6	21,5	14	14
W7522 8-3/8	8	G3/8	12	13,7	7	21,5	19	19

**Fittings Mod. W7526**

Swivel male long elbow  
Thread BSPP ISO-228

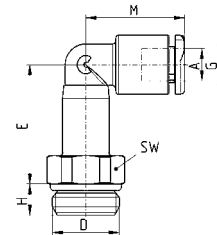

Mod.	A	D	E	G	H	M	SW	Weight (g)
W7526 6-1/8	6	G1/8	23	11,4	5	19	12	13
W7526 6-1/4	6	G1/4	23	11,4	6	19	14	16
W7526 8-1/8	8	G1/8	29	13,7	5	21,5	12	18
W7526 8-1/4	8	G1/4	27	13,7	6	21,5	14	20
W7526 8-3/8	8	G3/8	27,5	13,7	7	21,5	19	24

**Fittings Mod. W7800**

Reducer junction straight

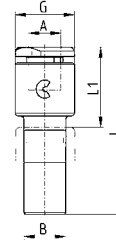

Mod.	A	B	G	L	L1	Weight (g)
W7800 4-6	4	6	9,3	29,5	14	2
W7800 4-8	4	8	9,3	30,5	14	3
W7800 6-8	6	8	11,4	32,5	15,5	4
W7800 6-10	6	10	11,4	34,5	15,5	4
W7800 6-12	6	12	11,4	36,2	15,5	4
W7800 8-10	8	10	13,7	36,2	17,2	5
W7800 8-12	8	12	13,7	37,9	17,2	6

**Fittings Mod. W7555**

Equal junction elbow

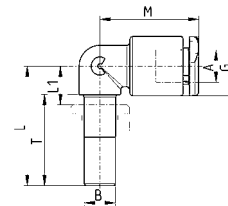

Mod.	A	B	G	L	L1	M	T	Weight (g)
W7555 6-6	6	6	11,4	23	8	19	17,5	4
W7555 8-8	8	8	13,7	25	9	21,5	18,5	5

### Fittings Mod. W7580

Equal intermediate straight

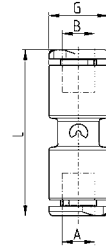

Mod.	A	B	G	L	Weight (g)
W7580 6	6	6	11,4	31,5	6
W7580 8	8	8	13,7	35,4	8

### Fittings Mod. W7550

Equal intermediate elbow

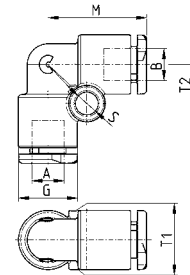

Mod.	A	B	G	M	S	T1	T2	Weight (g)
W7550 6	6	6	11,4	19	4	11,4	7,5	6
W7550 8	8	8	13,7	21,5	4	13,7	8,5	9

**Fittings Mod. W7540**

Equal intermediate tee

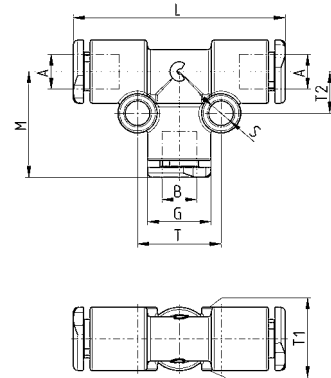

Mod.	A	B	G	L	M	S	T	T1	T2	Weight (g)
W7540 6	6	6	11,4	38	19	4	15	11,4	7,5	9
W7540 8	8	8	13,7	43	21,5	4	17	13,7	8,5	14

**Fittings Mod. W7545**

Reducer intermediate multiple tee

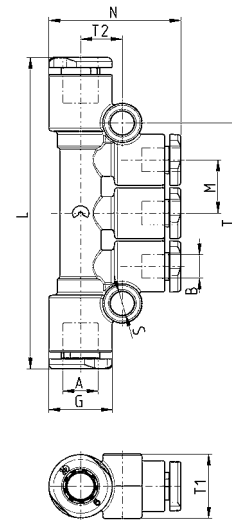

Mod.	A	B	G	L	M	N	S	T	T1	T2	Weight (g)
W7545 8-6	8	6	13,7	66	11,5	27	4	38,2	13,7	9	18

### Fittings Mod. W7560

Equal intermediate Y

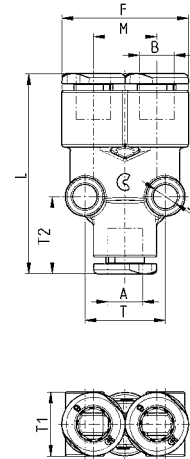

Mod.	A	B	F	L	M	S	T	T1	T2	Weight (g)
<b>W7560 6</b>	6	6	23	36	11,4	4	14,5	11,5	14	9
<b>W7560 8</b>	8	8	27,2	41,5	13,5	4	17	14	15	15

### Accessory Mod. 6900

Plastic male plug

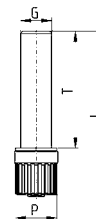

Mod.	G	L	P	T	Weight (g)
<b>B6900 6</b>	6	31,5	8	22,5	1
<b>B6900 8</b>	8	34,5	12	24,5	2



**Groove for metal pipe made by Camozzi grooving tool 8TRT (or machining)**

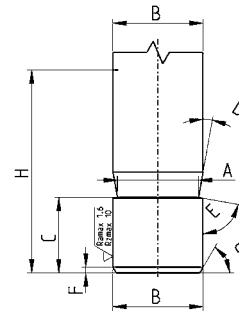

A	B	C	D	E	F	G	H
3,4	4	5,3	10°	80°	0,5	30°	16,5
5,2	6	6,25	10°	80°	0,5	30°	18
7,2	8	6,4	10°	80°	0,5	30°	20

**Groove for metal pipe made by machining**

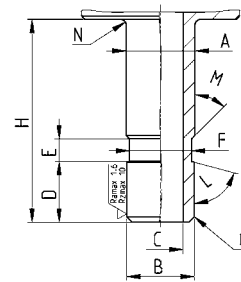

A	B	C	D	E	F	G	H	L	M	N
4,1	4	2	5,3	2	3,5	0,5x45°	16,5	75°	45°	0,5
6,1	6	4	5,4	2	5,5	0,5x45°	18	75°	45°	0,5
8,1	8	6	6	2	7,5	0,5x45°	20,5	75°	45°	0,5

**Grooving tool for metallic tubes**

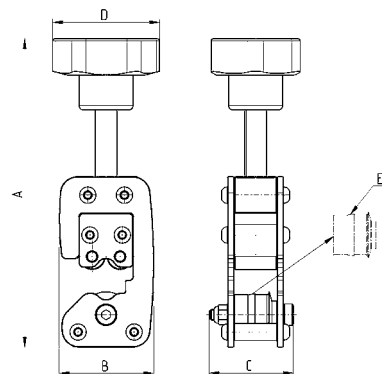

Mod.	Tube Ø	A (max)	B	C	D	Weight (g)	E (spare wheel)
8TRT 4	4	138	43.5	39	50	450	RTRT 4
8TRT 6	6	140	43.5	39	50	450	RTRT 6
8TRT 8	8	142	43.5	39	50	450	RTRT 8