

Brass super-rapid fittings Series HP6000 for Lubrication Applications



Tube external diameters: 4, 6 mm; Fittings threads: metric M5, M6x0,75, M6, M8x1, M10x1, M10, M12x1, M14x1.
ISO7 (BSPT): R1/8, R1/4. ISO-228 (BSPP): G1/8, G1/4



- » Series HP6000 are used in centralized lubrication systems:
 - Manufacturing equipment
 - Construction machinery
 - Industrial automation
 - Transportation
 - Wind power generation
 - Maintenance, repair and overhaul
- » Tubing used:
 - Polyamide tube PA 12 HL - PA 12 PHL
 - High pressure hose with smooth grooved metal end

Series HP6000 is designed with a special collet that provides a long service life for lubrication and greasing systems for industrial and transportation applications. Thanks to its easy connection and disconnection capability, robust and compact design as well as the materials used in its construction, these quick-connect fittings are ideal for high pressures up to 150bar. The range is available with different threads (metric, ISO7 and ISO-228) and is suitable for use with rigid and semi-rigid tubes to meet different application needs.

GENERAL DATA

Temperature	- 30°C ÷ 80°C (see the technical data of tubing used)
Working pressure	0 ÷ 150 bar with oil and grease 0,9 ÷ 60 bar with air (see the technical data of tubing used) 3 ÷ 150 bar for VNR version (for upper pressure range contact our engineers)
Diameters	ø 4 - 6 mm
Threads	M5, M6x0,75, M6, M8x1, M10x1, M10, M12x1, M14x1. ISO7 (BSPT): R1/8, R1/4. ISO-228 (BSPP): G1/8, G1/4
Fluid	oil and grease for lubrication, compressed air
Tube to connect	Oil and grease: PA 12 HL - PA 12 PHL Rigid metal pipe with smooth grooved metal end (tolerance of PA tubing in compliance to ISO14743) Compressed air: Polyammide (PA) 6 - 11 - 12, Polyurethane (PU), Polyethylene (PE), Polyester hytrel
Materials	- standard models: body and collet in nickel-plated brass, O-Ring in NBR, thread seals in NBR - models with VNR: body and collet in nickel-plated brass, spring and ball in stainless steel, O-Ring in NBR

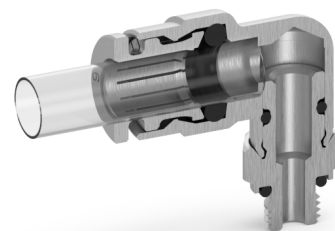

Fittings Mod. HP6512



Male Connector
Thread Metric parallel and BSPP ISO-228

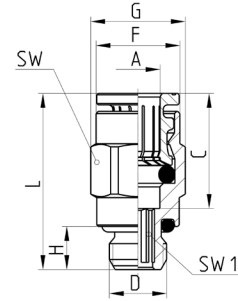

Mod.	A	D	C	F	G	H	L	SW	SW1	Weight (g)
HP6512 4-M5	4	M5x0,8	14	7,8	8,8	4	20	8	2	4
HP6512 4-M6	4	M6x1	14	8,8	9,9	4,5	20,5	9	2,5	6
HP6512 4-M8x1	4	M8x1	14	8,8	11,5	6	19	10	2,5	8
HP6512 4-M10x1	4	M10x1	14	8,8	13,5	6	19	12	2,5	10
HP6512 4-M12x1	4	M12x1	14	8,8	15,4	7	20	14	2,5	14
HP6512 4-1/8	4	G1/8	14	8,8	13,5	6	19	12	2,5	10
HP6512 4-1/4	4	G1/4	14	8,8	16,4	7	20,5	15	2,5	14
HP6512 6-M5	6	M5x0,8	16	11,7	13,2	4	22	12	2	8
HP6512 6-M6	6	M6x1	16	11,7	13,2	7	25	12	2,5	8
HP6512 6-M8x1	6	M8x1	16	11,7	13,2	6	24,5	12	4	8
HP6512 6-M10x1	6	M10x1	16	11,7	13,5	6	21	12	4	10
HP6512 6-M12x1	6	M12x1	16	11,7	15,4	7	22	14	4	13
HP6512 6-1/8	6	G1/8	16	11,7	13,5	6	21	12	4	10
HP6512 6-1/4	6	G1/4	16	11,7	16,4	7	22	15	4	13

Fittings Mod. HP6510



Male Connector
Thread Metric tapered and BSPT ISO-7

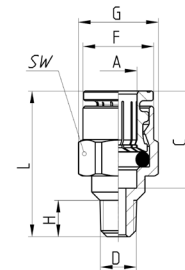

Mod.	A	D	C	F	G	H	L	SW	Weight (g)
HP6510 4-M6x0,75	4	M6x0,75	14	8,8	10,9	6	21	10	6
HP6510 4-M6	4	M6x1	14	8,8	10,9	6	21	10	6
HP6510 4-M8x1	4	M8x1	14	8,8	10,9	6	18	10	8
HP6510 4-M10x1	4	M10x1	14	8,8	13,2	6	18	12	10
HP6510 4-1/8	4	R1/8	14	8,8	13,2	7,5	18,5	12	10
HP6510 6-M6x0,75	6	M6x0,75	16	11,7	13,2	6	24	12	8
HP6510 6-M6	6	M6x1	16	11,7	13,2	6	24	12	8
HP6510 6-M8x1	6	M8x1	16	11,7	13,2	6	23,5	12	8
HP6510 6-M10x1	6	M10x1	16	11,7	13,2	6	21,5	12	10
HP6510 6-1/8	6	R1/8	16	11,7	13,2	7,5	22	12	10

Fittings Mod. HPR6512



Male Connector
Thread Metric parallel

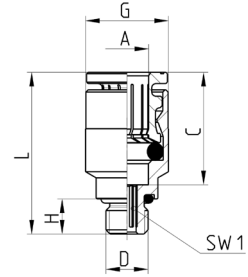

Mod.	A	D	C	G	H	L	SW1	Weight (g)
HPR6512 4-M5	4	M5x0,8	14	8,8	4	20	2	4
HPR6512 4-M6	4	M6x1	14	8,8	4,5	20,5	2,5	6
HPR6512 4-M6x0,75	4	M6x0,75	14	8,8	4,5	20,5	2,5	6
HPR6512 6-M5	6	M5x0,8	16	11,7	4	22	2	8
HPR6512 6-M6	6	M6x1	16	11,7	4,5	22,5	2,5	8
HPR6512 6-M6x0,75	6	M6x0,75	16	11,7	4,5	22,5	2,5	8

Fittings Mod. HP6500

Fixed Male Elbow
Thread Metric tapered and BSPT ISO-7

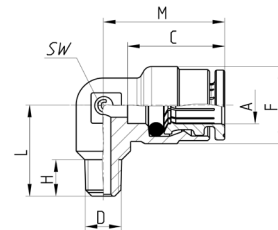

Mod.	A	D	C	F	H	L	M	SW	Weight (g)
HP6500 4-M6x0,75	4	M6x0,75	14	9	6	13,5	17,5	8	6
HP6500 4-M6	4	M6x1	14	9	6	13,5	17,5	8	6
HP6500 4-M8x1	4	M8x1	14	9	6	13,5	17,5	8	8
HP6500 4-M10x1	4	M10x1	14	9	6	13,5	17,5	8	10
HP6500 4-M10	4	M10	14	9	7,5	15	17,5	8	10
HP6500 4-M12x1	4	M12x1	14	10	7	15	19	10	15
HP6500 4-1/8	4	R1/8	14	9	7,5	15	17,5	8	10
HP6500 4-1/4	4	R1/4	14	10	11,5	19,5	19	10	15
HP6500 6-M6x0,75	6	M6x0,75	16	12,7	6	15	20	9	8
HP6500 6-M6	6	M6x1	16	12,7	6	15	20	9	8
HP6500 6-M8x1	6	M8x1	16	12,7	6,5	14	20	9	10
HP6500 6-M10x1	6	M10x1	16	12,7	6	14	20	9	11
HP6500 6-M10	6	M10	16	12,7	7	15,5	20	9	11
HP6500 6-M12x1	6	M12x1	16	12,7	7	14,5	20	9	11
HP6500 6-1/8	6	R1/8	16	12,7	7,5	15,5	20	9	11
HP6500 6-1/4	6	R1/4	16	12,7	12	19,5	20	9	11

Fittings Mod. HP6522

Swivel Male Elbow
Thread Metric parallel and BSPP ISO-228

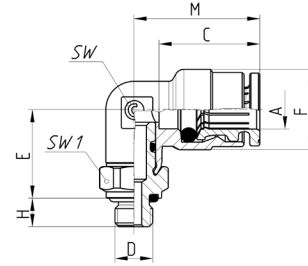

DIMENSIONS										
Mod.	A	D	C	E	F	H	M	SW	SW1	Weight (g)
HP6522 4-M5	4	M5x0,8	14	13	9	4	17,5	8	8	12
HP6522 4-M6	4	M6x1	14	13	9	4,5	17,5	8	9	14
HP6522 4-M6x0,75	4	M6x0,75	14	13	9	4,5	17,5	8	9	14
HP6522 4-M8x1	4	M8x1	14	14,5	9	6	17,5	8	10	15
HP6522 4-M10x1	4	M10x1	14	14,5	9	6	17,5	8	12	23
HP6522 4-1/8	4	G1/8	14	14,5	9	6	17,5	8	12	15
HP6522 4-1/4	4	G1/4	14	15,5	9	7	17,5	8	15	25
HP6522 6-M5	6	M5x0,8	16	13,5	12,7	4	20	9	10	14
HP6522 6-M6	6	M6x1	16	14	12,7	4,5	20	9	10	16
HP6522 6-M6x0,75	6	M6x0,75	16	14	12,7	4,5	20	9	10	16
HP6522 6-M8x1	6	M8x1	16	15	12,7	6	20	9	10	19
HP6522 6-M10x1	6	M10x1	16	15	12,7	6	20	9	12	25
HP6522 6-1/8	6	G1/8	16	15	12,7	6	20	9	12	19
HP6522 6-1/4	6	G1/4	16	15,9	12,7	7	20	9	15	29

Fittings Mod. HP6520

Swivel Male Elbow
Thread Metric tapered and BSPT ISO-7

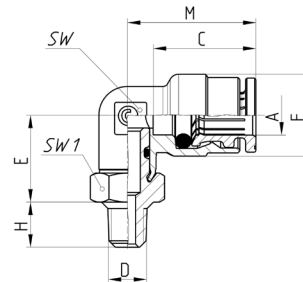

DIMENSIONS										
Mod.	A	D	C	E	F	H	M	SW	SW1	Weight (g)
HP6520 4-M6	4	M6x1	14	13	9	6	17,5	8	10	10
HP6520 4-M8x1	4	M8x1	14	14	9	6	17,5	8	10	12
HP6520 4-M10x1	4	M10x1	14	14	9	6	17,5	8	12	15
HP6520 4-M12x1	4	M12x1	14	14	9	6	17,5	8	14	20
HP6520 4-1/8	4	R1/8	14	13	9	7,5	17,5	8	12	15
HP6520 4-1/4	4	R1/4	14	13	9	11	17,5	8	14	25
HP6520 6-M6	6	M6x1	16	13,5	12,7	6	20	9	10	14
HP6520 6-M8x1	6	M8x1	16	14,5	12,7	6	20	9	10	17
HP6520 6-M10x1	6	M10x1	16	14,5	12,7	6	20	9	12	21
HP6520 6-M12x1	6	M12x1	16	14,5	12,7	6	20	9	14	23
HP6520 6-1/8	6	R1/8	16	13,5	12,7	7,5	20	9	12	21
HP6520 6-1/4	6	R1/4	16	13,5	12,7	11	20	9	14	28

Fittings Mod. HP6622



Swivel Single Banjo
Thread Metric parallel and BSPP ISO-228

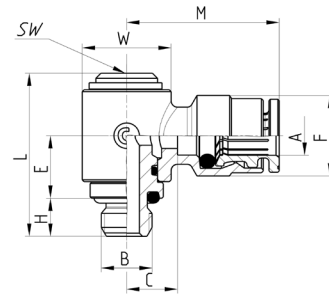

Mod.	A	B	C	E	F	H	L	M	SW	W	Weight (g)
HP6622 6-M6	6	M6x1	8	11,5	12,7	4,5	25,8	24	5	13,9	27
HP6622 6-M8x1	6	M8x1	8	9,75	12,7	6	25,7	24	5	13,9	29
HP6622 6-1/8	6	G1/8	8	9,75	12,7	6	25,7	24	5	13,9	32

Fittings Mod. HP6580



Union Connector

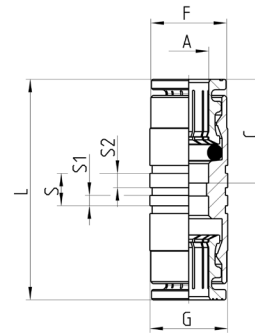

Mod.	A	C	F	G	L	S	S1	S2	Weight (g)
HP6580 4	4	14	8,4	9	29	5	1,6	2,2	14
HP6580 6	6	16	11,7	12	34	5	1,6	2,2	20

Fittings Mod. HP6590



Bulkhead Connector
Thread Metric parallel

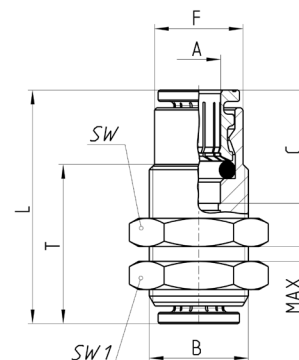

Mod.	A	B	C	F	L	MAX	SW	SW1	T	Weight (g)
HP6590 6	6	M14x1	16	12,5	33	2,12	17	17	22,5	34

Fittings Mod. HP6550

Elbow connector

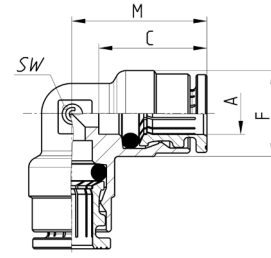

DIMENSIONS						
Mod.	A	C	F	M	SW	Weight (g)
HP6550 4	4	14	9	17,5	8	15
HP6550 6	6	16	12,7	20	9	21

Fittings Mod. HP6540

Tee Connector

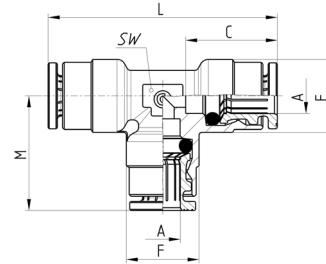

DIMENSIONS							
Mod.	A	C	F	L	M	SW	Weight (g)
HP6540 4	4	14	9	35	17,5	8	20
HP6540 6	6	16	12,7	40	20	9	30

Fittings Mod. HP6560

Y-shaped Connector

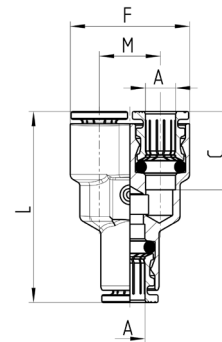

DIMENSIONS						
Mod.	A	C	F	L	M	Weight (g)
HP6560 6	6	16	24,4	39	12,5	34

Fittings Mod. HP6510 VNR



Male Connector
Thread Metric tapered and BSPT ISO-7

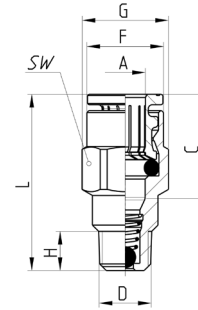

Mod.	A	D	C	F	G	H	L	SW	Weight (g)
HP6510 4-M8x1-VNR	4	M8x1	14	8,8	10,9	6	27,5	10	13,5
HP6510 4-M10x1-VNR	4	M10x1	14	8,8	11	6	27,5	10	17,5
HP6510 4-1/8-VNR	4	R1/8	14	8,8	11	7,5	27,5	10	17,5
HP6510 6-M8x1-VNR	6	M8x1	16	11,7	13,2	6	27	12	14,5
HP6510 6-M10x1-VNR	6	M10x1	16	11,7	13,2	6	27	12	16,5
HP6510 6-1/8-VNR	6	R1/8	16	11,7	13,2	7,5	27	12	16,5

Fittings Mod. HP6511 VNR



Male Connector
Thread Metric parallel

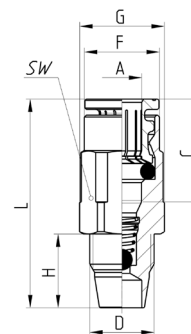

Mod.	A	D	C	F	G	H	L	SW	Weight (g)
HP6511 4-M10x1 VNR	4	M10x1	14	8,8	13,2	11,5	33	12	22
HP6511 6-M10x1 VNR	6	M10x1	16	11,7	13,2	11,5	32,5	12	19

Fittings Mod. HP6512 VNR



Male Connector
Thread Metric parallel and BSPP ISO-228

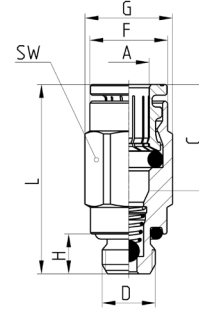

Mod.	A	D	C	F	G	H	L	SW	Weight (g)
HP6512 4-M8x1-VNR	4	M8x1	14	8,8	11,5	6	27,5	10	16
HP6512 4-M10x1-VNR	4	M10x1	14	8,8	11,5	6	27,5	10	18
HP6512 4-1/8-VNR	4	G1/8	14	8,8	11,5	6	27,5	10	18
HP6512 6-M8x1-VNR	6	M8x1	16	11,7	13,2	6	28,5	12	17
HP6512 6-M10x1-VNR	6	M10x1	16	11,7	13,5	6	27	12	21,5
HP6512 6-1/8-VNR	6	G1/8	16	11,7	13,5	6	27	12	21,5

Groove for metal pipe made by Camozzi grooving tool 8TRT (or machining)

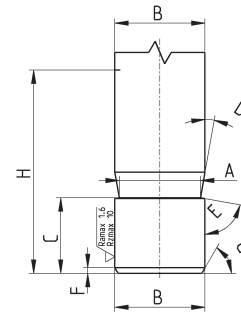

Code	A	B	C	D	E	F	G	H
-	3,4	4	5,3	10°	80°	0,5	45°	16,5
-	5,2	6	6,25	10°	80°	0,5	45°	18

Groove for metal pipe made by machining

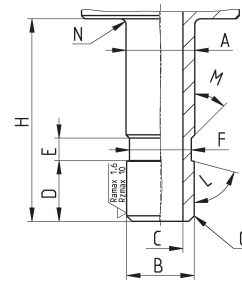

Code	A	B	C	D	E	F	G	H	L	M	N
-	4,1	4	2	5,3	2	3,5	0,5x45°	16,5	75°	45°	0,5
-	6,1	6	4	5,4	2	5,5	0,5x45°	18	75°	45°	0,5

Tube cutter tool Mod. PNZ... and PNZP-12

Tubes cutter Mod. PNZ...: replacement blades can be ordered separately.

Tubes cutter Mod. PNZP-12: plastic.



PNZ-...



PNZP-12

Mod.	
PNZ-12	able to cut tubes with Ø up to 12 mm
PNZ-25	able to cut tubes with Ø up to 25 mm
PNZP-12	able to cut tubes with Ø up to 12 mm

Grooving tool for metallic tubes

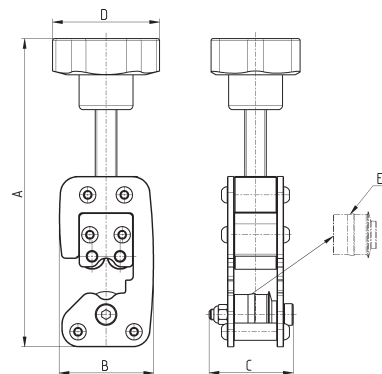

Mod.	Tube Ø	A (max)	B	C	D	Weight (g)	E (spare wheel)
8TRT 4	4	138	43.5	39	50	450	RTRT 4
8TRT 6	6	140	43.5	39	50	450	RTRT 6