

Cilindri in acciaio INOX Serie 97

Semplice e doppio effetto, ammortizzati, magnetici.
Ø 32, 40, 50, 63 mm

CILINDRI INOX SERIE 97



- » Design pulito
- » Acciaio inossidabile AISI 304
- » Ammortizzatore di fine corsa

I cilindri della Serie 97 possono essere utilizzati in applicazioni critiche per le quali è richiesta un'elevata resistenza alla corrosione (es. off-shore, navale, alimentare).

Questa serie di cilindri è normalmente fornita con ammortizzatori di fine corsa regolabili per mezzo di una vite posta sulla testata. Per rendere meno rumoroso l'impatto del pistone sulla testata, questi cilindri sono inoltre dotati di un ammortizzatore meccanico.

CARATTERISTICHE GENERALI

Costruzione	testate avvitate sul tubo con anello in Teflon intermedio
Funzionamento	semplice e doppio effetto
Materiali	testate, tubo e stelo in acciaio AISI 304 guarnizioni stelo in PU, guarnizione pistone in NBR elemento di guida in materiale plastico, grasso con certificazione NSF H1
Fissaggio	ghiera filettata anteriore e posteriore perni su testata anteriore cerniera maschio posteriore cerniera maschio posteriore snodata cerniera femmina posteriore
Corse min-max	25 ÷ 800 mm
Temperatura d'esercizio	0°C ÷ 80°C (con aria secca - 20°C)
Pressione d'esercizio	1 ÷ 10 bar
Velocità	10 ÷ 1000 mm/sec (senza carico)
Fluidi	Aria filtrata, senza lubrificazione. Nel caso si utilizzasse aria lubrificata, si consiglia olio ISO VG32 e di non interrompere mai la lubrificazione.

TABELLE CORSE STANDARD CILINDRI SERIE 97

- = Semplice effetto
 ✕ = Doppio effetto

CORSE STANDARD														
Ø	25	50	75	80	100	125	150	160	200	250	300	320	400	500
32	✕●	✕●	✕	✕	✕	✕	✕	✕	✕	✕	✕	✕	✕	✕
40	✕●	✕●	✕	✕	✕	✕	✕	✕	✕	✕	✕	✕	✕	✕
50	✕●	✕●	✕	✕	✕	✕	✕	✕	✕	✕	✕	✕	✕	✕
63	✕●	✕●	✕	✕	✕	✕	✕	✕	✕	✕	✕	✕	✕	✕

ESEMPIO DI CODIFICA

97	M	2	A	050	A	0200	
97	SERIE						
M	VERSIONI: M = cerniera maschio posteriore S = cerniera maschio snodata posteriore F = cerniera femmina posteriore T = testate ant. e post. filettate A = testata anteriore con perni						
2	FUNZIONAMENTO: 1 = semplice effetto, molla anteriore 2 = doppio effetto, ammortizzato anteriore e posteriore 6 = doppio effetto, stelo passante, ammortizzato anteriore e posteriore (solo versione T e A)				SIMBOLI PNEUMATICI: CS06 CD09 CD13		
A	CARATTERISTICHE MATERIALI: A = acciaio inossidabile AISI 304 - guarnizioni in PU V = acciaio inossidabile AISI 304 - guarnizioni in FKM (150°C)						
050	ALESAGGIO: 032 = 32 mm - 040 = 40 mm - 050 = 50 mm - 063 = 63 mm						
A	TIPO COSTRUTTIVO: A = standard con ghiera testata V e dado stelo U						
0200	CORSA (vedi tabella) = standard V = guarnizione stelo in FKM						

SIMBOLI PNEUMATICI

I simboli pneumatici indicati nell'ESEMPIO DI CODIFICA sono riportati di seguito.

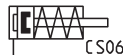
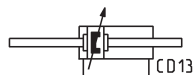
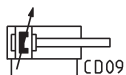

ACCESSORI CILINDRI INOX SERIE 97

CILINDRI INOX SERIE 97



Ancoraggio piedini / flangia Mod. B

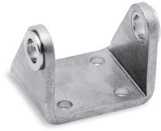

Ancoraggio a cerniera Mod. I

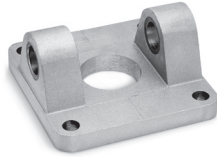

Ancoraggio a cerniera femmina post. Mod. C-H



Ancor. a cerniera femm. post. stretta Mod. CR



Ancor. a cern. masc. con snodo sferico Mod. R



Ancor. a cern. masc. 90° con snodo sf. Mod. ZCR

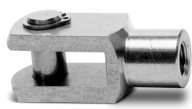

Forcella Mod. G-90



Snodo sferico stelo Mod. GA-90



Dado stelo Mod. U-90



Ghiera Mod. V-97



Spinotto Mod. S-90



Spinotto antirotazione Mod. SR-90



Tutti gli accessori sono forniti separatamente al cilindro, fatta eccezione del dado stelo Mod. U e della ghiera Mod. V

Cilindri Serie 97, Mod. T

Con testate anteriori e posteriori filettate



+ = sommare la corsa

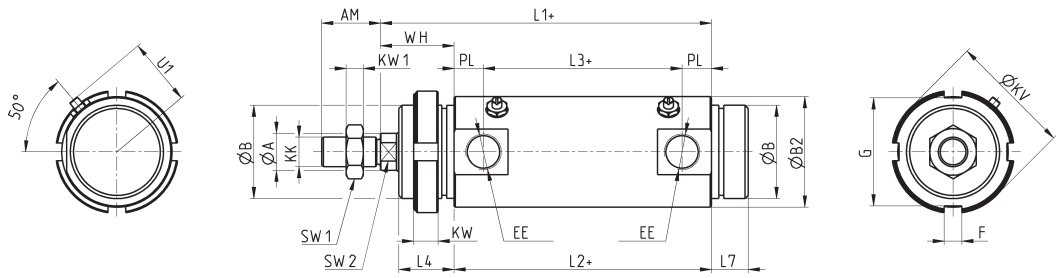

INGOMBRI																					
Ø	ØA	AM	ØB	ØB2	EE	F	G	KK	PL	SW1	KW1	SW2	U1	WH	L1+	L2+	L3+	L4	L7	KW	ØKV
32	12	22	M30x1.5	36	G1/8	5	38	M10x1.25	9	17	6	10	23	26	120	94	76	19.5	15	7	42
40	16	24	M38x1.5	45	G1/4	6	50	M12x1.25	12	19	7	13	27	30	135	105	81	22.5	15	8	55
50	20	32	M45x1.5	55	G1/4	6	53	M16x1.5	12	24	8	17	33	37	143	106	82	28	18	10	60
63	20	32	M45x1.5	68	G3/8	6	53	M16x1.5	13	24	8	17	40	37	158	121	95	28	18	10	60

Cilindri Serie 97, Mod. T - stelo passante

Con testate filettate



+ = sommare la corsa
1 volta
++ = sommare la corsa
2 volte

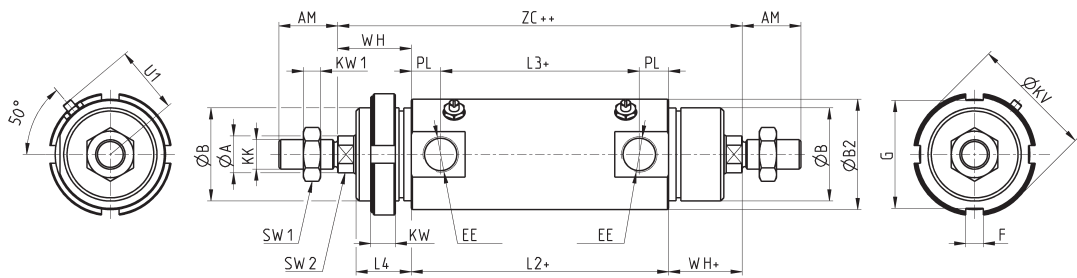

INGOMBRI																				
Ø	ØA	AM	ØB	ØB2	EE	F	G	KK	PL	SW1	KW1	SW2	U1	WH+	L2+	L3+	L4	KW	ØKV	ZC++
32	12	22	M30x1.5	36	G1/8	5	38	M10x1.25	9	17	6	10	23	26	94	76	19.5	7	42	146
40	16	24	M38x1.5	45	G1/4	6	50	M12x1.25	12	19	7	13	27	30	105	81	22.5	8	55	165
50	20	32	M45x1.5	55	G1/4	6	53	M16x1.5	12	24	8	17	33	37	106	82	28	10	60	180
63	20	32	M45x1.5	68	G3/8	6	53	M16x1.5	13	24	8	17	40	37	121	95	28	10	60	195

Cilindri Serie 97, Mod. M

Con cerniera maschio posteriore

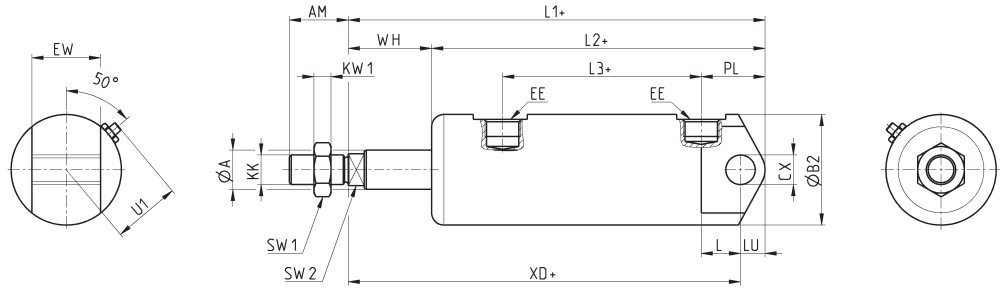

+ = sommare la corsa

INGOMBRI																			
Ø	ØA	AM	ØB2	CX	EE	EW	KK	PL	SW1	KW1	SW2	U1	WH	L1+	L2+	L3+	L	LU	XD+
32	12	22	36	10	G1/8	26	M10x1.25	23	17	6	10	23	26	151	125	76	13	9	142
40	16	24	45	12	G1/4	28	M12x1.25	26	19	7	13	27	34	170	136	81	16	10	160
50	20	32	55	12	G1/4	32	M16x1.5	32	24	8	17	33	37	182	145	82	16.5	12	170
63	20	32	68	16	G3/8	40	M16x1.5	29.5	24	8	17	40	50	202	152	95	21	12	190

Cilindri Serie 97, Mod. S

Con cerniera maschio snodata posteriore

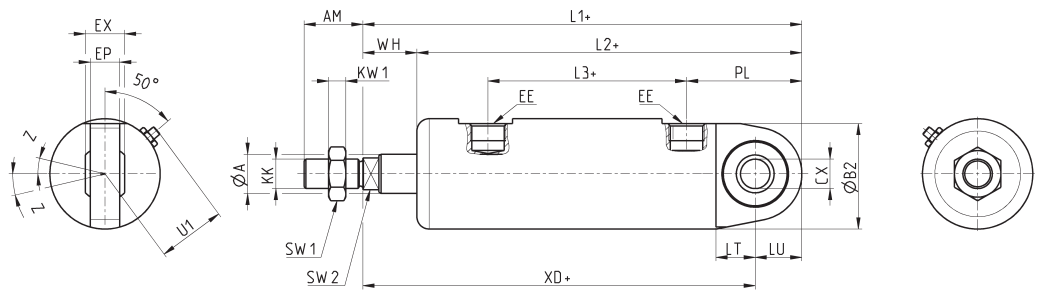

+ = sommare la corsa

INGOMBRI																					
Ø	ØA	AM	ØB2	CX	EE	EP	EX	KK	PL	SW1	KW1	SW2	U1	WH	L1+	L2+	L3+	LT	LU	XD+	Z
32	12	22	36	10	G1/8	10.5	14	M10x1.25	37	17	6	10	23	18	157	139	76	13	15	142	13
40	16	24	45	12	G1/4	12	16	M12x1.25	47	19	7	13	27	22	179	157	81	16	19	160	13
50	20	32	55	16	G1/4	15	21	M16x1.5	49	24	8	17	33	28.5	190.5	162	82	16.5	20.5	170	15
63	20	32	68	16	G3/8	15	21	M16x1.5	60	24	8	17	40	31.5	214	182.5	95	21	24	190	15

Cilindri Serie 97, Mod. F

Con cerniera femmina posteriore



+ = sommare la corsa

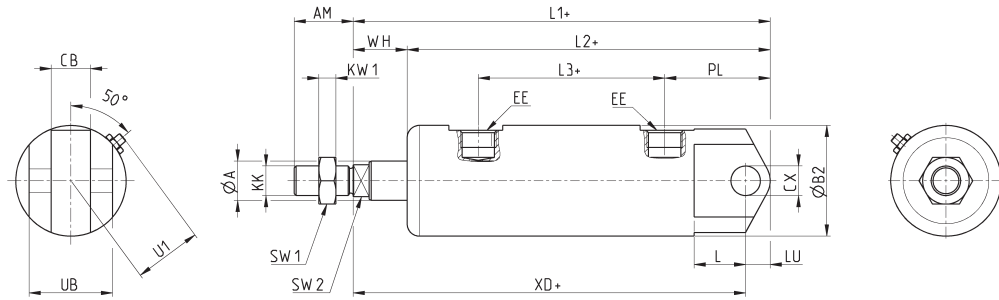

INGOMBRI																				
Ø	ØA	AM	ØB2	CB	CX	EE	KK	PL	SW1	KW1	SW2	U1	WH	L1+	L2+	L3+	L	LU	XD+	UB
32	12	22	36	14	10	G1/8	M10x1.25	31	17	6	10	23	18	151	133	76	13	9	142	34
40	16	24	45	16	12	G1/4	M12x1.25	38	19	7	13	27	22	170	148	81	16	10	160	40
50	20	32	55	21	16	G1/4	M16x1.5	45.5	24	8	17	33	28.5	182	153.5	82	21	12	170	45
63	20	32	68	21	16	G3/8	M16x1.5	48	24	8	17	40	31.5	202	170.5	95	21	12	190	51

Cilindri Serie 97, Mod. A

Con testata anteriore con perni



+ = sommare la corsa

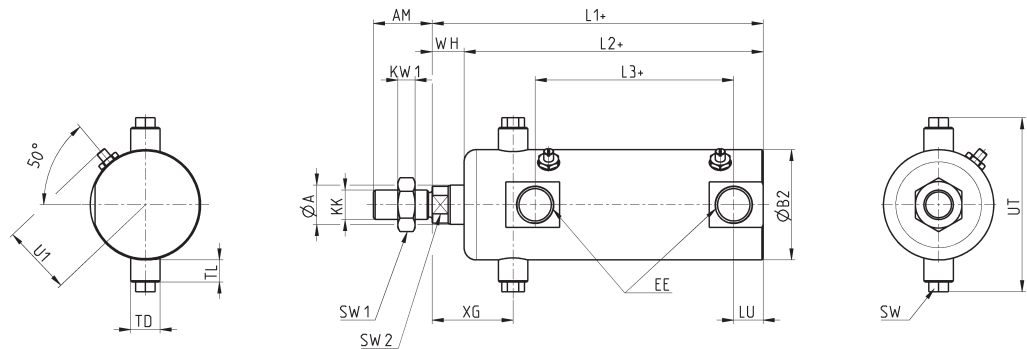

INGOMBRI																			
Ø	ØA	AM	ØB2	EE	KK	SW	SW1	KW1	SW2	U1	WH	L1+	L2+	L3+	LU	XG	TD	TL	UT
32	12	22	36	G1/8	M10x1.25	8	17	6	10	23	9	120	111	76	9	27	10	7	58
40	16	24	45	G1/4	M12x1.25	8	19	7	13	27	13	135	122	81	12	33	12	9	71
50	20	32	55	G1/4	M16x1.5	8	24	8	17	33	18	143	125	82	12	40	14	9	81
63	20	32	68	G3/8	M16x1.5	12	24	8	17	40	22.5	158	135.5	95	13	45	16	12	104

Ancoraggio piedini / flangia Mod. B



Materiale: Acciaio Inox 304

La fornitura comprende:
N° 1 ghiera
N° 2 piedini singoli

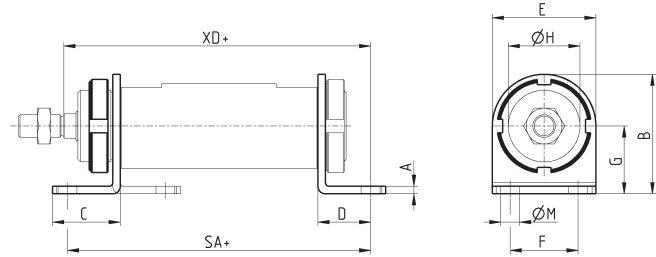

+ = sommare la corsa

INGOMBRI												
Mod.	Ø	A	B	C	D	E	SA+	F	G	ØH	ØM	XD+
B-97-32	32	4	53	35	24	42	142	32	32	30	7	142
B-97-40	40	4	63.5	36	28	55	161	36	36	38	10	160
B-97-50	50	5	77.5	47	32	65	170	45	45	45	10	170
B-97-63	63	5	82.5	45	32	65	185	50	50	45	10	190

Ancoraggio a cerniera Mod. I



Materiale: Acciaio Inox 304

La fornitura comprende:
N° 1 cerniera femmina
N° 2 boccole

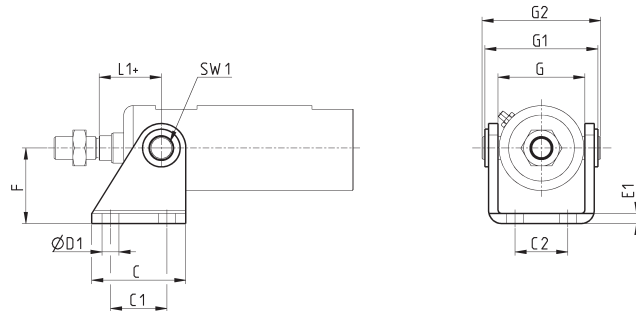

+ = sommare la corsa

INGOMBRI												
Mod.	Ø	C	C1	C2	ØD1	E1	F	G	G1	G2	L1+	SW1
I-97-32	32	40	24	20	7	4	35	38	50	58	27	8
I-97-40	40	50	30	28	9	5	40	46	60	71	33	8
I-97-50	50	54	34	36	9	6	45	57	74	81	40	8
I-97-63	63	65	35	43	9	6	50	70	88	104	45	12

Ancoraggio a cerniera femmina posteriore Mod. C-H

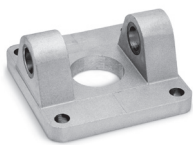

Materiale: Acciaio Inox 316

La fornitura comprende:
N° 1 cerniera femmina
N° 4 viti

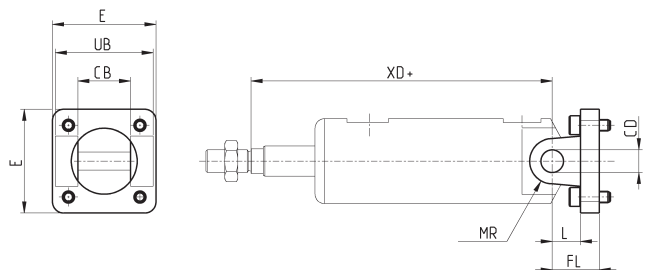

+ = sommare la corsa

INGOMBRI										
Mod.	Ø	CB	CD	E	FL	L	MR	UB	XD+	
C-H-90-32	32	26	10	45	22	12	10	45	142	
C-H-90-40	40	28	12	55	25	15	12	52	160	
C-H-90-50	50	32	12	65	27	17	12	60	170	
C-H-90-63	63	40	16	75	32	20	16	70	190	

Ancoraggio a cerniera femmina posteriore stretta Mod. CR



Materiale: Acciaio Inox 316

La fornitura comprende:
N° 1 cerniera femmina
N° 4 viti

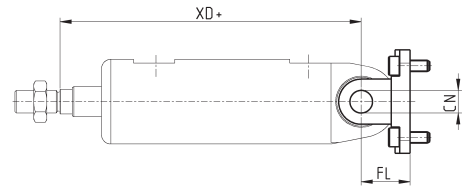
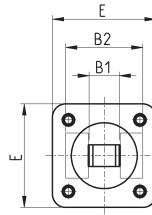

+ = sommare la corsa

DIMENSIONI							
Mod.	∅	B1	B2	E	CN	FL	XD+
CR-90-32	32	14	34	45	10	22	142
CR-90-40	40	16	40	55	12	25	160
CR-90-50	50	21	45	65	16	27	170
CR-90-63	63	21	51	75	16	32	190

Ancoraggio a cerniera maschio con snodo sferico Mod. R



Materiale: Acciaio Inox 316

La fornitura comprende:
N° 1 cerniera maschio
N° 4 viti

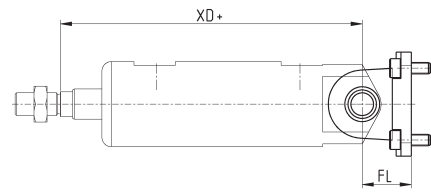
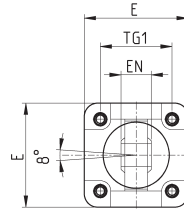

+ = sommare la corsa

INGOMBRI							
Mod.	∅	E	EN	FL	TG1	XD+	
R-90-32	32	45	14	22	32.5	142	
R-90-40	40	55	16	25	38	160	
R-90-50	50	65	21	27	46.5	170	
R-90-63	63	75	21	32	56.5	190	

Ancoraggio a cerniera maschio a 90° con snodo sferico Mod. ZCR



Materiale: Acciaio Inox 316

La fornitura comprende:
N° 1 cerniera maschio
N° 4 viti

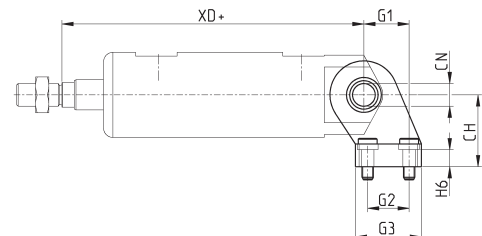
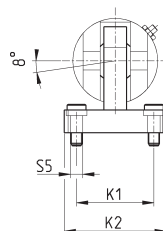

+ = sommare la corsa

INGOMBRI											
Mod.	∅	CH	CN	G1	G2	G3	H6	K1	K2	S5	XD+
ZCR-90-32	32	32	10	21	18	31	10	38	51	6.6	142
ZCR-90-40	40	36	12	24	22	35	10	41	54	6.6	160
ZCR-90-50	50	45	16	33	30	45	12	50	65	9	170
ZCR-90-63	63	50	16	37	35	50	12	52	67	14	190

Forcella Mod. G-90

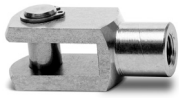

ISO 8140
Materiale: Acciaio Inox 303

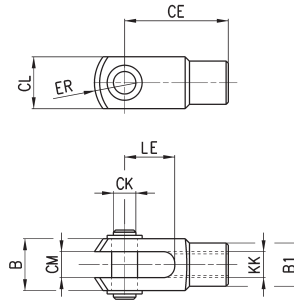

DIMENSIONI										
Mod.	∅	∅CK	LE	CM	CL	ER	CE	KK	B	∅B1
G-90-25-32	32	10	20	10	20	12	40	M10x1.25	26	18
G-90-40	40	12	24	12	24	14	48	M12x1.25	31	20
G-90-50-63	50-63	16	32	16	32	19	64	M16x1.5	39	26

Snodo sferico stelo Mod. GA-90



ISO 8139
Materiali:
- supporto in Acciaio INOX 304
- anello sferico in Acciaio INOX 420
- boccia in bronzo sinterizzato

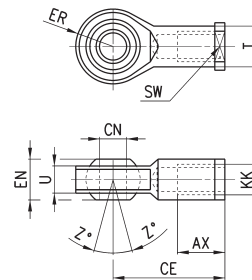

INGOMBRI											
Mod.	∅	∅CN	U	EN	ER	AX	CE	KK	∅T	Z	SW
GA-90-32	32	10	10.5	14	14	20	43	M10x1.25	15	6.5	17
GA-90-40	40	12	12	16	16	22	50	M12x1.25	17.5	6.5	19
GA-90-50-63	50-63	16	15	21	21	28	64	M16x1.5	22	7.5	22

Dado stelo Mod. U-90



UNI EN ISO 4035
Materiale: Acciaio Inox 304

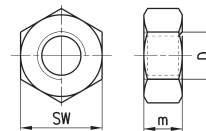

INGOMBRI				
Mod.	∅	D	m	SW
U-90-25-32	32	M10x1.25	6	17
U-90-40	40	M12x1.25	7	19
U-90-63	50-63	M16x1.5	8	24

Ghiera Mod. V-97



Materiale: acciaio Inox 304

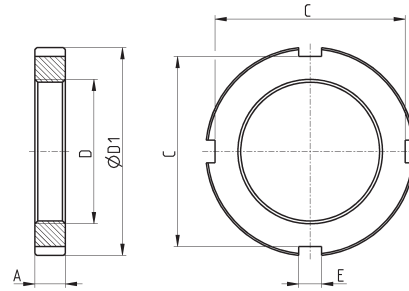

INGOMBRI							
Mod.	Ø	A	D	ØD1	E	C	
V-97-32	32	7	M30x1.5	42	5	38	
V-97-40	40	8	M38x1.5	55	6	50	
V-97-50-63	50-63	10	M45x1.5	60	6	53	

Spinotto Mod. S-90



La fornitura comprende:
N° 1 spinotto (acciaio Inox 303)
N° 2 seeger (acciaio)

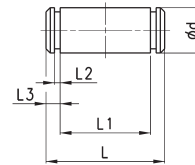

INGOMBRI							
Mod.	Ø	Ød	L	L1	L2	L3	
S-90-32	32	10	53	46	1.1	3	
S-90-40	40	12	60	53	1.1	3	
S-90-50	50	12	68	61	1.1	3	
S-90-63	63	16	78	71	1.1	3	

Spinotto antirotazione Mod. SR-90



La fornitura comprende:
N° 1 spinotto antirotazione
(acciaio Inox 316)
N° 1 seeger (acciaio)

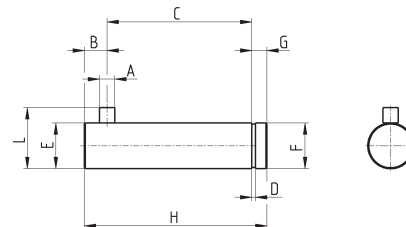

INGOMBRI											
Mod.	Ø	A	B	C	D	E	F	G	H	L	
SR-90-32	32	3	4.5	32.5	1.1	10	9.6	4	41	14	
SR-90-40	40	4	6	38	1.1	12	11.5	4	48	16	
SR-90-50	50	4	6	43	1.1	16	15.2	5	54	20	
SR-90-63	63	4	6	49	1.1	16	15.2	5	60	20	