

Pressure gauges

PRESSURE GAUGES



- » Radial connection
- » Rear connection
- » Panel mounting

To select the most suitable pressure gauge, the measurement range should be chosen considering the type of application according to the following criteria:

1. Constant pressure or pressure with slow fluctuations should be within 75% of the maximum scale value.
2. Pulsing pressure or rapid fluctuations should be within 65% of the maximum scale value.
3. Pressure peaks should never exceed the maximum scale value.

Miniature pressure gauge

New model

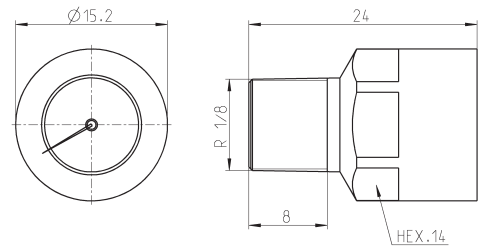

Mod.	Range
M015-P08	0 ÷ 8 bar

Pressure gauges for panel mounting

Precision class CL1,6

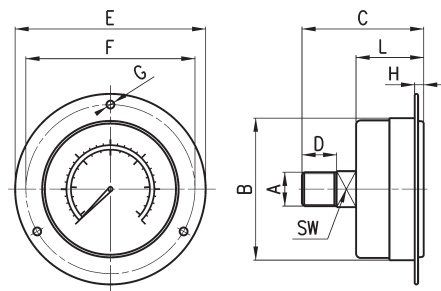

DIMENSIONS											
Mod.	A	B	C	D	E	F	G	H	L	SW	Range
M043-F04	R1/8	∅ 40.5	43	10	61	51	∅ 3.5	4	27	12	0-4 bar
M043-F06	R1/8	∅ 40.5	43	10	61	51	∅ 3.5	4	27	12	0-6 bar
M043-F10	R1/8	∅ 40.5	43	10	61	51	∅ 3.5	4	27	12	0-10 bar
M043-F12	R1/8	∅ 40.5	43	10	61	51	∅ 3.5	4	27	12	0-12 bar
M063-F12	R1/4	∅ 63	54	12	85	75	∅ 3.5	4.5	30.5	14	0-12 bar

Pressure gauges with radial connection

Precision class CL1,6

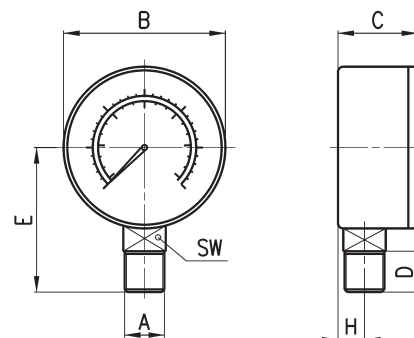

DIMENSIONS									
Mod.	A	B	C	D	E	H	SW	Range	
M043-R06	R1/8	∅ 38.8	24.2	10	35.2	9	12	0-6 bar	
M043-R12	R1/8	∅ 38.8	24.2	10	35.2	9	12	0-12 bar	
M053-R12	R1/8	∅ 48.8	27.5	10	43	10	14	0-12 bar	
M063-R12	R1/4	∅ 63	28.8	12	50	10	14	0-12 bar	

Pressure gauges with rear connection

Precision class CL1,6

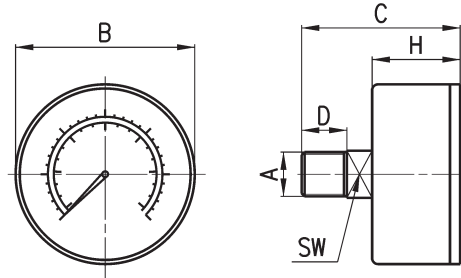

DIMENSIONS							
Mod.	A	B	C	D	H	SW	Range
M043-P02,5	R1/8	∅ 38.8	41	10	25	14	0 ÷ 2.5 bar
M043-P04	R1/8	∅ 38.8	41	10	25	14	0 ÷ 4 bar
M043-P06	R1/8	∅ 38.8	41	10	25	14	0 ÷ 6 bar
M043-P10	R1/8	∅ 38.8	41	10	25	14	0 ÷ 10 bar
M043-P12	R1/8	∅ 38.8	41	10	25	14	0 ÷ 12 bar
M053-P04	R1/8	∅ 50	41.5	10	25	14	0 ÷ 4 bar
M053-P06	R1/8	∅ 50	41.5	10	25	14	0 ÷ 6 bar
M053-P10	R1/8	∅ 50	41.5	10	25	14	0 ÷ 10 bar
M053-P12	R1/8	∅ 50	41.5	10	25	14	0 ÷ 12 bar
M063-P04	R1/4	∅ 63	40.5	12	25	14	0 ÷ 4 bar
M063-P06	R1/4	∅ 63	40.5	12	25	14	0 ÷ 6 bar
M063-P12	R1/4	∅ 63	40.5	12	25	14	0 ÷ 12 bar

Built-in pressure gauge

Precision class CL4,0

Supplied with:
1x pressure gauge
1x seal
2x screws

Fig. 1 = pressure gauge
Fig. 2 = seat

New model

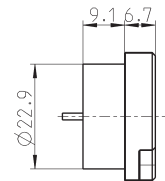
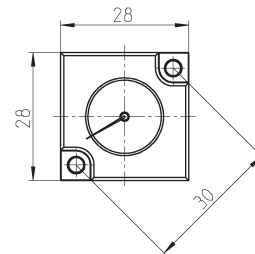

Fig. 1

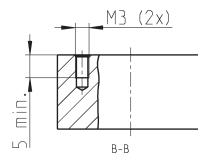
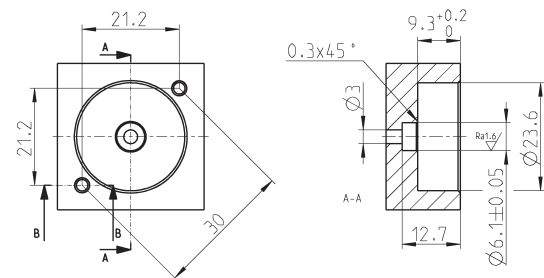

Fig. 2



Mod.	Range
MX3-R30/W-P	0 ÷ 12 bar
MX3-R31/W-P	0 ÷ 6 bar
MX3-R32/W-P	0 ÷ 10 bar
MX3-R33/W-P	0 ÷ 2.5 bar