

# Series 6E electromechanical cylinders

Sizes 32, 40, 50, 63, 80, 100

SERIES 6E ELECTROMECHANICAL CYLINDERS



The Series 6E cylinders are mechanical linear actuators with rod, in which the rotary movement, generated by a motor, is converted into a linear movement by means of a recirculating ball screw. Available in 6 sizes, the Series 6E has dimensions based on the ISO 15552 standard and it is therefore possible to use the mounting accessories of the pneumatic cylinders.

The cylinders are equipped with a magnet that makes it possible to use external magnetic proximity switches (Series CST and CSH), allowing operations like homing or extra-stroke readings to be performed. The Series 6E is equipped with specific interface kits, which make it possible to connect the motor, both in line and parallel. High precision and easy mounting make the Series 6E the ideal solution for different applications, especially for multi-position systems.

- » In compliance with the ISO 15552 standard
- » Multi-position system with transmission of the movement by means of a recirculating ball screw
- » Possibility to connect the motor in line or parallel
- » Large range of motor interfaces
- » Permanent pre-lubrication (maintenance free)
- » High positioning repeatability
- » Reduced axial backlash
- » Possibility to use magnetic sensors
- » Integrated anti-rotation system of the rod
- » IP40 / IP65
- » Wide range of fixing accessories
- » Compatible with Series 45 anti-rotation guide units

## GENERAL DATA

<b>Construction</b>	electromechanical cylinder with recirculating ball screw
<b>Design</b>	profile with thread rolling screws based on the ISO 15552 standard
<b>Operation</b>	multi-position actuator with high precision linear movement
<b>Sizes</b>	32, 40, 50, 63, 80, 100
<b>Strokes (min - max)</b>	100 ÷ 1500 mm
<b>Anti-rotation function</b>	with anti-friction pads in technopolymer
<b>Mounting</b>	front / rear flange, with feet, with front / rear / swivel trunnion
<b>Mounting motor</b>	in line and parallel
<b>Operating temperature</b>	0°C ÷ 50°C
<b>Storage temperature</b>	-20°C ÷ 80°C
<b>Protection class</b>	IP40 / IP65
<b>Lubrication</b>	Not necessary. A pre-lubrication is performed on the cylinder.
<b>Max. Reversing backlash</b>	0.02 mm
<b>Repeatability</b>	± 0.02
<b>Duty cycle</b>	100%
<b>Max rotation play</b>	± 0.4°
<b>Use with external sensors</b>	slots on three sides for sensors model CSH and CST

## STANDARD STROKES

Intermediate strokes are available upon request.

STANDARD STROKES											
Size	100	200	300	400	500	600	700	800	1000	1200	1500
32	x	x	x	x	x						
40	x	x	x	x	x	x	x				
50	x	x	x	x	x	x		x	x		
63	x	x	x	x	x			x	x	x	
80	x	x	x	x	x			x	x	x	x
100	x	x	x	x	x			x	x	x	x

## CODING EXAMPLE

<b>6E</b>	<b>032</b>	<b>BS</b>	<b>0200</b>	<b>P05</b>	<b>A</b>
<b>6E</b>	SERIES				
<b>032</b>	SIZE: 032 = 32 040 = 40 050 = 50 063 = 63 080 = 80 100 = 100				
<b>BS</b>	DESIGN: BS = recirculating ball screw				
<b>0200</b>	STROKE: 100 ÷ 1500 mm				
<b>P05</b>	SCREW PITCH: P05 = 5 mm P10 = 10 mm P16 = 16 mm (for size 40 only) P20 = 20 mm (for size 50 only) P25 = 25 mm (for size 63 only) P32 = 32 mm (for size 80 only) P40 = 40 mm (for size 100 only)				
<b>A</b>	CONSTRUCTION: A = standard with rod nut				
	VERSION: = IP40 (not available for sizes 80 and 100) P = IP65 ( _ _ _ ) = extended piston rod _ _ _ mm				

## MECHANICAL CHARACTERISTICS

Size	32	32	40	40	40	50	50	50	63	63	63	80	80	80	80	100	100	100	100
<b>BS screw diameter</b> [mm]	12	12	16	16	16	20	20	20	25	25	25	32	32	32	32	40	40	40	40
<b>BS screw pitch (p)</b> [mm]	5	10	5	10	16	5	10	20	5	10	25	5	10	20	32	5	10	20	40
<b>Dynamic load coefficient (C)</b> [N]	6600	4400	12000	8500	9150	14900	11300	7800	17700	20500	11300	26300	52500	28200	26100	35100	55900	45300	55900
<b>Max admissible load (C<sub>max</sub>)</b> [N]	525 <sup>(A)</sup>	440 <sup>(A)</sup>	950 <sup>(A)</sup>	850 <sup>(A)</sup>	1070 <sup>(A)</sup>	1180 <sup>(A)</sup>	1130 <sup>(A)</sup>	980 <sup>(A)</sup>	1405 <sup>(A)</sup>	2050 <sup>(A)</sup>	1535 <sup>(A)</sup>	2085 <sup>(A)</sup>	5250 <sup>(A)</sup>	3550 <sup>(A)</sup>	3845 <sup>(A)</sup>	2785 <sup>(A)</sup>	5590 <sup>(A)</sup>	5705 <sup>(A)</sup>	8875 <sup>(A)</sup>
<b>Max applicable torque</b> [Nm]	2.50	2.80	5.50	6.50	8.20	9.10	10.90	13.60	16.60	19.90	24.90	30	36	30	36	60	60	60	60
<b>Max linear speed</b> <sup>*</sup> [m/s]	0.56	1.12	0.42	0.84	1.33	0.33	0.67	1.33	0.27	0.53	1.33	0.23	0.47	0.94	1.50	0.19	0.38	0.75	1.50
<b>Max rotational speed</b> [rpm]	6670	6670	5000	5000	5000	4000	4000	4000	3200	3200	3200	2810	2810	2810	2810	2250	2250	2250	2250
<b>Max acceleration</b> [m/s <sup>2</sup> ]	25	25	25	25	25	25	25	25	25	25	25	25	25	25	25	25	25	25	25

<sup>(A)</sup> Value refers to a covered distance of 10000 Km (see the diagrams "Life of the cylinder according to the average axial force applied").

\* the maximum rotational speed of the cylinder varies according to the stroke (see the diagrams "Maximum speed of the cylinder according to its stroke")

**SERIES 6E MATERIALS**

SERIES 6E ELECTROMECHANICAL CYLINDERS

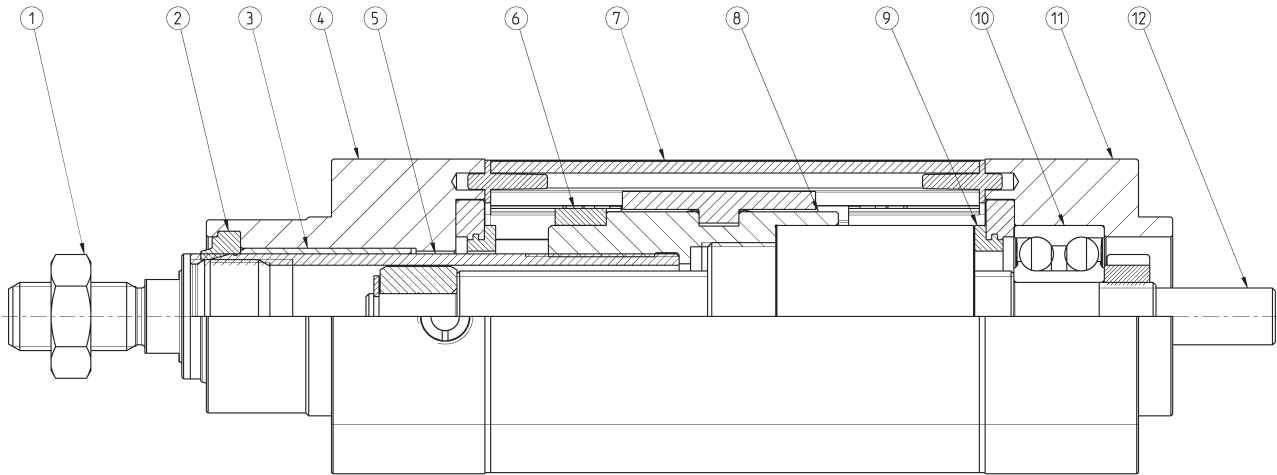

LIST OF COMPONENTS	
PARTS	MATERIALS
1. Rod nut	Zinc-plated steel
2. Rod seal	PU
3. Bushing	Technopolymer
4. Front endcap	Anodized aluminium alloy
5. Rod	Stainless steel
6. Magnet	Plastoferrite
7. Extrusion profile	Anodized aluminium alloy
8. Guiding element BS screw	Aluminium alloy
9. End stroke seals	NBR
10. Bearing	Steel
11. Rear endcap	Anodized aluminium alloy
12. BS ball screw	Steel

## ACCESSORIES FOR SERIES 6E CYLINDERS



Piston rod socket joint  
Mod. GY



Piston rod lock nut  
Mod. U



Clevis pin Mod. S

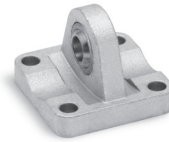

Rear trunnion ball-joint  
Mod. R

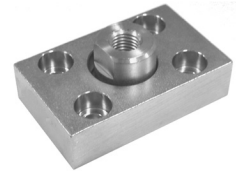

Coupling piece  
Mod. GKF



Swivel ball joint Mod. GA

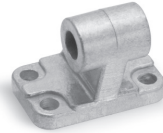

90° male trunnion  
Mod. ZC



Swivel Combination  
Mod. C+L+S

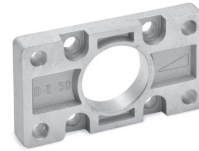

Front flange  
Mod. D-E



Self aligning rod  
Mod. GK



Foot mount Mod. B-6E

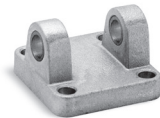

Rear female trunnion  
Mod. C and C-H

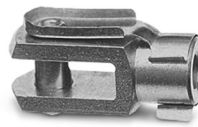

Rod fork end Mod. G

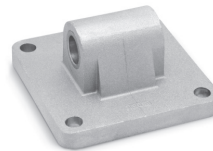

Rear trunnion male  
Mod. L



Side clamping bracket  
Mod. BG

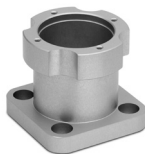

Housing for axial  
connection Mod. CM

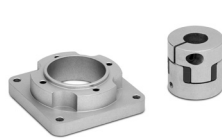

Flange for axial  
connection Mod. FM



Kit for axial connection  
Mod. AM



Kit for parallel connection  
Mod. PM

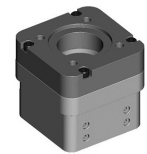

Kit for axial connection  
Mod. AR



Cylinder bracket  
Mod. BA-6E



Front spot faced trunnion  
Mod. FN



Counter bracket for  
trunnion Mod. BF



Series 45  
anti-rotation guide units



All accessories are supplied separately, except for piston rod lock nut Mod. U

## HOW TO CALCULATE THE LIFE OF THE CYLINDER

To perform a correct dimensioning of the Series 6E cylinder, you need to consider some facts.

Among these, the most important are:

- Dynamics of the system
- Operation and pause cyclicity
- Work environment
- General performance requirements: repeatability, accuracy, precision, etc.

### CALCULATE THE LIFE IN ROTATIONS

where:

$$L_r = \left( \frac{C}{F_m \cdot f_w} \right)^3 \cdot 10^6$$

$L_r$  = Life of the cylinder in number of rotations of the BS ball screw

$C$  = Dynamic load coefficient of the cylinder [N]

$F_m$  = Average axial force applied [N]

$f_w$  = Safety coefficient according to the working conditions

### CALCULATION OF LIFE IN km

where:

$$L_{km} = \frac{L_r \cdot p}{10^6}$$

$L_{km}$  = Life of the cylinder in km [km]

$p$  = pitch of the BS ball screw [mm]

### CALCULATION OF THE LIFE IN HOURS

where:

$$L_h = \frac{L_r}{n_m \cdot 60}$$

$L_h$  = Life of the cylinder in hours

$n_m$  = average number of revolutions of the RDS ball screw [rpm]

APPLICATION	ACCELERATION [ m/s <sup>2</sup> ]	SPEED [ m/s ]	DUTY CYCLE	$f_w$ COEFFICIENT
light	< 5.0	< 0.5	< 35%	1.0 ÷ 1.25
normal	5.0 ÷ 15.0	0.5 ÷ 1.0	35% ÷ 65%	1.25 ÷ 1.5
heavy	> 15.0	> 1.0	> 65%	1.5 ÷ 3.0

## ANALYSIS OF THE DUTY CYCLE AND OF SYSTEM PAUSES

The analysis of the duty cycle and of the pauses of the system is essential to calculate the average  $F_m$  axial loads and the number of average revolutions  $n_m$  that act on the cylinder.

Normally, the duty cycle is composed by phases and for each single phase, we can have an acceleration, constant speed or deceleration.

CALCULATION OF THE AVERAGE AXIAL FORCE

$$F_m = \sqrt[3]{\frac{(F_{a1}^3 \cdot n_{a1} \cdot t_{a1}) + (F_{vc1}^3 \cdot n_{vc1} \cdot t_{vc1}) + (F_{d1}^3 \cdot n_{d1} \cdot t_{d1}) + \dots + (F_{an}^3 \cdot n_{an} \cdot t_{an}) + (F_{vcn}^3 \cdot n_{vcn} \cdot t_{vcn}) + (F_{dn}^3 \cdot n_{dn} \cdot t_{dn})}{(n_{a1} \cdot t_{a1}) + (n_{vc1} \cdot t_{vc1}) + (n_{d1} \cdot t_{d1}) + \dots + (n_{an} \cdot t_{an}) + (n_{vcn} \cdot t_{vcn}) + (n_{dn} \cdot t_{dn})}}$$

CALCULATION OF THE AVERAGE NUMBER OF REVOLUTIONS

$$n_m = \left\{ \frac{(n_{a1} \cdot t_{a1}) + (n_{vc1} \cdot t_{vc1}) + (n_{d1} \cdot t_{d1}) + \dots + (n_{an} \cdot t_{an}) + (n_{vcn} \cdot t_{vcn}) + (n_{dn} \cdot t_{dn})}{t_{a1} + t_{vc1} + t_{d1} + \dots + t_{an} + t_{vcn} + t_{dn}} \right\}$$

The table shown below reports the values of acceleration, speed and deceleration for each phase.

		F [N]	n [rpm]	time %
PHASE 1	Acceleration	Fa1	na1	ta1
	Constant speed	Fvc1	nvc1	tvc1
	Deceleration	Fd1	nd1	td1
PHASE 2	Acceleration	Fa2	na2	ta2
	Constant speed	Fvc2	nvc2	tvc2
	Deceleration	Fd2	nd2	td2
PHASE "n -1"	Acceleration	Fan-1	nan-1	tan-1
	Constant speed	Fvcn-1	nvcn-1	tvcn-1
	Deceleration	Fdn-1	ndn-1	tdn-1
PHASE "n"	Acceleration	Fan	nan-1	tan-1
	Constant speed	Fvcn	nvcn-1	tvcn-1
	Deceleration	Fdn	ndn-1	tdn-1
<b>TOTAL</b>				<b>100%</b>

## APPLICATION EXAMPLE

Phase 1	$F_{a1} = 142 \text{ N};$ $n_{a1} = 630 \text{ rpm};$ $t_{a1} = 0,7 \text{ %};$	$F_{vc1} = 98 \text{ N};$ $n_{vc1} = 1260 \text{ rpm};$ $t_{vc1} = 12,9 \text{ %};$	$F_{d1} = 54 \text{ N};$ $n_{d1} = 630 \text{ rpm};$ $t_{d1} = 0,7 \text{ %};$
Phase 2	$F_{a2} = 616 \text{ N};$ $n_{a2} = 450 \text{ rpm};$ $t_{a2} = 4,8 \text{ %};$	$F_{vc2} = 589 \text{ N};$ $n_{vc2} = 900 \text{ rpm};$ $t_{vc2} = 33,3 \text{ %};$	$F_{d2} = 562 \text{ N};$ $n_{d2} = 450 \text{ rpm};$ $t_{d2} = 4,8 \text{ %};$
Phase 3	$F_{a3} = 997 \text{ N};$ $n_{a3} = 240 \text{ rpm};$ $t_{a3} = 7,1 \text{ %};$	$F_{vc3} = 981 \text{ N};$ $n_{vc3} = 480 \text{ rpm};$ $t_{vc3} = 28,6 \text{ %};$	$F_{d3} = 965 \text{ N};$ $n_{d3} = 240 \text{ rpm};$ $t_{d3} = 7,1 \text{ %};$

in this way it is possible to determine:

$$\begin{aligned} K_1 &= (F_{a1}^3 \cdot n_{a1} \cdot t_{a1}) + (F_{vc1}^3 \cdot n_{vc1} \cdot t_{vc1}) + (F_{d1}^3 \cdot n_{d1} \cdot t_{d1}) & n_1 &= (n_{a1} \cdot t_{a1}) + (n_{vc1} \cdot t_{vc1}) + (n_{d1} \cdot t_{d1}) & T_1 &= t_{a1} + t_{vc1} + t_{d1} \\ K_2 &= (F_{a2}^3 \cdot n_{a2} \cdot t_{a2}) + (F_{vc2}^3 \cdot n_{vc2} \cdot t_{vc2}) + (F_{d2}^3 \cdot n_{d2} \cdot t_{d2}) & n_2 &= (n_{a2} \cdot t_{a2}) + (n_{vc2} \cdot t_{vc2}) + (n_{d2} \cdot t_{d2}) & T_2 &= t_{a2} + t_{vc2} + t_{d2} \\ K_3 &= (F_{a3}^3 \cdot n_{a3} \cdot t_{a3}) + (F_{vc3}^3 \cdot n_{vc3} \cdot t_{vc3}) + (F_{d3}^3 \cdot n_{d3} \cdot t_{d3}) & n_3 &= (n_{a3} \cdot t_{a3}) + (n_{vc3} \cdot t_{vc3}) + (n_{d3} \cdot t_{d3}) & T_3 &= t_{a3} + t_{vc3} + t_{d3} \end{aligned}$$

Concluding, we know that:

$$F_m = \sqrt[3]{\frac{(K_1 + K_2 + K_3)}{(n_1 + n_2 + n_3)}} = 596,64 \text{ N}$$

$$n_m = \frac{n_1 + n_2 + n_3}{T_1 + T_2 + T_3} = 685,7 \text{ rpm}$$

		F [N]	n [rpm]	time %
PHASE 1	Acceleration	142	630	0.7
	Constant speed	98	1260	12.9
	Deceleration	54	630	0.7
PHASE 2	Acceleration	616	450	4.8
	Constant speed	589	900	33.3
	Deceleration	562	450	4.8
PHASE 3	Acceleration	997	240	7.1
	Constant speed	981	480	28.6
	Deceleration	965	240	7.1
<b>TOTAL</b>				<b>100.0</b>

## HOW TO CALCULATE THE DRIVING TORQUE [Nm]

$F_A$  = Total force acting from outside [N]  
 $F_E$  = Force to be applied externally [N]  
 $g$  = Gravitational acceleration (9.81 m/s<sup>2</sup>)  
 $m_E$  = Mass of the body to move [kg]  
 $\mu$  = Friction coefficient of the support guide  
 $p$  = Pitch of the ball screw [mm]  
 $C_{M1}$  = Driving torque due to external agents [Nm]

$$C_{TOT} = C_{M1} + C_{M2} + C_{M3}$$

$$F_A = F_E + \mu \cdot m_E \cdot g$$

$$C_{M1} = \frac{F_A \cdot p}{2\pi \cdot 1000}$$

$J_{TOT}$  = Moment of inertia of rotating components [kg·m<sup>2</sup>]  
 $J_F$  = Moment of inertia of fixed-length rotating components [kg·m<sup>2</sup>]  
 $J_V$  = Moment of inertia of variable-length rotating components [kg·m<sup>2</sup>]  
 $K_V$  = Coefficient of inertia of variable-length rotating components [kg·mm<sup>2</sup>/mm]  
 $C$  = Rod stroke [mm]  
 $\dot{\omega}$  = Angular acceleration [rad/s<sup>2</sup>]  
 $a$  = Linear acceleration of the ball screw [m/s<sup>2</sup>]  
 $C_{M2}$  = Driving torque due to rotating components [Nm]

$$J_{TOT} = (J_F + J_V) \cdot 10^{-6}$$

$$J_V = K_V \cdot C$$

$$\dot{\omega} = \frac{a \cdot 2\pi \cdot 1000}{p}$$

$$C_{M2} = J_{TOT} \cdot \dot{\omega}$$

$F_{TT}$  = Force needed to move translating components [N]  
 $F_{TF}$  = Force needed to move fixed-length translating components [N]  
 $F_{TV}$  = Force needed to move variable-length translating components [N]  
 $m_{c1}$  = Mass of the fixed-length translating components [kg]  
 $K_{TV}$  = Mass coefficient of variable-length translating components [kg/mm]  
 $C_{M3}$  = Driving torque due to translating components [Nm]

$$F_{TT} = F_{TF} + F_{TV}$$

$$F_{TF} = m_{c1} \cdot a$$

$$F_{TV} = K_{TV} \cdot C \cdot a$$

$$C_{M3} = \frac{F_{TT} \cdot p}{2\pi \cdot 1000}$$

Values of masses and fixed and rotating inertia moments of 6E components

Size	$J_f$ [ kg·mm <sup>2</sup> ]	$K_v$ [ kg·mm <sup>2</sup> /mm ]	$m_{c1}$ [ kg ]	$K_{TV}$ [ kg/m ]
32	2.88	0.02	0.15	0.79
40	7.92	0.05	0.43	0.98
50	21.77	0.12	0.70	1.13
63	66.35	0.30	1.07	1.38
80	230.89	0.81	2.25	1.87
100	526.49	1.98	3.94	2.37

### Life of the cylinder according to the average axial force applied

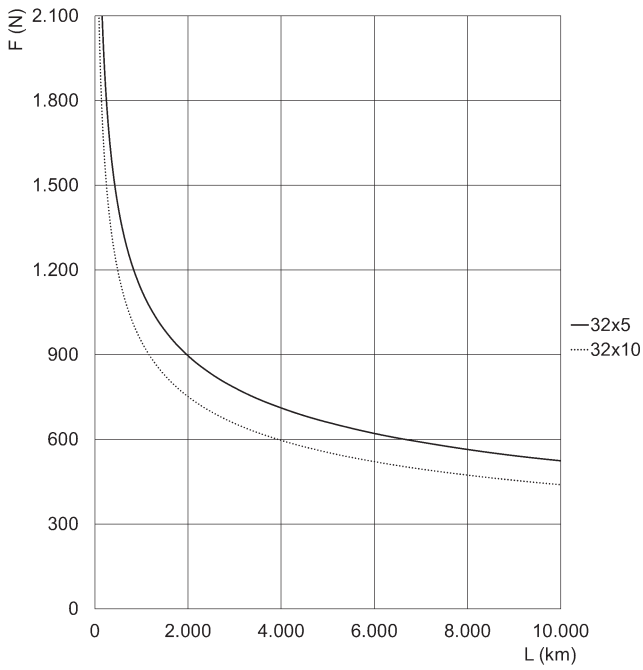

Size 32

F = Axial Force [N]  
L = life [km]

\* Curves calculated with  $f_w = 1$

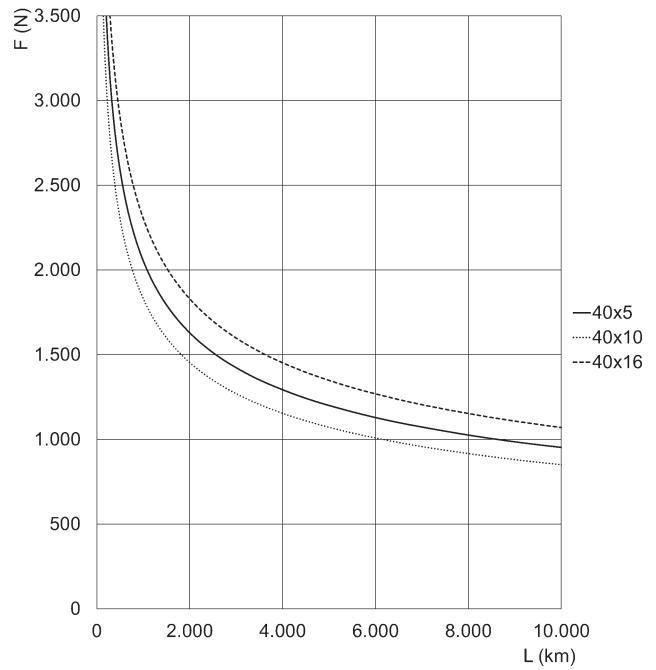

Size 40

F = Axial Force [N]  
L = life [km]

\* Curves calculated with  $f_w = 1$

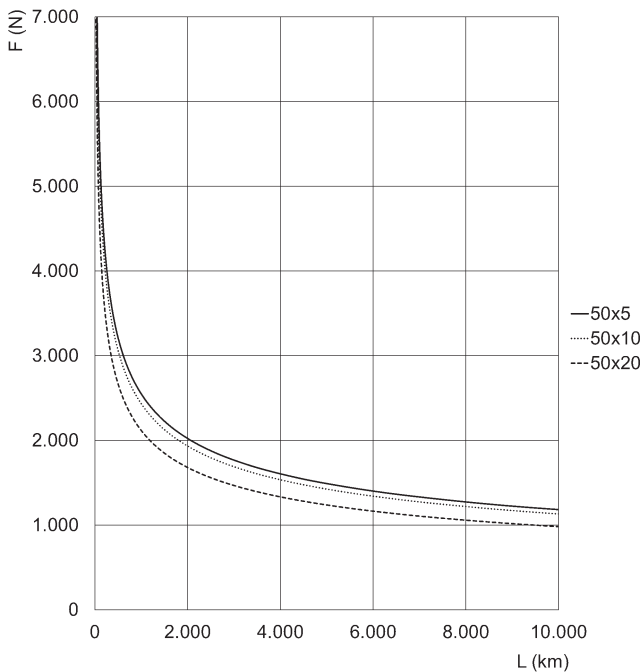

Size 50

F = Axial Force [N]  
L = life [km]

\* Curves calculated with  $f_w = 1$

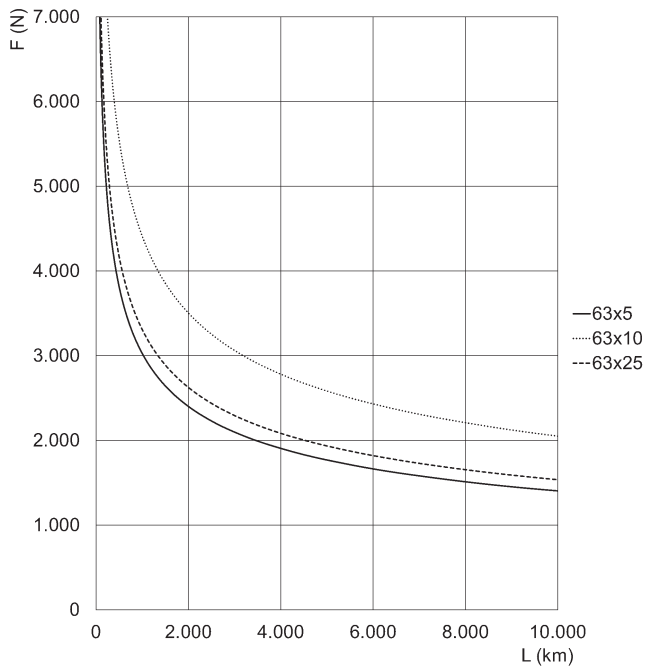

Size 63

F = Axial Force [N]  
L = life [km]

\* Curves calculated with  $f_w = 1$



**Life of the cylinder according to the average axial force applied**

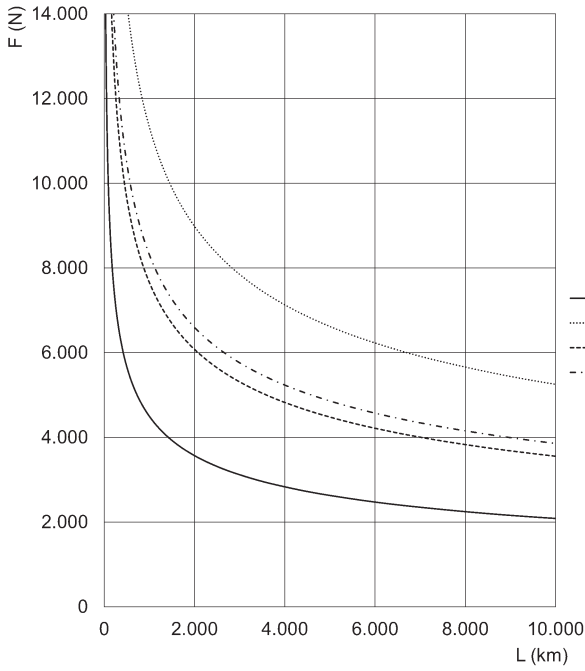

Size 80

F = Axial Force [N]  
L = life [km]

\* Curves calculated with  $f_w = 1$

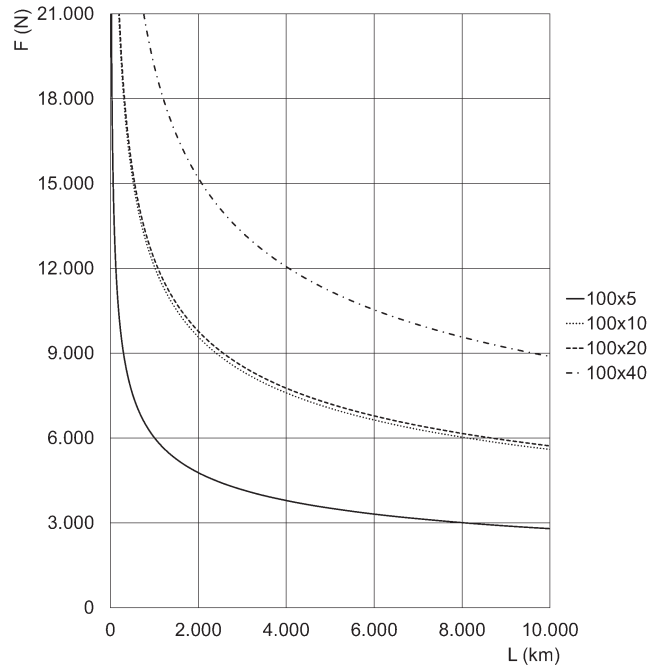

Size 100

F = Axial Force [N]  
L = life [km]

\* Curves calculated with  $f_w = 1$

**Maximum speed of the cylinder according to its stroke**

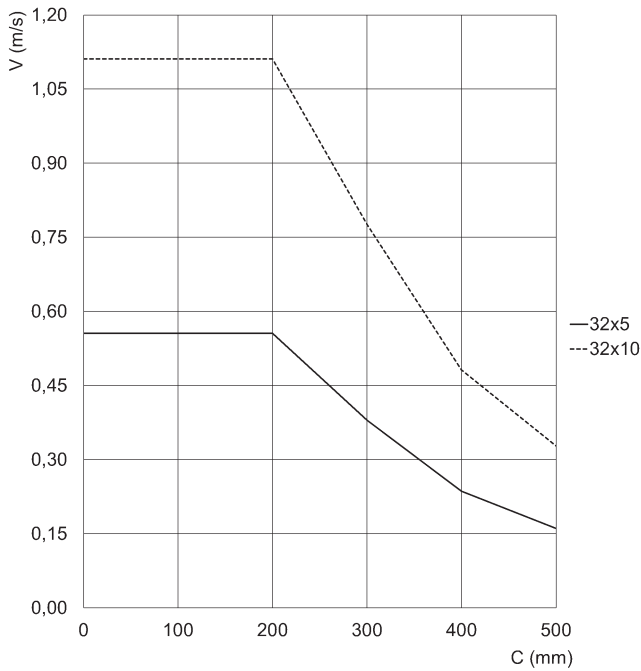

Size 32

V = speed [m/s]  
c = stroke [mm]

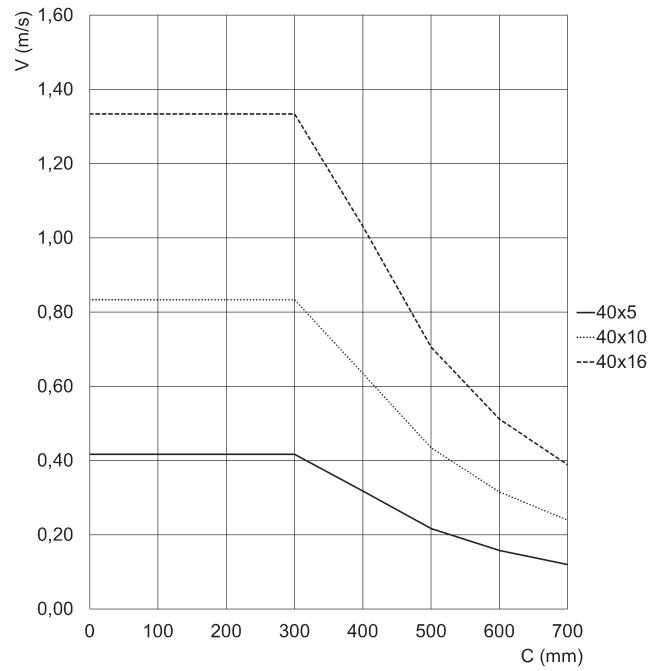

Size 40

V = speed [m/s]  
c = stroke [mm]

### Maximum speed of the cylinder according to its stroke

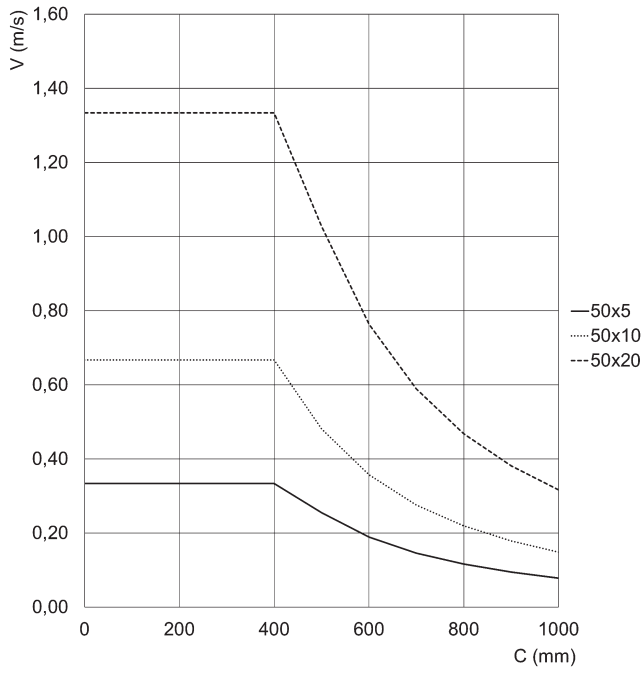

Size v

V = speed [m/s]  
c = stroke [mm]

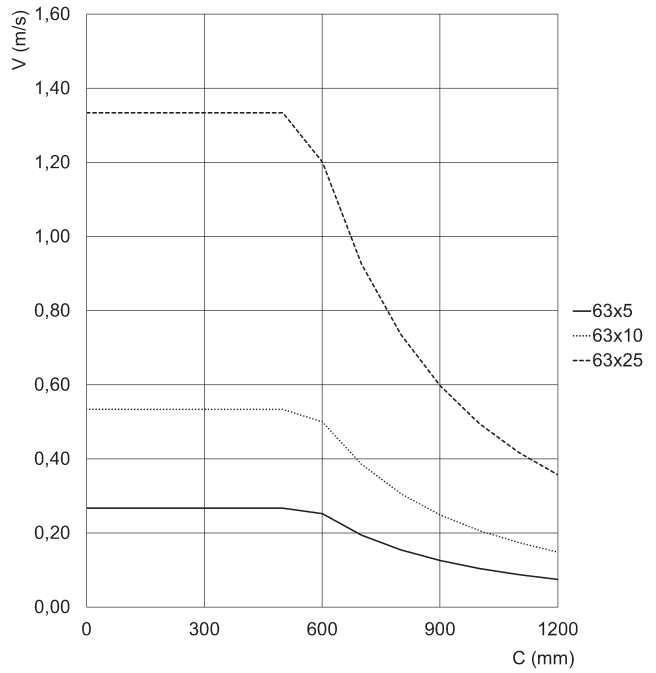

Size 63

V = speed [m/s]  
c = stroke [mm]

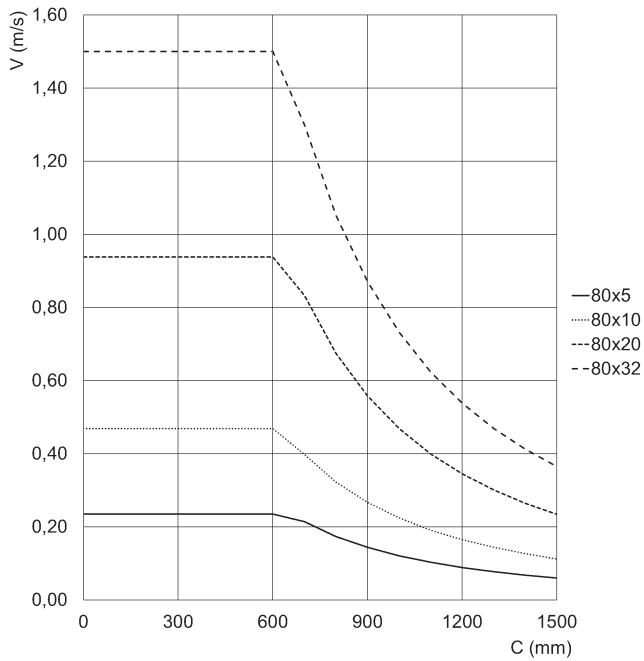

Size 80

V = speed [m/s]  
c = stroke [mm]

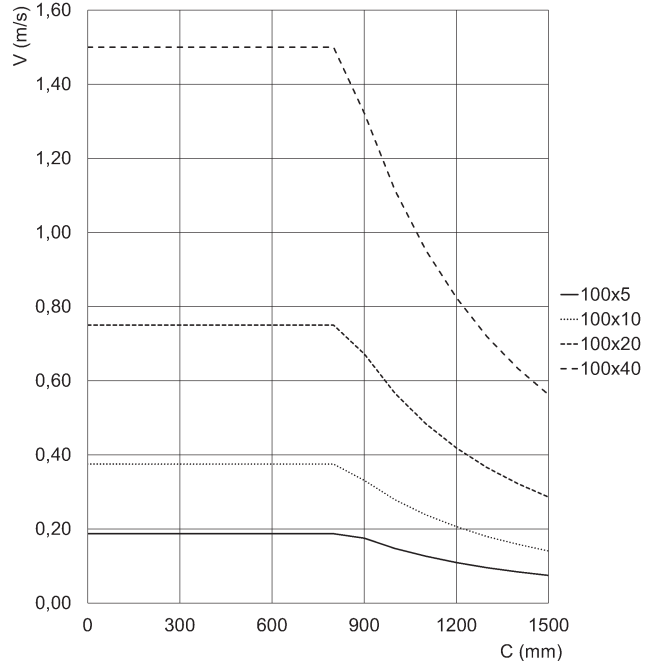

Size 100

V = speed [m/s]  
c = stroke [mm]

**Maximum force of the cylinder according to its stroke**

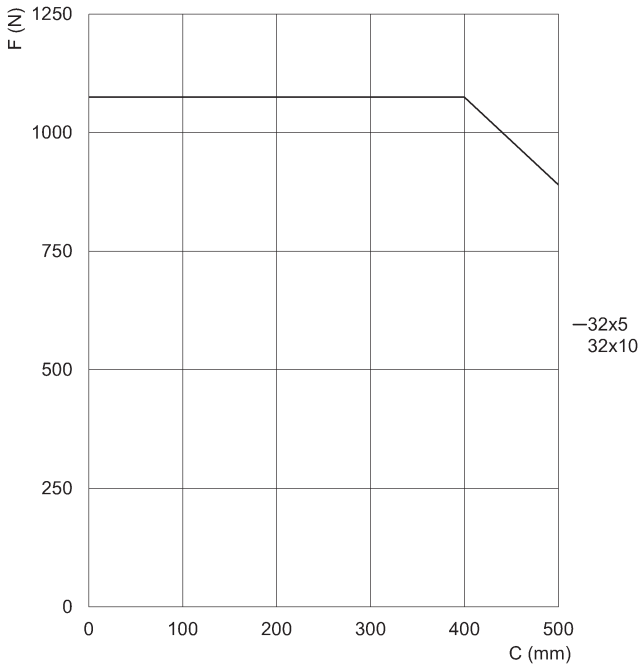

Size 32

F = static axial Force [N]  
c = stroke [mm]

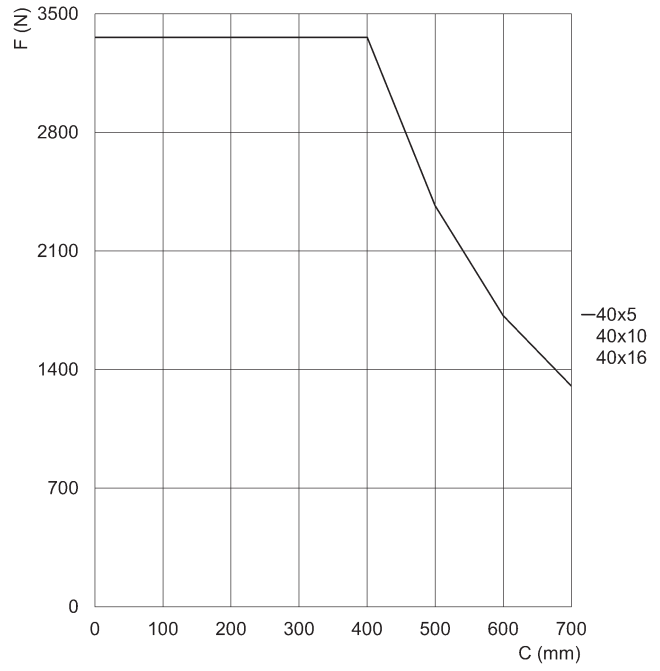

Size 40

F = static axial Force [N]  
c = stroke [mm]

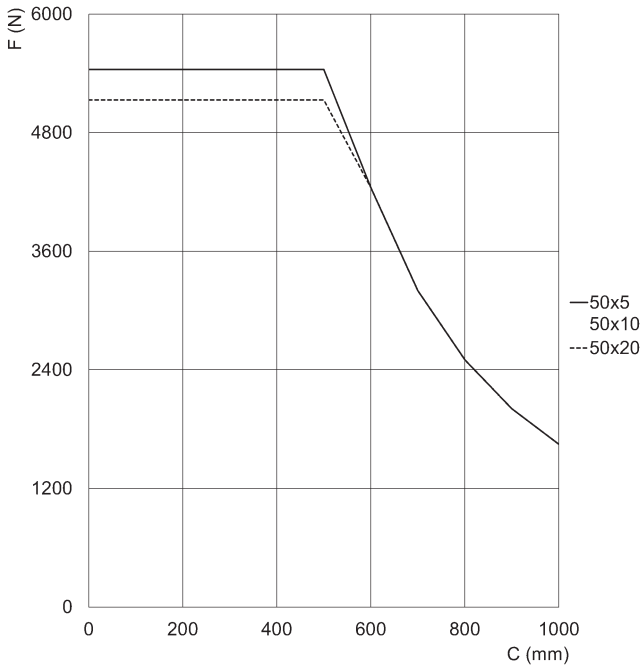

Size 50

F = static axial Force [N]  
c = stroke [mm]

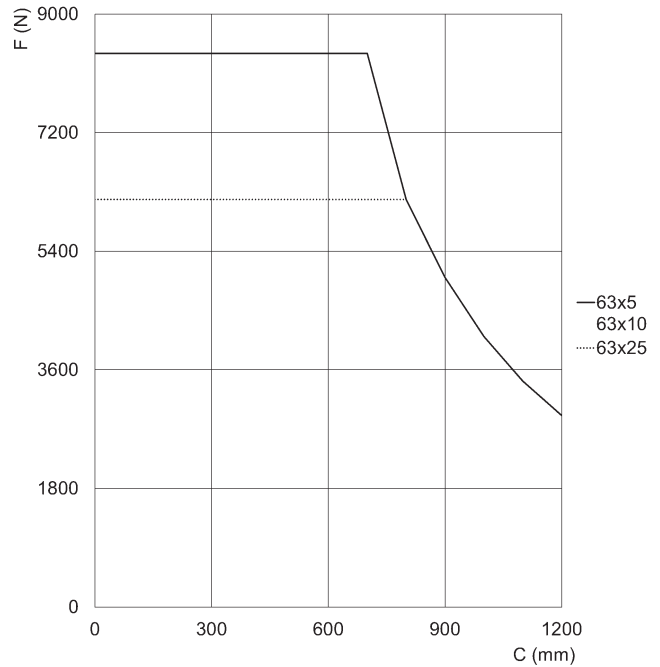

Size 63

F = static axial Force [N]  
c = stroke [mm]

Maximum force of the cylinder according to its stroke

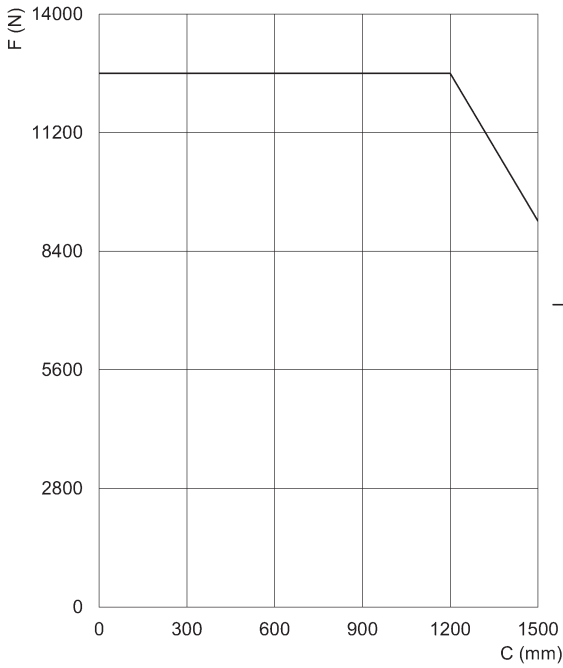

Size 80

F = static axial Force [N]  
c = stroke [mm]

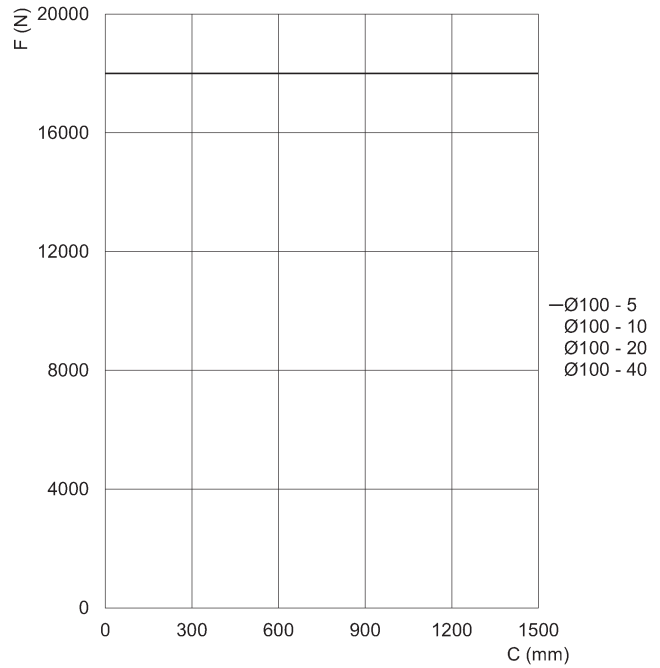

Size 100

F = static axial Force [N]  
c = stroke [mm]

SERIES 6E ELECTROMECHANICAL CYLINDERS

Series 6E cylinders

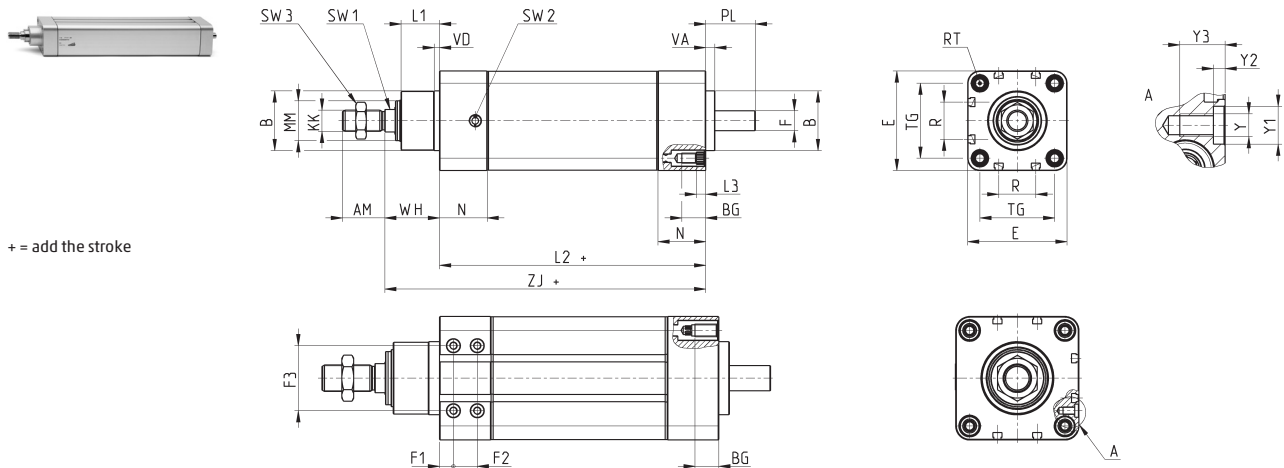

+ = add the stroke

Size	AM	B	BG	E	F	F1	F2	F3	KK	L1	L2+	L3	MM	N	R	RT	PL	SW1	SW2	SW3	TG	VA	VD	Y	Y1	Y2	Y3	WH	ZJ+	weight stroke 0 [g]	weight stroke [kg/m]
32	22	30	16	46.5	8	-	-	-	M10x1.25	20	125	5.5	18	26	13	M6	21	10	G1/8	17	32.5	6	4	-	-	-	30	155	1175	3.77	
40	24	35	16	55.4	10	-	-	-	M12x1.25	22	142	5.5	22	27	13.5	M6	24	13	G1/8	19	38	6	4	-	-	-	33	175	1395	5.30	
50	32	40	16	64.9	12	-	-	-	M16x1.5	26	173	5.5	25	36	16	M8	30	17	G1/8	24	46.5	7	4	-	-	-	38	211	2280	6.03	
63	32	45	16	75	15	-	-	-	M16x1.5	29	201	5.5	30	36	28	M8	38	17	G1/8	24	56.5	7	4	-	-	-	42	242.5	3500	9.77	
80	40	55	18	93	19	10.5	18	49	M20x1.5	35	211	-	40	39	30	M10	39	22	G1/4	30	72	8	8	M6	10	3	12	49	260	6440	13.70
100	40	65	18	115	24	13	18	62	M20x1.5	38	232	-	50	44	40	M10	42	22	G1/4	30	89	8	8	M8	12	3	16	51	283	10725	20.50

## Housing for axial connection Mod. CM

Material: anodized aluminium



Supplied with:  
1x housing  
4x screws

+ = add the stroke

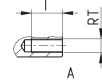
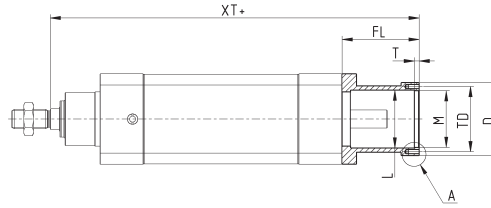
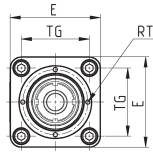

Mod.	Size	XT	E	$\varnothing D$	TG	FL	$\varnothing L$	$\varnothing M^{(H7)}$	T	TD	RT	I	Weight (g)
CM-6E-32	32	201	46.5	42	32.5	46	29	32	4	37	M3	9	100
CM-6E-40	40	224	55.4	52	38	49	36	37	4	43	M3	9	150
CM-6E-50	50	267	64.9	58	46.5	56	39	42	4	49	M4	9	225
CM-6E-63	63	306.5	75	60.5	56.5	64	48	47	4	54	M4	9	280

## Flange for axial connection Mod. FM

Material: anodized aluminium



Supplied with:  
1x flange  
1x flexible coupling  
4x screws

+ = add the stroke

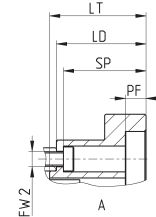
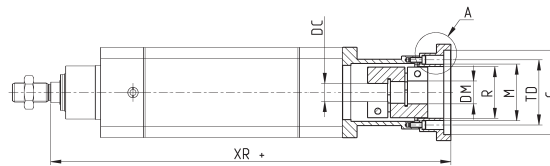
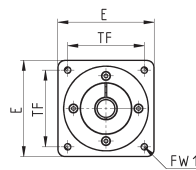

Mod.	Size	Housing	Motor	XR	$\varnothing C^{(H7)}$	PF	LT	LD	$\varnothing M^{(H7)}$	E	$\varnothing R$	TF	FW1	$\varnothing TD$	SP	$\varnothing FW2$	$\varnothing DC$	$\varnothing DM$	Weight (g)
FM-6E-32-0100	32	CM-6E-32	MTB-010-...	210	30	6	11	9	32	42	29	31.8	M3	37	6	3.5	8	8	65
FM-6E-32-0023	32	CM-6E-32	MTS-23-...	208	38.1	5	9	7	32	56.4	29	47.1	M4	37	5	3.5	8	6.35	140
FM-6E-40-0400	40	CM-6E-40	MTB-040-...	242	50	3.5	20	18	37	60	33	49.5	M5	43	3.5	3.5	10	14	140
FM-6E-40-0023	40	CM-6E-40	MTS-23-...	231	38.1	5	9	7	37	56.4	33	47.1	M4	43	5	3.5	10	6.35	215
FM-6E-50-0400	50	CM-6E-50	MTB-040-...	284	50	6	19	17	42	60	37	49.5	M5	49	14	4.5	12	14	210
FM-6E-50-0024	50	CM-6E-50	MTS-24-...	274	38.1	3	9	7	42	58	37	47.1	M4	49	4	4.5	12	8	190
FM-6E-63-0750	63	CM-6E-63	MTB-075-...	332.5	70	6	28	26	47	80	43	63.6	M6	54	24	4.5	15	19	565
FM-6E-63-0024	63	CM-6E-63	MTS-24-...	313.5	38.1	5	9	7	47	60.5	43	47.1	M4	54	5	4.5	15	8	200

## Kit for axial connection Mod. AM

Detailed information about the size of interfaceable motors can be found further on in the dedicated section.



Supplied with:  
1x housing, 1x flange,  
1x flexible coupling,  
4x screws to connect on the  
cylinder's side,  
4x screws to connect on the  
motor's side,  
3x seals, 4x seal washers

Ø32-40-50-63

Ø80-100

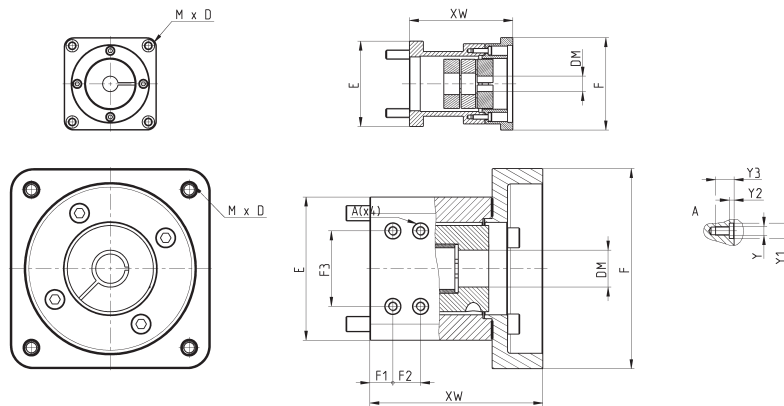

Mod.	Size	Protection class	Motor	$\varnothing_{DM}$	E	F	F1	F2	F3	Y	Y1	Y2	Y3	XW	Weight (g)	$\eta$
AM-6E-32-0100	32	IP40	MTB-010-...	8	46.5	42	-	-	-	-	-	-	-	55	165	0.78
AM-6E-32-0100P	32	IP65	MTB-010-...	8	46.5	42	-	-	-	-	-	-	-	55	165	0.78
AM-6E-32-0023	32	IP40	MTS-23-...	6.35	46.5	56.4	-	-	-	-	-	-	-	53	240	0.78
AM-6E-32-0023P	32	IP65	MTS-23-...	6.35	46.5	56.4	-	-	-	-	-	-	-	53	240	0.78
AM-6E-32-0024P	32	IP65	MTS-24-...	8	46.5	60	-	-	-	-	-	-	-	53.5	240	0.78
AM-6E-40-0400	40	IP40	MTB-040-...	14	55.4	60	-	-	-	-	-	-	-	67	290	0.78
AM-6E-40-0400P	40	IP65	MTB-040-...	14	55.4	60	-	-	-	-	-	-	-	67	290	0.78
AM-6E-40-0023	40	IP40	MTS-23-...	6.35	55.4	56.4	-	-	-	-	-	-	-	56	365	0.78
AM-6E-40-0023P	40	IP65	MTS-23-...	6.35	55.4	56.4	-	-	-	-	-	-	-	56	365	0.78
AM-6E-40-0024P	40	IP65	MTS-24-...	8	55.4	60	-	-	-	-	-	-	-	55	365	0.78
AM-6E-50-0400	50	IP40	MTB-040-...	14	64.9	60	-	-	-	-	-	-	-	73	435	0.78
AM-6E-50-0400P	50	IP65	MTB-040-...	14	64.9	60	-	-	-	-	-	-	-	73	435	0.78
AM-6E-50-0750P	50	IP65	MTB-075-...	19	64.9	80	-	-	-	-	-	-	-	86	746	0.78
AM-6E-50-0024	50	IP40	MTS-24-...	8	64.9	58	-	-	-	-	-	-	-	63	415	0.78
AM-6E-50-0024P	50	IP65	MTS-24-...	8	64.9	58	-	-	-	-	-	-	-	63	415	0.78
AM-6E-50-0034P	50	IP65	MTS-34-...	14	64.9	86	-	-	-	-	-	-	-	83	785	0.78
AM-6E-63-0750	63	IP40	MTB-075-...	19	75	80	-	-	-	-	-	-	-	90	845	0.78
AM-6E-63-0750P	63	IP65	MTB-075-...	19	75	80	-	-	-	-	-	-	-	90	845	0.78
AM-6E-63-0024	63	IP40	MTS-24-...	8	75	60.5	-	-	-	-	-	-	-	71	480	0.78
AM-6E-63-0024P	63	IP65	MTS-24-...	8	75	60.5	-	-	-	-	-	-	-	71	480	0.78
AM-6E-63-0034P	63	IP65	MTS-34-...	14	75	86	-	-	-	-	-	-	-	88	1025	0.78
AM-6E-80-1000P	80	IP65	MTB-100-...	24	93	130	15	18	49	M6	10	3.1	12	112.5	2510	0.78
AM-6E-80-0034P	80	IP65	MTS-34-...	14	93	93	15	18	49	M6	10	3.1	12	94.5	1885	0.78
AM-6E-100-1000P	100	IP65	MTB-100-...	24	115	130	15	18	62	M8	12	3.1	18	115.5	3465	0.78
AM-6E-100-0034P	100	IP65	MTS-34-...	14	115	93	15	18	62	M8	12	3.1	18	97.5	2840	0.78

**Kit for axial connection Mod. AR**

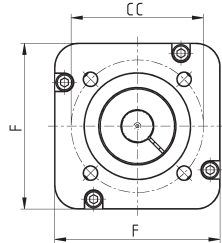
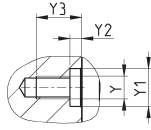
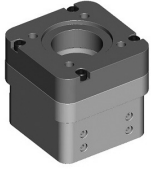

Supplied with:  
2x flanges (1 for size 80)  
8x screws  
1x coupling  
2x seals (1 for size 80)

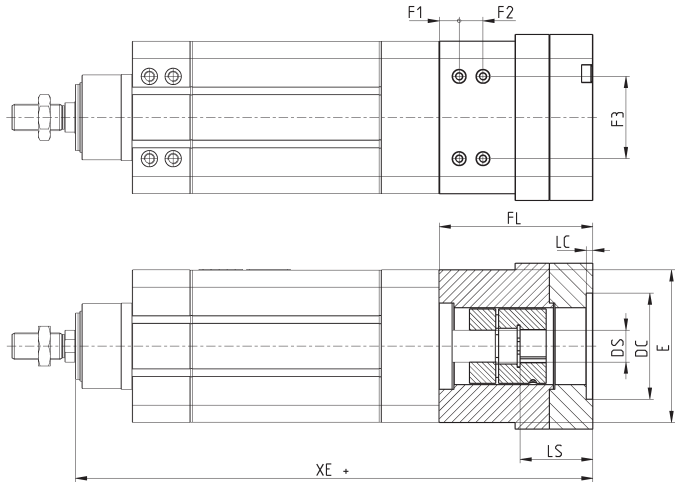

SERIES 6E ELECTROMECHANICAL CYLINDERS

Mod.	Size	Protection class	Gearbox	XE+	FL	F	E	DC	LC	CC	F1	F2	F3	Y	Y1	Y2	Y3	DS	LS	Weight (g)
AR-6E-50-R060P	50	IP65	GB-060	288.2	77.2	-	64.9	40	3	52	-	-	-	-	-	-	-	14	35	630
AR-6E-63-R060P	63	IP65	GB-060	339.3	88.6	-	75	40	4	52	-	-	-	-	-	-	-	14	35	1100
AR-6E-80-R080P	80	IP65	GB-080	358	98	-	93	60	5	70	15	18	49	6	10	3.1	12	20	40	2090
AR-6E-100-R120P	100	IP65	GB-120	399.8	116.8	125	115	80	5	100	15	18	62	8	12	3.1	18	25	55	3800

## Kit for parallel connection Mod. PM



The kit includes:

- 1x front cover
- 1x rear cover
- 2x pulleys
- 2x locking sets
- 1x toothed belt
- 1x belt traction unit
- 4x screws for cylinder's side
- 4x cover rear screws
- + seal washers
- 6x cover fixing screws
- 3x seals
- 1x seal plug
- 4x motor seal washers

Detailed information about the size of interfaceable motors and reducers can be found further on in the dedicated sections.

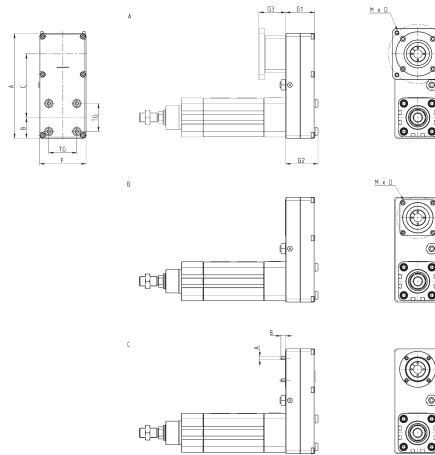

Mod.	Size	Protection class	Gearbox	Motor	G3	A	F	G1	G2	B	C	TG	Weight (g)	$\eta$
PM-6E-32-0100P	32	IP65	-	MTB-010-...	-	122	54	35	39.5	26.5	65	32.5	450	0.62
PM-6E-32-0024P	32	IP65	-	MTS-24-...	30	122	54	35	39.5	26.5	65	32.5	450	0.62
PM-6E-40-0400P	40	IP65	-	MTB-040-...	-	154	67	46	50.5	30	90	38	960	0.62
PM-6E-40-0024P	40	IP65	-	MTS-24-...	-	154	67	46	50.5	30	90	38	960	0.62
PM-6E-50-0400P	50	IP65	-	MTB-040-...	-	174	77	48	53.5	34.5	105.5	46.5	1375	0.62
PM-6E-50-0034P	50	IP65	-	MTS-34-...	44.5	174	77	48	53.5	34.5	105.5	46.5	1375	0.62
PM-6E-50-R060P	50	IP65	GB-060	MTB-040-...	-	174	77	48	53.5	34.5	105.5	46.5	1375	0.62
PM-6E-63-0750P	63	IP65	-	MTB-075-...	-	192	87	50	55.5	41	107	56.5	1675	0.62
PM-6E-63-0034P	63	IP65	-	MTS-34-...	-	192	87	50	55.5	41	107	56.5	1675	0.62
PM-6E-63-R060P	63	IP65	GB-060	MTB-040-...	-	192	87	50	55.5	41	107	56.5	1675	0.62
PM-6E-80-1000P	80	IP65	-	MTB-100-...	-	310	135	70	77	65	180	72	4457	0.62
PM-6E-80-0034P	80	IP65	-	MTS-34-...	-	310	135	70	77	65	180	72	4457	0.62
PM-6E-80-R080P	80	IP65	GB-080	MTB-075-...	-	310	135	70	77	65	180	72	4457	0.62
PM-6E-100-1000P	100	IP65	-	MTB-100-...	-	310	135	70	77	65	180	89	4457	0.62
PM-6E-100-0034P	100	IP65	-	MTS-34-...	-	310	135	70	77	65	180	89	4457	0.62
PM-6E-100-R080P	100	IP65	GB-080	MTB-075-...	-	310	135	70	77	65	180	89	4457	0.62



**Cylinder bracket Mod. BA-6E**

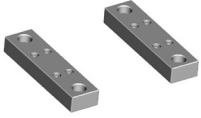

Supplied with:  
2x feet  
8x centering rings  
8x screws

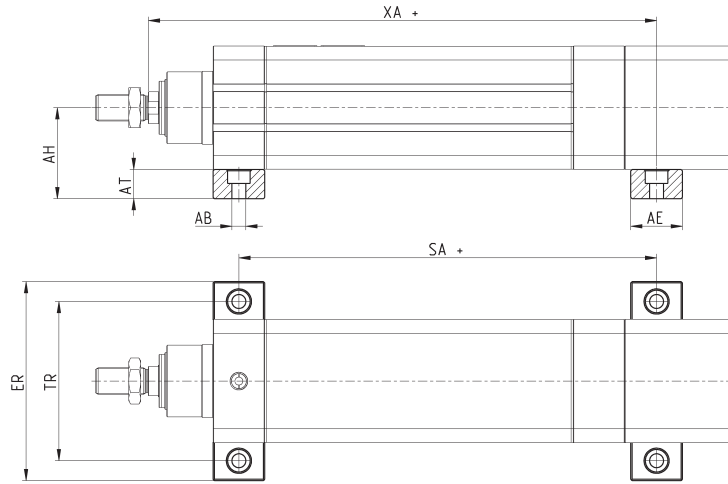

Mod.	Size	XA	AH	AT	AB	SA	ER	TR	AE	Weight (g)
BA-6E-80	80	283.85	68.5	22	10.5	215.5	150	120	39	630
BA-6E-100	100	306.85	79.5	22	10.5	234	170	140	44	800

### Foot bracket Mod. B-6E



Material: zinc-plated steel

Supplied with:  
2x feet  
8x screws

\* Mounting available for sizes 32, 40, 50 and 63 only

+ = add the stroke

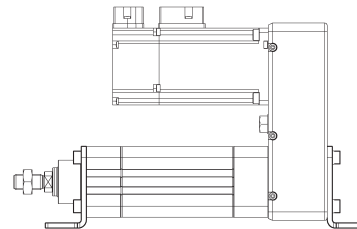
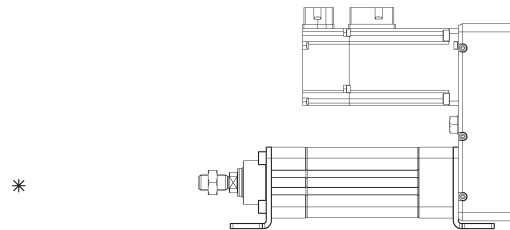
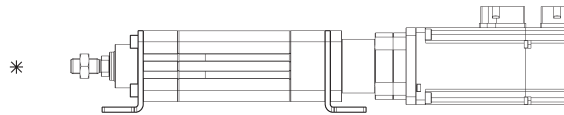
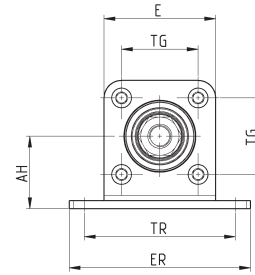
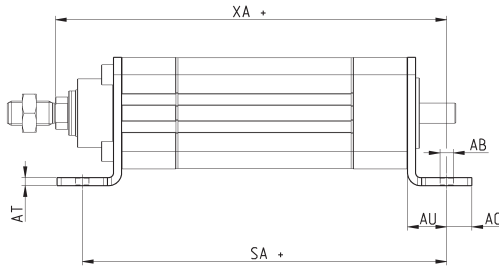

Mod.	Size	SA	XA	AH	TG	TR	AT	AU	AO	AB	ER	E	Weight (g)
B-6E-32	32	164	174.5	32	32.5	65	4	19.5	12.5	6.6	79	46.5	275
B-6E-40	40	181	194.5	36	38	75	4	19.5	12.5	6.6	90	55.4	340
B-6E-50	50	223	236	45	46.5	90	5	25	15	9	110	64.9	635
B-6E-63	63	251	267.5	50	56.5	100	5	25	15	9	120	75	755
B-6E-80	80	278	293.5	68.5	72	120	6	33.5	17.5	10.5	140	93	1300
B-6E-100	100	299	316.5	79.5	89	140	6	33.5	17.5	10.5	170	115	1800

### Front spot faced trunnion Mod. FN

Material: zinc-plated steel



Supplied with:  
1x spot faced trunnion  
4x screws

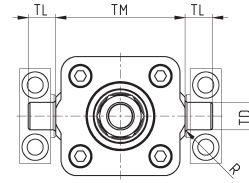
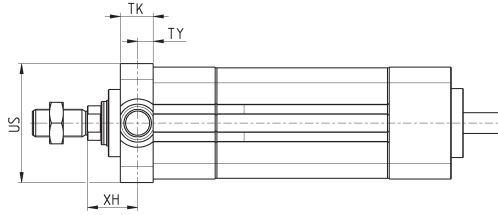

Mod.	∅	TK	TY	XH	US	TL	TM	∅TD	R	torque force
FN-32	32	14	6.5	23.5	46	12	50	12	1	5 Nm
FN-40	40	19	9	24	59	16	63	16	1.5	5 Nm
FN-50	50	19	9	29	69	16	75	16	1.6	10 Nm
FN-63	63	24	11.5	30.5	84	20	90	20	1.6	10 Nm
FN-80	80	24	11.5	34.5	102	20	110	20	1.6	15 Nm
FN-100	100	29	14	37	125	25	132	25	2	15 Nm

### Counter bracket for front trunnion Mod. BF

Material: aluminium

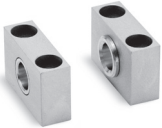

Supplied with:  
2x supports

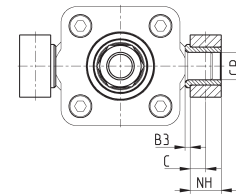
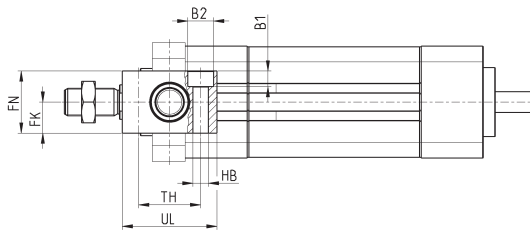

Mod.	∅	∅CR	NH	C	B3	TH	UL	FK	FN	B1	B2	HB
BF-32	32	12	15	7.5	3	32	46	15	30	6.8	11	6.6
BF-40-50	40 - 50	16	18	9	3	36	55	18	36	9	15	9
BF-63-80	63 - 80	20	20	10	3	42	65	20	40	11	18	11
BF-100-125	100 - 125	25	25	12.5	3.5	50	75	25	50	13	20	14

## Front flange Mod. D-E

Material: aluminium

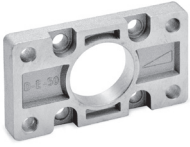

Supplied with:  
1x flange  
4x screws

+ = add the stroke

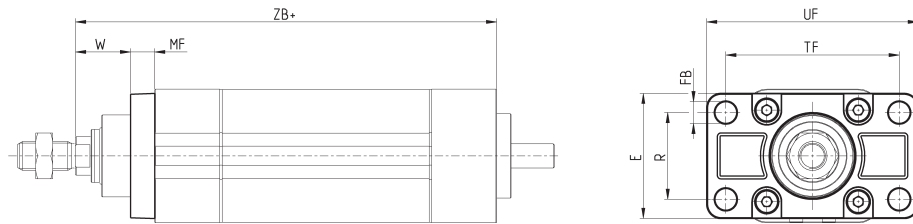

Mod.	Size	W	MF	ZB+	TF	R	UF	E	FB	torque force
D-E-41-32	32	20	10	155	64	32	86	45	7	6 Nm
D-E-41-40	40	23	10	175	72	36	88	52	9	6 Nm
D-E-41-50	50	26.5	12	211	90	43	110	63	9	13 Nm
D-E-41-63	63	30	12	242.5	100	50	116	73	9	13 Nm
D-E-41-80	80	30	16	260	126	63	148	95	12	15 Nm
D-E-41-100	100	35	16	283	150	75	176	115	14	15 Nm

## Side clamping bracket Mod. BG

Material: aluminium



Supplied with:  
2x clamps

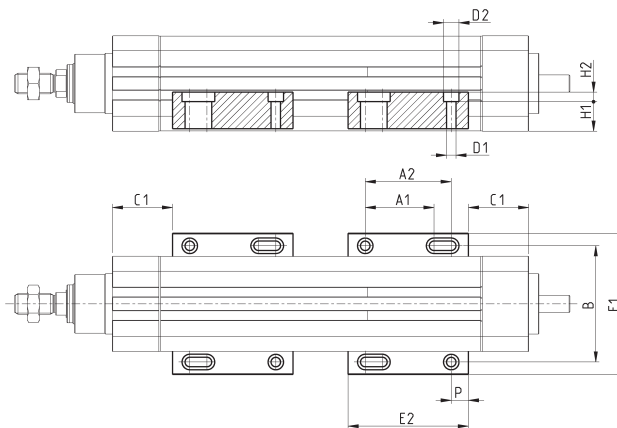

Mod.	Size	C1	E1	E2	P	A1	A2	B	Screw	øD1	øD2	H1	H2	Weight (g)
BG-6E-32	32	35	71	70	10	40	50	58.5	M4	4.5	7.5	13.5	4.5	80
BG-6E-40	40	35	82	70	10	40	50	67.5	M5	5.5	9	16.9	5.5	105
BG-6E-50	50	35	93	70	10	40	50	76.5	M6	6.5	10.5	19.4	6.5	125
BG-6E-63	63	35	103.5	70	10	40	50	87	M6	6.5	10.5	18.9	6.5	125
BG-6E-80	80	45	131	90	17.5	50	60	111.6	M8	8.5	14	22.5	8.5	260
BG-6E-100	100	50	153	90	17.5	50	60	133.6	M8	8.5	14	28	8.5	300

### Rear male trunnion Mod. L

Material: aluminium

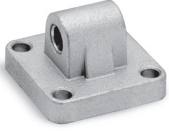

Supplied with:  
1x male trunnion  
4x screws

+ = add the stroke

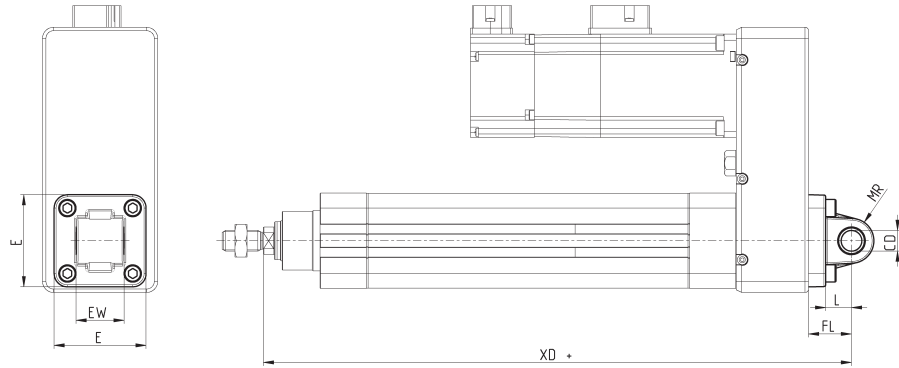

Mod.	Size	$\varnothing$ CD	L	FL	XD+	MR	E	EW	torque force
L-41-32	32	10	12	22	212	10	45	26	6 Nm
L-41-40	40	12	15	25	246	13	53.5	28	6 Nm
L-41-50	50	12	15	27	286	13	62.5	32	13 Nm
L-41-63	63	16	20	32	324.5	17	73	40	13 Nm
L-41-80	80	16	24	36	373	17	92	50	15 Nm
L-41-100	100	20	29	41	401	21	108.5	60	15 Nm

### Rear female trunnion Mod. C and C-H

Material: aluminium

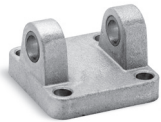

Supplied with:  
1x female trunnion  
4x screws

+ = add the stroke

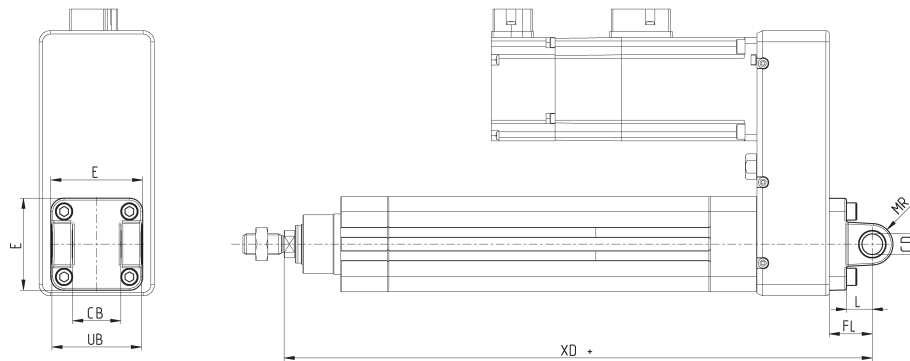

Mod.	Size	$\varnothing$ CD	L	FL	XD+	MR	E	CB	UB	torque force
C-41-32	32	10	12	22	212	10	45	26	45	6 Nm
C-41-40	40	12	15	25	246	12	53.5	28	52	6 Nm
C-41-50	50	12	15	27	286	13	62.5	32	60	13 Nm
C-H-41-63	63	16	20	32	324.5	17	73	40	70	13 Nm
C-H-41-80	80	16	24	36	373	17	92	50	90	15 Nm
C-H-41-100	100	20	29	41	401	21	108.5	60	110	15 Nm

**Accessory combination Mod. C+L+S**

Material: aluminium

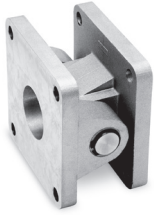

+ = add the stroke

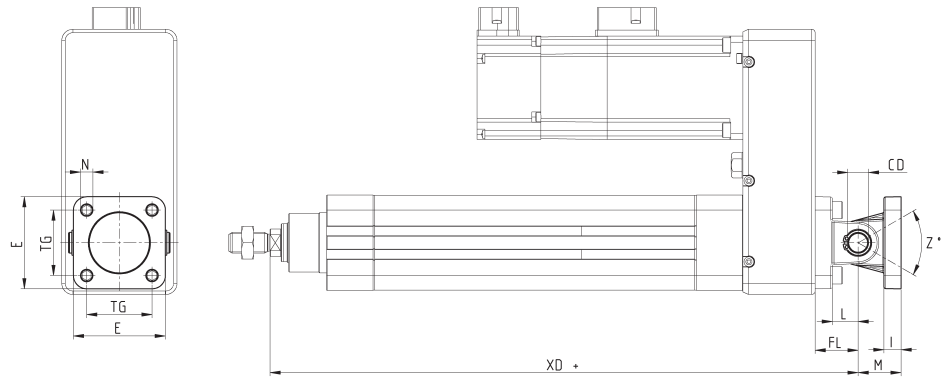

Mod.	Size	E	TG	$\varnothing$ N	XD+	$\varnothing$ CD	L	FL	I	M	Z' (max)	torque force
C+L+S	32	45	32.5	6.5	142	10	12	22	10	22	30	6 Nm
C+L+S	40	53.5	38	6.5	160	12	15	25	10	25	40	6 Nm
C+L+S	50	62.5	46.5	9	170	12	15	27	12	27	25	13 Nm
C+L+S	63	73	56.5	9	190	16	20	32	12	32	36	13 Nm
C+L+S	80	92	72	11	373	16	24	36	12	36	34	15 Nm
C+L+S	100	108.5	89	11	401	20	29	41	12	41	38	15 Nm

**90° male trunnion Mod. ZC**

CETOP RP 107P  
Material: aluminium

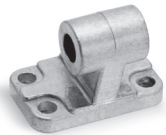

Supplied with:  
1x male support

+ = add the stroke

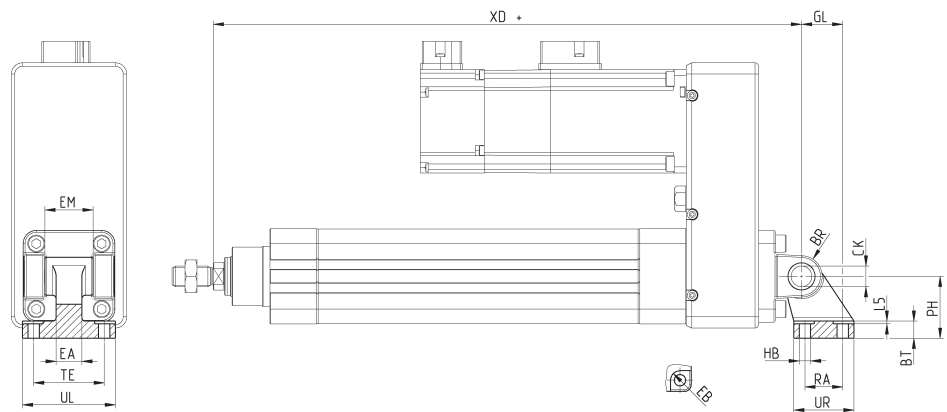

Mod.	Size	$\varnothing$ EB	$\varnothing$ CK	$\varnothing$ HB	XD+	TE	UL	EA	GL	L5	RA	EM	UR	PH	BT	BR
ZC-32	32	11	10	6.6	212	38	51	10	21	1.6	18	26	31	32	8	10
ZC-40	40	11	12	6.6	246	41	54	15	24	1.6	22	28	35	36	10	11
ZC-50	50	15	12	9	286	50	65	16	33	1.6	30	32	45	45	12	13
ZC-63	63	15	16	9	324.5	52	67	16	37	1.6	35	40	50	50	14	15
ZC-80	80	18	16	11	373	66	86	20	47	2.5	40	50	60	63	14	15
ZC-100	100	18	20	11	401	76	96	20	55	2.5	50	60	70	71	17	19

### Trunnion ball-joint Mod. R

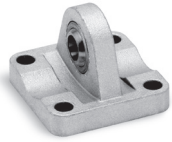

This trunnion doesn't comply with the ISO 15552 standard  
Material: aluminium

Supplied with:  
1x trunnion ball joint  
4x screws

+ = add the stroke

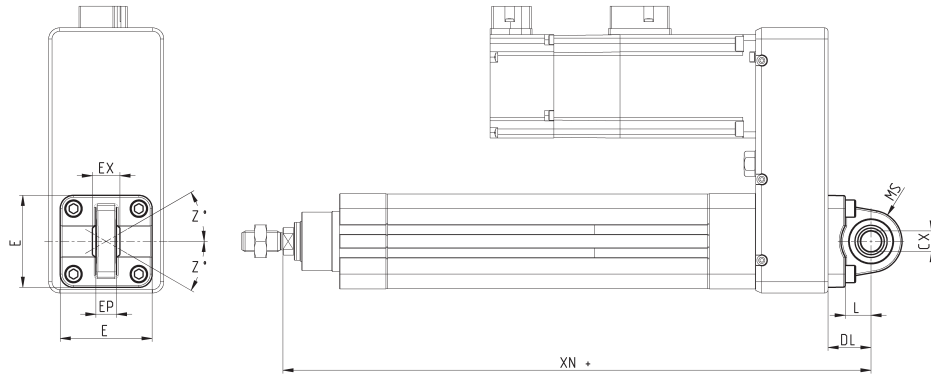

Mod.	Size	$\varnothing$ CX	L	DL	XN+	MS	E	EX	RP	Z	torque force
R-41-32	32	10	12	22	212	18	45	14	10.5	4°	6 Nm
R-41-40	40	12	15	25	246	18	53.5	16	12	4°	6 Nm
R-41-50	50	12	15	27	286	21	62.5	16	12	4°	13 Nm
R-41-63	63	16	20	32	324.5	23	73	21	15	4°	13 Nm
R-41-80	80	16	24	36	373	28	92	21	15	4°	15 Nm
R-41-100	100	20	29	41	401	30	108.5	25	18	4°	15 Nm

### Clevis pin Mod. S



Supplied with:  
1x clevis pin in  
stainless steel 303  
2x Seeger in steel

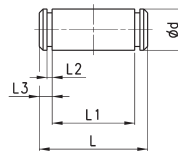

Mod.	Size	$\varnothing$ d	L	L1	L2	L3
S-32	32	10	52	46	1.1	3
S-40	40	12	59	53	1.1	3
S-50	50	12	67	61	1.1	3
S-63	63	16	77	71	1.1	3
S-80	80	16	97	91	1.1	3
S-100	100	20	121	111	1.3	5

## Swivel ball joint Mod. GA



ISO 8139.  
Material: zinc-plated steel

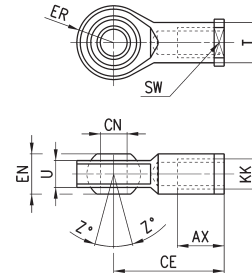

Mod.	$\varnothing$ CN <sup>(H7)</sup>	U	EN	ER	AX	CE	KK	$\varnothing$ T	Z	SW
GA-32	10	10,5	14	14	20	43	M10X1,25	15	6,5	17
GA-40	12	12	16	16	22	50	M12X1,25	17,5	6,5	19
GA-50-63	16	15	21	21	28	64	M16X1,5	22	7,5	22
GA-80-100	20	18	25	25	33	77	M20x1,5	27,5	7	30

## Piston rod socket joint Mod. GY



Material: zama and zinc-plated steel

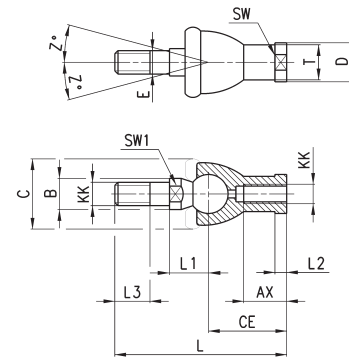

Mod.	Size	KK	AX	CE	E	L	L1	L2	L3	SW	SW1	$\varnothing$ B	$\varnothing$ C	$\varnothing$ D	$\varnothing$ T	Z
GY-32	32	M10X1.25	18	35	10	74	19.5	6.5	15	17	11	14	28	19	15	15
GY-40	40	M12X1.25	20	40	12	84	21	6.5	17	19	17	19	32	22	17.5	15
GY-50-63	50-63	M16X1.5	27	50	16	112	27.5	8	23	22	19	22	40	27	22	11
GY-80-100	80-100	M20x1.5	38	63	20	133	31.5	10	25	30	24	27	45	34	27.5	7.5

## Rod fork end Mod. G

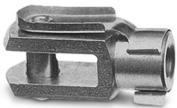

ISO 8140  
Material: zinc-plated steel

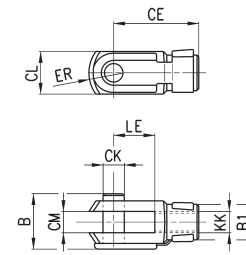

Mod.	$\varnothing$ CK	LE	CM	CL	ER	CE	KK	B	$\varnothing$ B1
G-25-32	10	20	10	20	12	40	M10 X 1.25	26	18
G-40	12	24	12	24	14	48	M12 X 1.25	32	20
G-50-63	16	32	16	32	19	64	M16 X 1.5	40	26
G-80-100	20	40	20	40	25	80	M20 X 1.5	48	34

## Piston rod lock nut Mod. U



ISO 4035  
Material: zinc-plated steel

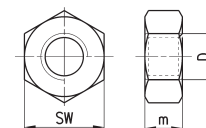

Mod.	D	m	SW
U-25-32	M10X1.25	6	17
U-40	M12X1.25	7	19
U-50-63	M16X1.5	8	24
U-80-100	M20x1.5	9	30



### Self aligning rod Mod. GK

Material: zinc-plated steel

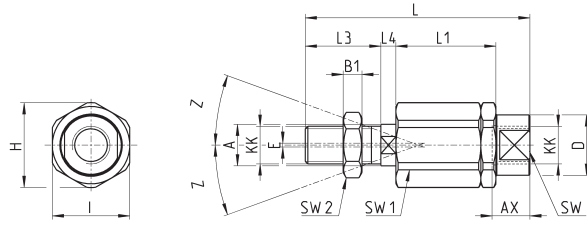

Mod.	Size	KK	L	L1	L3	L4	$\varnothing A$	$\varnothing D$	H	I	SW	SW1	SW2	B1	AX	Z	E
<b>GK-25-32</b>	32	M10x1.25	71.5	35	20	7.5	14	22	32	30	19	12	17	5	22	4	2
<b>GK-40</b>	40	M12x1.25	75.5	35	24	7.5	14	22	32	30	19	12	19	6	22	4	2
<b>GK-50-63</b>	50-63	M16x1.5	104	53	32	10	22	32	45	41	27	20	24	8	30	3	2
<b>GK-80-100</b>	80-100	M20x1.5	119	53	40	10	22	32	45	41	27	20	30	10	37	3	2

### Coupling piece Mod. GKF

Material: zinc-plated steel

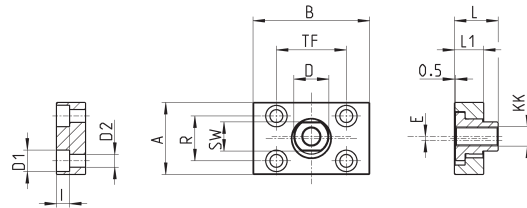
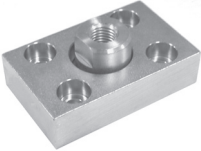

Mod.	Size	KK	A	B	R	TF	L	L1	I	$\varnothing D$	$\varnothing D1$	$\varnothing D2$	SW	E
<b>GKF-25-32</b>	32	M10x1.25	37	60	23	36	22.5	15	6.8	18	11	6.6	15	2
<b>GKF-40</b>	40	M12x1.25	56	60	38	42	22.5	15	9	20	15	9	15	2.5
<b>GKF-50-63</b>	50-63	M16x1.5	80	80	58	58	26.5	15	10.5	25	18	11	22	2.5
<b>GKF-80-100</b>	80-100	M20x1.5	90	90	65	65	32.5	20	13	30.5	20	14	27	2.5

### Slot cover profile Mod. S-CST-500

Supplied with 500 mm tube

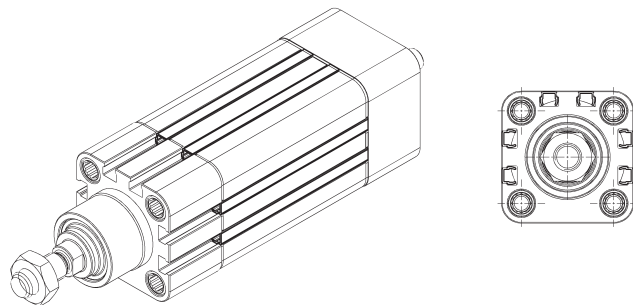

Mod.  
**S-CST-500**