

Series CGA angular grippers

Magnetic

Sizes: Ø 10, 16, 20, 25, 32 mm

SERIES CGA ANGULAR GRIPPERS



- » Compact design
- » Flexible mounting
- » Optional mounting adaptors

For an easier installation the gripper can also be equipped with an optional installation adaptor mod. C-CGP (female) or L-CGP (male).

Series CGA angular grippers are available in 5 different sizes. The gripper opens and closes at angles between -10° and $+30^{\circ}$. The proximity switches can be inserted in the U-shaped grooves on the body. Grippers Series CGA have mounting holes on three sides which provide flexibility in installation.

GENERAL DATA

Model	CGA-10; CGA-16; CGA-20; CGA-25; CGA-32				
Bore sizes	Ø 10; Ø 16; Ø 20; Ø 25; Ø 32				
Type of operation	double-acting				
Operating pressure	1.5 ÷ 7 bar				
Operating temperature	0 ÷ 80°C				
Max. operating frequency	180 cycles/min				
Lubrication	lever section - lubrication required on sliding section				
Grip moment - closed M (Ncm)	1,6xP 8xP 17xP 34xP 61xP		P = operating pressure (bar)		
Grip moment - open M (Ncm)	2,6xP 11xP 23xP 43xP 81xP				
Effective gripping force F (N)	F = M/L x0,85		L = distance of gripping point (cm)		
Length of la. gripping point L (cm)	3,0	4,0	6,0	7,0	8,5
Weight (g)	Ø 10 = 40	Ø 16 = 100	Ø 20 = 200	Ø 25 = 330	Ø 32 = 540
Lever open / closed angles	-10° ÷ $+30^{\circ}$				
Port sizes	M5 (CGA-10 M3)				
Magnet	magnet for proximity sensors in piston				
Fluid	filtered air, without lubrication. If lubricated air is used, it is recommended to use oil ISOVG32. Once applied the lubrication should never be interrupted.				

CODING EXAMPLE

CGA	-	20
------------	---	-----------

CGA	SERIES	PNEUMATIC SYMBOL
20	SIZES: 10 = ø 10 mm 16 = ø 16 mm 20 = ø 20 mm 25 = ø 25 mm 32 = ø 32 mm	PNZ1

SERIES CGA ANGULAR GRIPPERS

PNEUMATIC SYMBOLS

The pneumatic symbols which have been indicated in the CODING EXAMPLE are shown below.

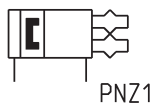

CLOSING GRIPPING FORCE - CHARACTERISTICS

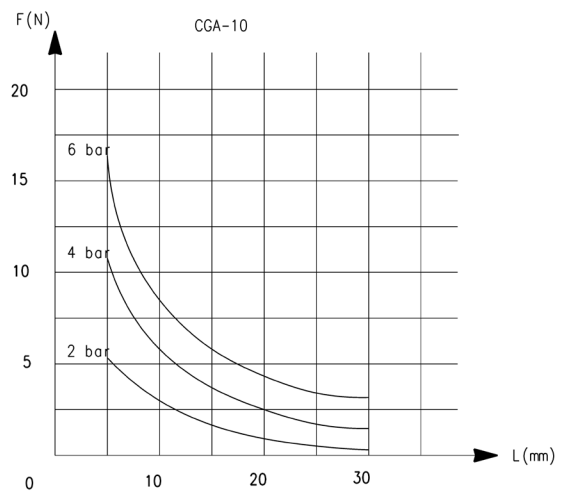
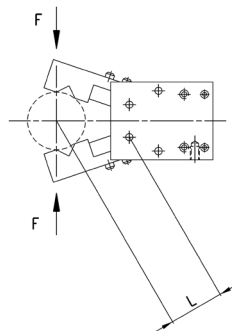

L = Length of gripping point
F = Gripping force

L = Length of gripping point
F = Gripping force

CLOSING GRIPPING FORCE - CHARACTERISTICS

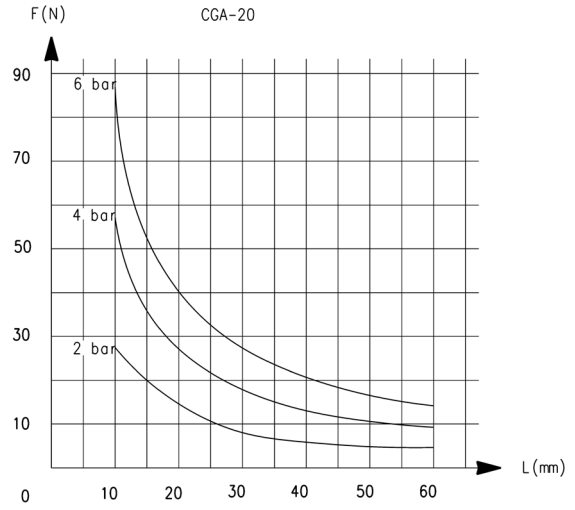
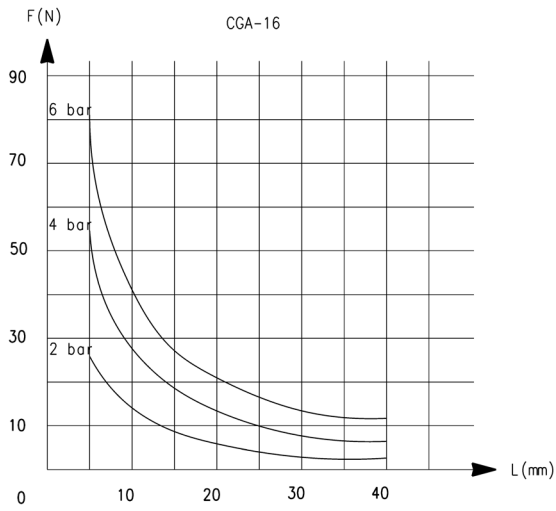

L = Length of gripping point
F = Gripping force

L = Length of gripping point
F = Gripping force

CLOSING GRIPPING FORCE - CHARACTERISTICS

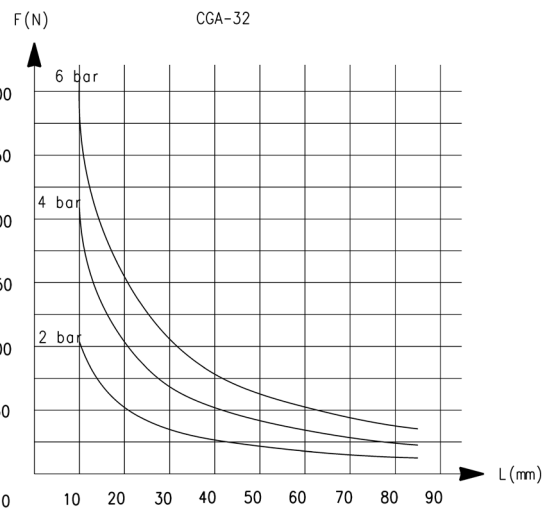
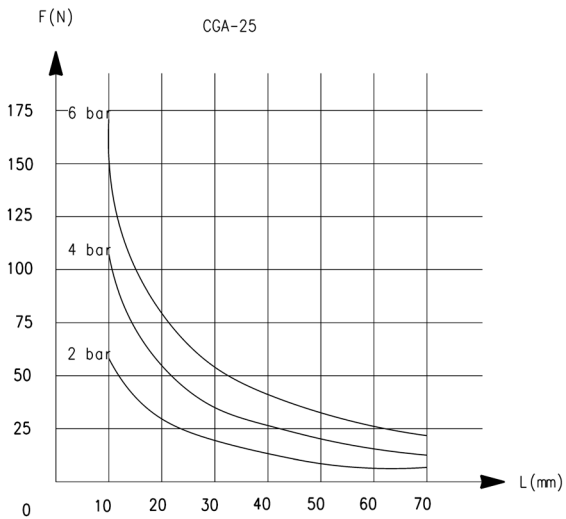

L = Length of gripping point
F = Gripping force

L = Length of gripping point
F = Gripping force

Angular grippers Series CGA

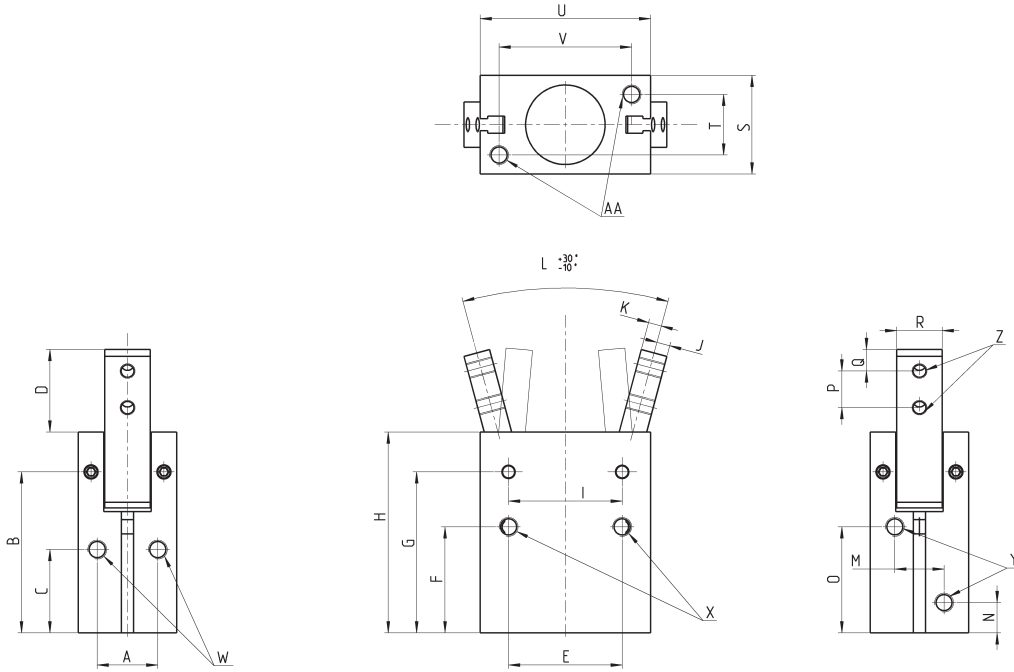

Y = port connection
Z = finger mounting-holes
X.W.AA = mounting holes

DIMENSIONS																						
Mod.	A	B	C	D	E	F	G	H	I	J	K	L	M	N	O	P	Q	R	S	T	U	V
CGA-10	10	30.5	15.5	15.7	18	20	30.5	36.5	14	2.5	1.5	0°	10	7.5	19	6	3	7	16	10	23	17
CGA-16	14	38	21	17.5	24	25.5	38	45.5	24	3	3	0°	12	7.5	25.5	8	3	9	22	14	34	26
CGA-20	16	42,5	22	22	30	28	42.5	53	30	3.5	3.5	0°	13	8	28	10	4	12	26	16	45	35
CGA-25	20	48.5	24.5	26	36	31.5	48.5	61	36	4.5	4.5	0°	18	9	31	12	5	14	32	20	52	40
CGA-32	26	54	30	30	44	37.5	54	68	42	5	5	0°	24	10	33.5	14	6	18	40	26	60	46

DIMENSIONS											
Mod.	X thread	X depth	Y thread	Y depth	W thread	W depth	Z thread	Z depth	AA thread	AA depth	
CGA-10	M3	7	M3	-	M3	-	M3	-	M3	5	
CGA-16	M4	11	M5	-	M4	-	M3	-	M4	7	
CGA-20	M5	13	M5	-	M5	-	M4	-	M5	8	
CGA-25	M6	15	M5	-	M6	-	M5	-	M6	10	
CGA-32	M6	20	M5	-	M6	-	M6	-	M6	10	

Mounting brackets Mod. L-CGP

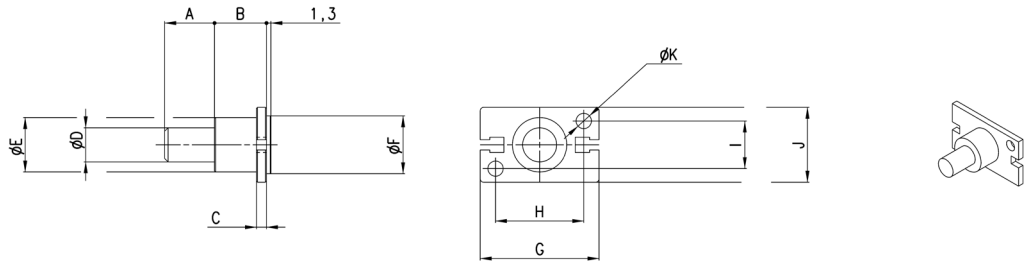

Mod.	A	B	C	D	E	F	G	H	I	J	K
L-CGP-16	15	15	3	10	16	17	35	26	14	22	4,5
L-CGP-20	15	15	3	10	18	21	46	35	16	26	5,5
L-CGP-25	25	17	5	14	26	26	53	40	20	32	6,6
L-CGP-32	25	20	6	16	30	34	61	46	26	40	6,6

Mounting brackets Mod. C-CGP

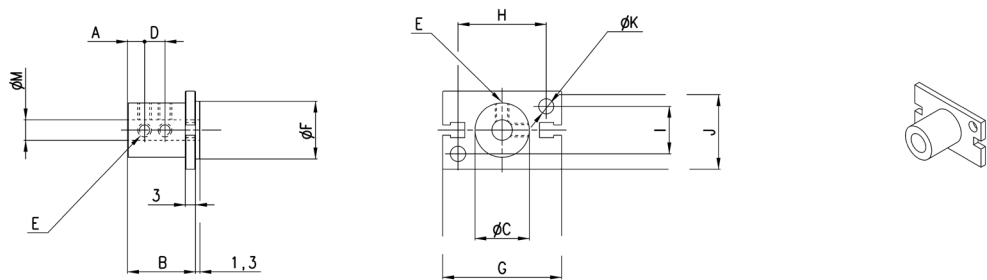

Mod.	A	B	C	D	E	F	G	H	I	J	K	M
C-CGP-16	5	20,5	16	7	M4	17	35	26	14	23	4,5	6
C-CGP-20	7	25,5	20	9	M4	21	46	35	16	27	5,5	8
C-CGP-25	8	30,5	25	10	M4	26	53	40	20	33	6,6	10
C-CGP-32	10	40,5	32	15	M4	34	61	46	26	41	6,6	12