

Series FVT vacuum cup filters

Used as pre-filters and fine filters for air with varying amounts of contamination, for the protection of the vacuum generator. Mounted as protection for the ejector.

SERIES FVT VACUUM CUP FILTERS



- » Wide range of sizes
- » Recycling filter cartridge
- » Replaceable filter element
- » Transparent filter cup to check the filter's conditions

These filters can be mounted directly under the ejectors to protect them in case of dusty environmental conditions. The filter element can be substituted very easily and its conditions can be checked thanks to its transparent wrapping. These filters can be wall-mounted through a proper bracket. Filtering of vacuum and air up to 7 bar.

GENERAL DATA

Description Cup filter

Materials - body in technopolymer
- filter in polyethylene (PE)

CODING EXAMPLE

FVT	-	FF	-	1/4	-	80
------------	----------	-----------	----------	------------	----------	-----------

FVT	SERIES: FVT = cup filter
FF	THREAD SIZE: FF = female-female
1/4	CONNECTIONS: 1/8 = G1/8 1/4 = G1/4 3/8 = G3/8 1/2 = G1/2 3/4 = G3/4
80	FILTER ELEMENT: 80 = 80 µm

TECHNICAL DATA

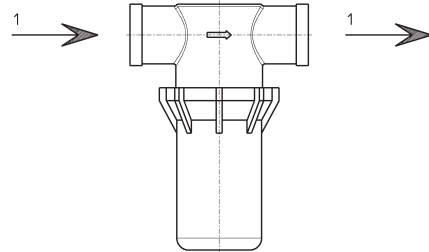

TECHNICAL DATA						
Mod.	Filter element (µm)	Nominal flow (l/min)	Max vacuum (mbar)	Max pressure at 25°C (bar)	Max pressure at 50°C (bar)	Weight (kg)
FVT-FF-1/8-80	80	45	-990	7	5	0,049
FVT-FF-1/4-80	80	110	-990	7	5	0,047
FVT-FF-3/8-80	80	245	-990	7	5	0,079
FVT-FF-1/2-80	80	300	-990	7	5	0,076
FVT-FF-3/4-80	80	600	-990	7	5	0,164

Diagrams FVT

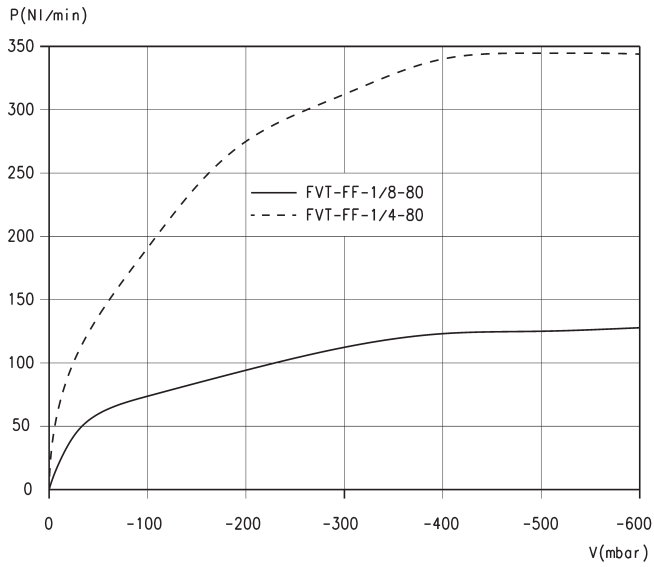

LEGEND:
P = Volumetric flow
V = Vacuum values

Note: Flow rate for different vacuum values

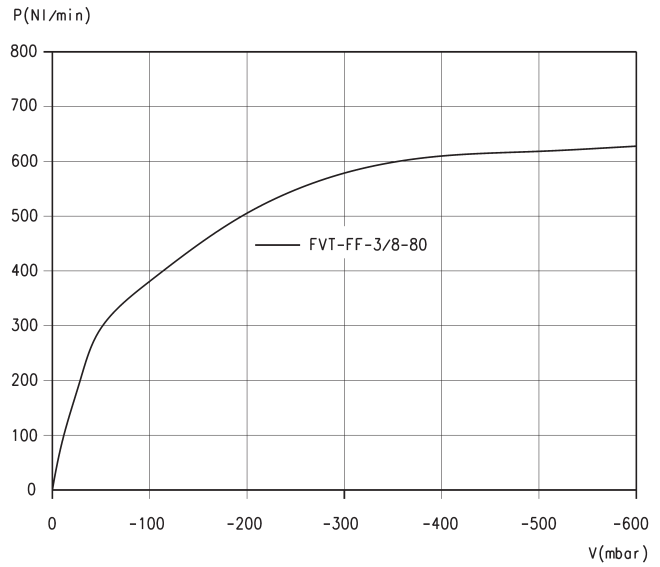

LEGEND:
P = Volumetric flow
V = Vacuum values

Note: Flow rate for different vacuum values

Diagrams FVT

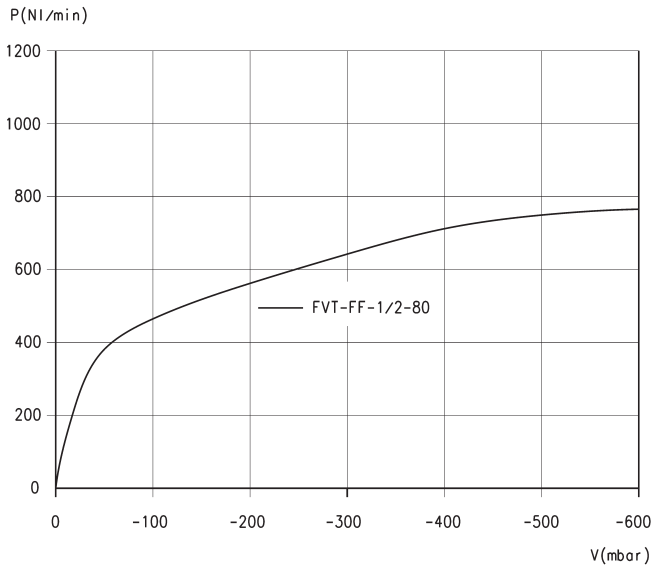

LEGEND:
P = Volumetric flow
V = Vacuum values

Note: Flow rate for different vacuum values

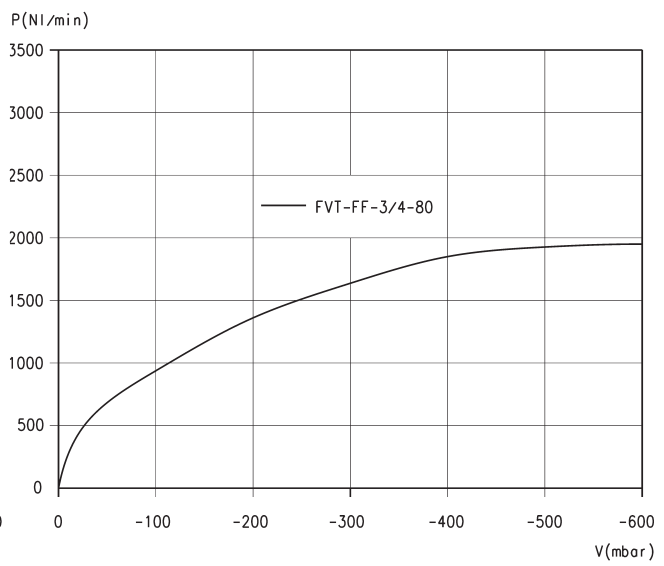

LEGEND:
P = Volumetric flow
V = Vacuum values

Note: Flow rate for different vacuum values

Series FVT cup filter

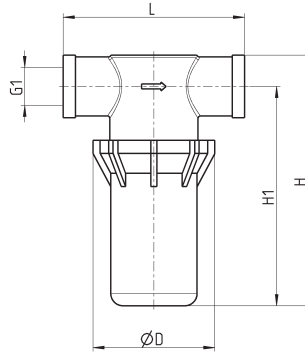

DIMENSIONS					
Mod.	D	G1	H	H1	L
FVT-FF-1/8-80	48	G1/8-F	60	50	58
FVT-FF-1/4-80	48	G1/4-F	60	50	76
FVT-FF-3/8-80	48,5	G3/8-F	97	84	77,2
FVT-FF-1/2-80	48	G1/2-F	101	88	77,2
FVT-FF-3/4-80	75	G3/4-F	137	118	90,5

Mounting foot bracket



The mod. FVT-FF-1/8-80-B is used on cup filters with ports G1/8, G1/4, G3/8 e G1/2.
The mod. FVT-FF-3/4-80-B is used on cup filters with ports G3/4.

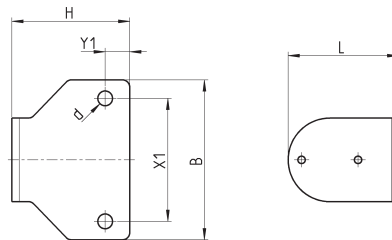

DIMENSIONS						
Mod.	B	d	H	L	X1	Y1
FVT-FF-1/8-80-B	65	6	48	45	50	10
FVT-FF-3/4-80-B	85	6	52	70	70	10