

# Series ER100 digital electro-pneumatic regulators

Port G1/4



- » Compact design
- » Digital display
- » Analog and digital input
- » Programmable
- » Zero/span adjustment function
- » Error display function, pressure display
- » Preset memory function 8-set points (3 bits).

**GENERAL DATA ER104-5xxx**

Model	ER104-5 0/1/2 X Analog type	ER104-5 P X Parallel type
Fluid	filtered compressed air, unlubricated, according to ISO 8573-1 class 3.4.3, inert gas	filtered compressed air, unlubricated, according to ISO 8573-1 class 3.4.3, inert gas
Max. working pressure	7 bar	7 bar
Min. working pressure	Control pressure + max. control pressure x 0,2	Control pressure + max. control pressure x 0,2
Pressure control range	0,3 ÷ 5 bar	0,3 ÷ 5 bar
Class protection	IP40	IP40
Power supply voltage	24 VDC +/- 10% (stabilized power supply with a ripple rate of 1% or less)	24 VDC +/- 10% (stabilized power supply with a ripple rate of 1% or less)
Consumption current	0.15 A (or less rush current 0.6 A or less when power is turned on)	0.15 A (or less rush current 0.6 A or less when power is turned on)
Input signal (Input impedance)	0 ÷ 10 V DC (6,7 kΩ) 0 ÷ 5 V DC (10 kΩ) 4 ÷ 20 mA DC ( 250 Ω)	10 bit
Preset input	8 points	N/A
Output signal Note 1	Analog output 1-5 VDC (load to be connected impedance 500 kW or more) Switch output NPN or PNP, open collector output, 30 V or less, 50 mA or less, voltage drop 2.4 or less, compatible for use with PLC or Relay	Analog output 1-5 VDC (load to be connected impedance 500 kW or more) Switch output NPN or PNP, open collector output, 30 V or less, 50 mA or less, voltage drop 2.4 or less, compatible for use with PLC or Relay
Error Output signal	NPN or PNP open collector output, 30 V or less, 50 mA or less, voltage drop 2,4 V or less, compatible for use with PLC or Relay	NPN or PNP open collector output, 30 V or less, 50 mA or less, voltage drop 2,4 V or less, compatible for use with PLC or Relay
Direct memory setting	0,05 ÷ 5 bar minimum input width 0,01 bar	0,05 ÷ 5 bar minimum input width 0,01 bar
Hysteresis Note 2	0.5% F.S. or less	0.5% F.S. or less
Linearity Note 2	±0.3% F.S. or less	±0.3% F.S. or less
Resolution Note 2	0.2% F.S. or less	0.2% F.S. or less
Repeatability Note 2	0.3% F.S. or less	0.3% F.S. or less
Temperature characteristics: Zero point fluctuation	0.15% F.S./°C or less	0.15% F.S./°C or less
Temperature characteristics: Span point fluctuation	0.07% F.S./°C or less	0.07% F.S./°C or less
Max. flow rate (ANR ) Note 3	400 l/min (see diagram)	400 l/min (see diagram)
Step response time No load Note 4	0.2 sec. or less	0.2 sec. or less
Step response time 1000 cm <sup>3</sup> load Note 4	0.8 sec. or less	0.8 sec. or less
Mechanical vibration proof	98 m/s <sup>2</sup> or less	98 m/s <sup>2</sup> or less
Ambient temperature	5°C ÷ 50 °C	5°C ÷ 50 °C
Fluid temperature	5°C ÷ 50 °C	5°C ÷ 50 °C
Connection port size	G1/4	G1/4
Mounting direction	Free	Free
Weight	250g	250g
Note 1:	Select either analog or switch output.	
Note 2:	This characteristic is guaranteed within a regulation range between 10 and 90% of the full scale, with a power voltage of 24V±10%, a supply pressure of 1 bar higher compared with the set pressure (ex. regulation of 3 bar, supply pressure of 3+1 = 4 bar) and a volume connected to the outlet without any loss. In applications with great air consumption, such as the blowing, the indicated tolerance may change.	
Note 3:	The above apply when working pressure and control pressure are maximum	
Note 4:	The above apply when working pressure is maximum and the step is as follows: 50% F.S. -> 100%F.S. 50% F.S. -> 60% F.S. 50% F.S. -> 40% F.S.	

**GENERAL DATA ER104-9xxx**

	ER104-9 0/1/2 X Analog type	ER104-9P X Parallel type
<b>Model</b>	ER104-9 0/1/2 X Analog type	ER104-9P X Parallel type
<b>Fluid</b>	Filtered air according to ISO 132	Filtered air according to ISO 132
<b>Max. working pressure</b>	10 bar	10 bar
<b>Min. working pressure</b>	Control pressure + Max. control pressure + 1 bar	Control pressure + Max. control pressure + 1 bar
<b>Pressure control range</b>	0,5 ÷ 9 bar	0,5 ÷ 9 bar
<b>Class protection</b>	IP40	IP40
<b>Power supply voltage</b>	DC24V ± 10% (stabilized power supply with a ripple rate of 1% or less)	DC24V ± 10% (stabilized power supply with a ripple rate of 1% or less)
<b>Consumption current</b>	0.15 A or less rush current 0.6 A or less when power is turned on	0.15 A or less rush current 0.6 A or less when power is turned on
<b>Input signal (Input impedance)</b>	0 a 10 VDC (6.7kΩ) 0 a 5 VDC (10kΩ) 4 a 20 mADC (250 Ω)	10 bit
<b>Preset input</b>	8 points	N/A
<b>Output signal Note 1</b>	Analog output 1-5 VDC (load to be connected impedance 500 KW or more ) Switch output NPN or PNP, open collector output, 30 V or less, 50 mA or less voltage drop 2.4.V or less, compatible for usage in PLC and Relay.	Analog output 1-5 VDC (load to be connected impedance 500 KW or more ) Switch output NPN or PNP, open collector output, 30 V or less, 50 mA or less, voltage drop 2.4.V or less, compatible for usage in PLC and Relay.
<b>Error output signal</b>	NPN or PNP, open collector output, 30 V or less, 50 mA or less, voltage drop 2.4 or less, compatible for usage in PLC and Relay	NPN or PNP, open collector output, 30 V or less, 50 mA or less, voltage drop 2.4 or less, compatible for usage in PLC and Relay
<b>Direct memory setting</b>	0,05 ÷ 9 bar minimum input width 0,01 bar setting resolution 0,02 bar	0,05 ÷ 9 bar minimum input width 0,01 bar setting resolution 0,02 bar
<b>Hysteresis Note 2</b>	0.5% F.S. or less	0.5% F.S. or less
<b>Linearity Note 2</b>	±0.3% F.S. or less	±0.3% F.S. or less
<b>Resolution Note 2</b>	0.2% F.S. or less	0.2% F.S. or less
<b>Repeatability Note 2</b>	0.3% F.S. or less	0.3% F.S. or less
<b>Temperature characteristics: Zero point fluctuation</b>	0.15% F.S./°C or less	0.15% F.S./°C or less
<b>Temperature characteristics: Span point fluctuation</b>	0.07% F.S./°C or less	0.07% F.S./°C or less
<b>Max. flow rate Note 3</b>	400 l/min (see diagram)	400 l/min (see diagram)
<b>Step response time No load Note 4</b>	0.82 sec. or less	0.2 sec. or less
<b>Step response time 1000 cm<sup>3</sup> load Note 4</b>	0.8 sec. or less	0.8 sec. or less
<b>Mechanical vibration proof</b>	98 m/s <sup>2</sup> or less	98 m/s <sup>2</sup> or less
<b>Ambient temperature</b>	5°C + 50 °C	5°C + 50 °C
<b>Fluid temperature</b>	5°C + 50 °C	5°C + 50 °C
<b>Connecting port size</b>	G1/4	G1/4
<b>Mounting direction</b>	Free	Free
<b>Weight</b>	250g	250g
<b>Note 1</b>	Select either analog or switch output.	
<b>Note 2</b>	This characteristic is guaranteed within a regulation range between 10 and 90% of the full scale, with a power voltage of 24V±10%, a supply pressure of 1 bar higher compared with the set pressure (ex. regulation of 3 bar, supply pressure of 3+1 = 4 bar) and a volume connected to the outlet without any loss. In applications with great air consumption, such as the blowing, the indicated tolerance may change.	
<b>Note 3</b>	The above apply when working pressure and control pressure are maximum.	
<b>Note 4</b>	The above apply when working pressure and control pressure is maximum and the step is as follows: 50% F.S. -> 100%F.S. 50% F.S. -> 60% F.S. 50% F.S. -> 40% F.S.	

**STANDARD CODES**

Models				
ER104-50AP	ER104-52AP	ER104-5PSP	ER104-90SP	ER104-92SP
ER104-50SP	ER104-52SP	ER 104-90AP	ER104-92AP	ER104-9PSP

**CODING EXAMPLE**

<b>ER</b>	<b>1</b>	<b>04</b>	<b>-</b>	<b>5</b>	<b>0</b>	<b>AN</b>
-----------	----------	-----------	----------	----------	----------	-----------

<b>ER</b>	SERIES
<b>1</b>	SIZE: 1 = size 1
<b>04</b>	PORT: 04 = G1/4
<b>5</b>	WORKING PRESSURE: 5 = 0 ÷ 5 bar 9 = 0.5 ÷ 9 bar
<b>0</b>	INPUT: 0 = 0 - 10 V DC 1 = 0 - 5 V DC 2 = 4 - 20 mA P = Parallel 10 bit
<b>AN</b>	OUTPUT: AN = 1 - 5 V analog, error (NPN) AP = 1 - 5 V analog, error (PNP) SN = switch (NPN), error (NPN) SP = switch (PNP), error (PNP)

DIAGRAMS

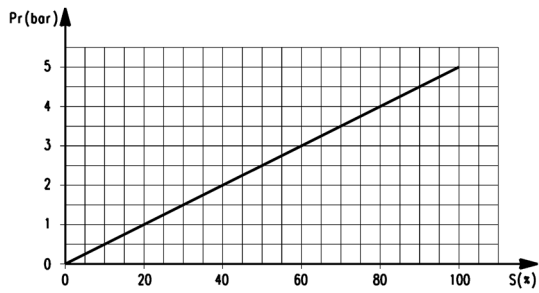

ER104-5xxx  
Input/Output characteristics

Pr = outlet pressure (bar)  
S = input signal (%)

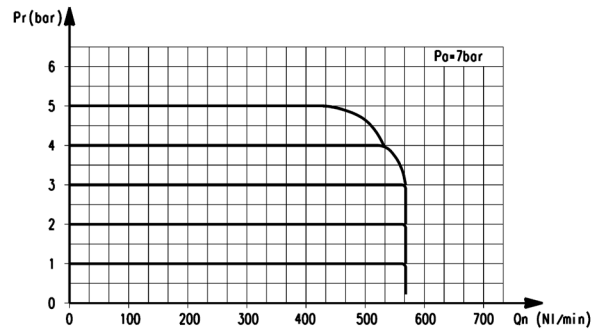

ER104-5xxx  
Flow characteristics

Pr = outlet pressure (bar)  
Qn = flow (l/min)  
Pa = operating pressure (bar)

DIAGRAMS

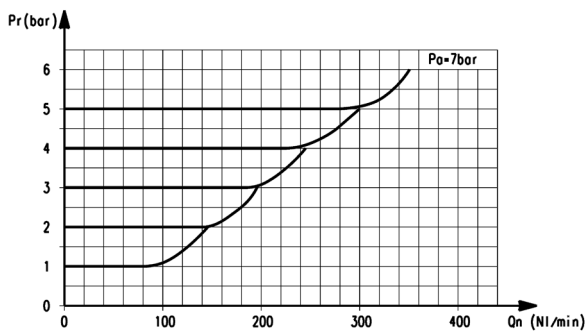

ER104-5xxx  
Exhaust characteristics

Pr = outlet pressure (bar)  
Qn = flow (l/min)  
Pa = operating pressure (bar)

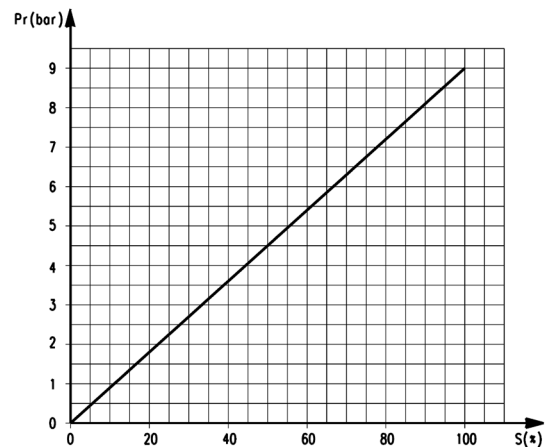

ER104-9xxx  
Input/Output characteristics

Pr = outlet pressure (bar)  
S = input signal (%)

**DIAGRAMS**

SERIES ER100 DIGITAL ELECTRO-PNEUMATIC REGULATORS



ER104-9xxx  
Flow characteristics

Pr = outlet pressure (bar)  
Qn = flow (l/min)  
Pa = operating pressure (bar)

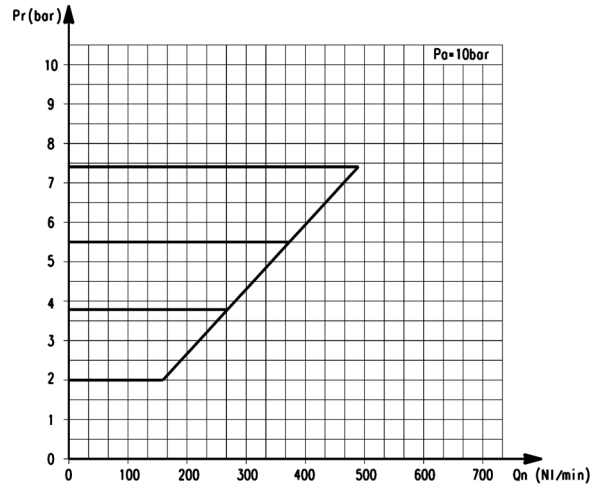

ER104-9xxx  
Exhaust characteristics

Pr = outlet pressure (bar)  
Qn = flow (l/min)  
Pa = operating pressure (bar)

**Proportional regulator Series ER100**

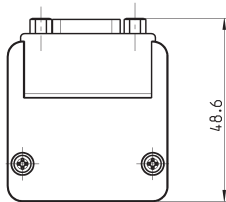
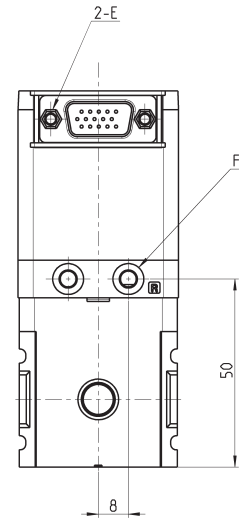
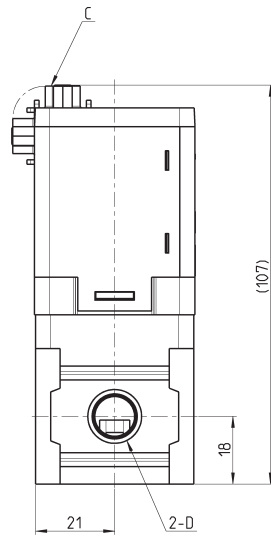
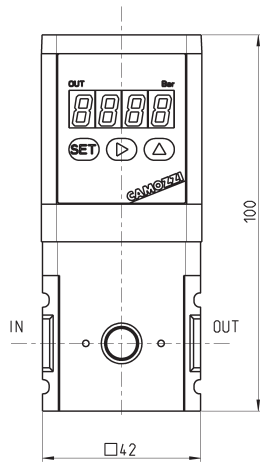
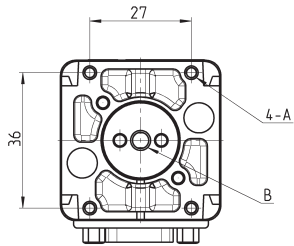
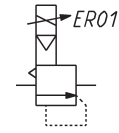

DIMENSIONS						
Mod.	A	B	C	D	E	F
ER104	M3 depth 6	Ø5.3 EXH port	D sub-connector 15 pins/plugs	G1/4	4-40 UNC	Ø4.2 Port R (pilot air exhaust port)

**Bracket ER1-B1**

Floor installation type

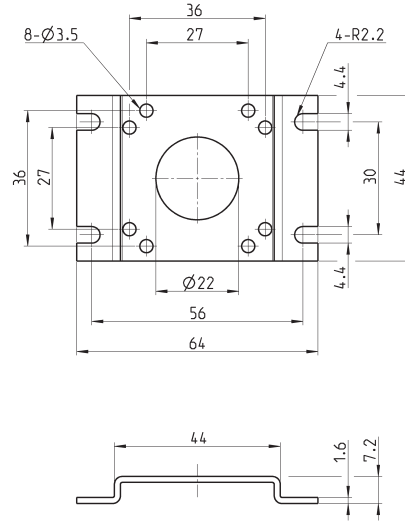

**DIMENSIONS**

Mod.
<b>ER1-B1</b>

**Bracket ER1-B2**

Wall installation type

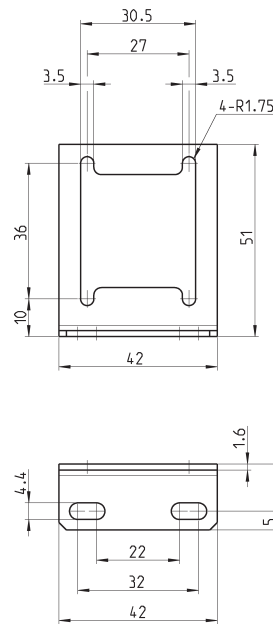

**DIMENSIONS**

Mod.
<b>ER1-B2</b>



### Cable and connector for regulator with analog Input



To check the correspondence between pin and cables' colour, please refer to the instruction sheet included in the packaging or to the user manual.

- 1 = shield wire\*
- 2 = 9-AWG26

\* Connect the shield wire to the power's minus (0 V) side.

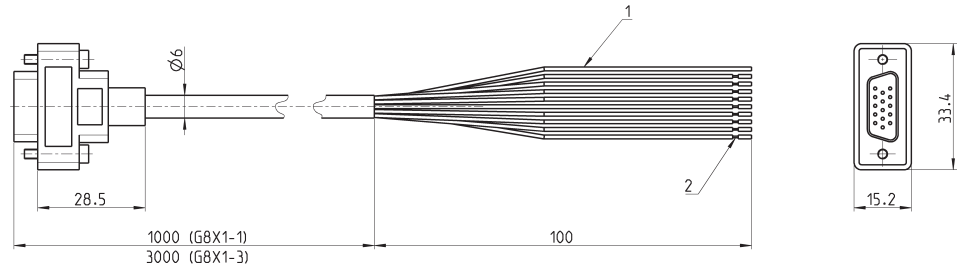

Mod.
G8X1-1
G8X1-3

### Cable and connector for regulator with parallel Input



To check the correspondence between pin and cables' colour, please refer to the instruction sheet included in the packaging or to the user manual.

- 1 = shield wire\*
- 2 = 9-AWG26

\* Connect the shield wire to the power's minus (0 V) side.

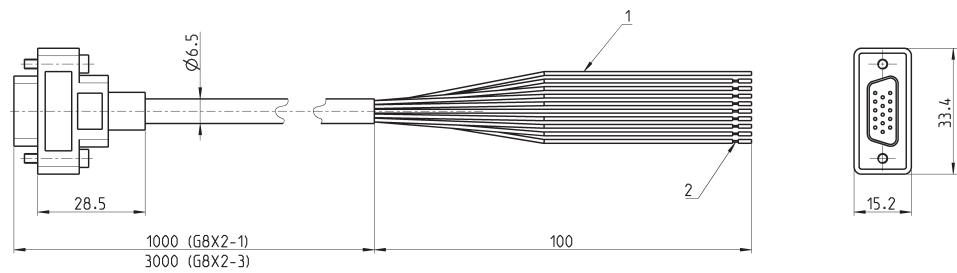

Mod.
G8X2-1
G8X2-3