

New

# Racores super rápidos GRIPfit Serie 7000 - Bebidas y filtración de agua

Diámetros exteriores del tubo: 4, 6, 8 mm  
Roscas: ISO-228 BSPP (G1/8, G1/4, G3/8).



- » Materiales de origen biológico (compuestos)
- » Latón bajo en plomo (CW510L)
- » Conexión y desconexión fáciles

La Serie 7000 bebidas y filtración de agua es una nueva gama de racores super rápidos fabricados en tecnopolímero reforzado de origen biológico y latón con bajo contenido en plomo. Gracias a los materiales y a la nueva tecnología de conexión, estos racores son ideales para sistemas de dispensación de bebidas y filtración de agua.

\*Consulte aquí los modelos con certificación NSF: <https://www.nsf.org/certified-products-systems>

\*\* NSF169 y NSF61 disponibles actualmente para racores rectos de latón. Pronto disponible para toda la gama



## INFORMACIÓN GENERAL

Diámetros	Ø 4 mm - Ø 6 mm - Ø 8 mm
Presión de trabajo máx.	-20° / +40° 16 bar - 16 bar - 16 bar +40° / +70° 16 bar - 14 bar - 12 bar +70° / +100° 16 bar - 12 bar - 10 bar
Presión de trabajo mín.	-0,9 bar
Temperatura	-20 ÷ +100 (ver las características de los tubos usados)
Roscas	GAS cilíndrica ISO-228 BSPP
Tubo de conexión	Poliuretano (PU), Polietileno (PE), Poliamida (PA), Fluoropolímero (PTFE), Poliéster (HY3L), tubo metálico rígido con extremo metálico ranurado liso
Fluidos	Agua potable y de red, bebidas y gas (para otros fluidos consulte a nuestros técnicos)
Materiales	(A) Cuerpo =tecnopolímero (PA11), Latón de bajo plomo (CW510L) (B) Boquilla = tecnopolímero (PA66) (C) Anillo de sujeción = acero inoxidable (AISI 301) (D) Juntas = EPDM (E) Rosca = latón de bajo plomo (CW510L)

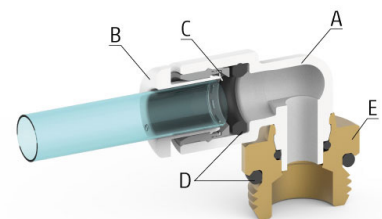

## Racores Mod. B6512



Conector recto macho  
Latón de bajo plomo (CW510L)  
Rosca BSPP ISO-228



NSF169



NSF61

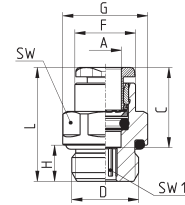

Mod.	A	D	C	F	G	H	L	SW	SW1	Peso (g)
B6512 4-1/8	4	G1/8	14,6	8,8	13,5	6	20	12	2,5	8
B6512 4-1/4	4	G1/4	14,6	8,8	16,4	7	21,5	15	2,5	12
B6512 6-1/8	6	G1/8	15,5	11,7	13,5	6	21	12	4	8
B6512 6-1/4	6	G1/4	15,5	11,7	16,4	7	22	15	4	11
B6512 8-1/8	8	G1/8	17,3	13,7	15,2	6	26	14	5	12
B6512 8-1/4	8	G1/4	17,3	13,7	16,4	7	24,5	15	6	14
B6512 8-3/8	8	G3/8	17,3	13,7	20,5	7	24	19	7	24

## Racores Mod. B6812



Adaptador recto macho  
Latón de bajo plomo (CW510L)  
Rosca BSPP ISO-228



NSF169



NSF61

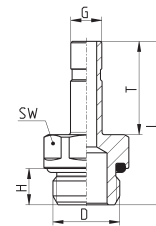

Mod.	D	G	H	L	T	SW	Peso (g)
B6812 4-1/8	G1/8	4	6	29	16,5	12	9
B6812 4-1/4	G1/4	4	7	30	16,5	15	14
B6812 6-1/8	G1/8	6	6	30,5	18	12	10
B6812 6-1/4	G1/4	6	7	31,5	18	15	14,5
B6812 8-1/8	G1/8	8	6	33	20,5	12	12
B6812 8-1/4	G1/4	8	7	34	20,5	15	16,5
B6812 8-3/8	G3/8	8	7	36	20,5	19	26

**Racores Mod. B7522**

Codo giratorio macho  
Rosca BSPP ISO-228

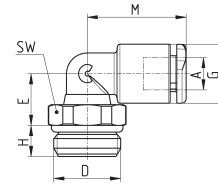

Mod.	A	D	E	G	H	M	SW	Peso (g)
B7522 4-1/8	4	G1/8	9	9,2	5	17	12	7
B7522 4-1/4	4	G1/4	9	9,2	6	17	14	10
B7522 6-1/8	6	G1/8	10	11,4	5	19	12	8
B7522 6-1/4	6	G1/4	10	11,4	6	19	14	11
B7522 8-1/8	8	G1/8	13,5	13,7	5	21,5	12	11
B7522 8-1/4	8	G1/4	12	13,7	6	21,5	14	14
B7522 8-3/8	8	G3/8	12	13,7	7	21,5	19	19

**Racores Mod. B7800**

Unión reductora recta

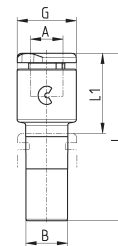

Mod.	A	B	G	L	L1	Peso (g)
B7800 4-6	4	6	9,3	29,5	14	2
B7800 4-8	4	8	9,3	30,5	14	3
B7800 6-8	6	8	11,4	32,5	15,5	4

## Racores Mod. B7555

Codo unión

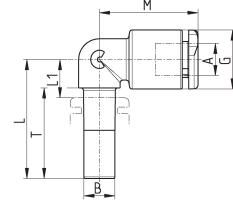

Mod.	A	B	G	L	L1	M	T	Peso (g)
<b>B7555 4-4</b>	4	4	9,2	21	7	17	16,5	2
<b>B7555 6-6</b>	6	6	11,4	23	8	19	17,5	4
<b>B7555 8-8</b>	8	8	13,7	25	9	21,5	18,5	5

## Racores Mod. B7580

Unión recta

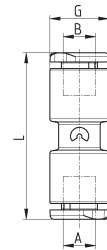

Mod.	A	B	G	L	Peso (g)
<b>B7580 4</b>	4	4	9,2	29,2	4
<b>B7580 6</b>	6	6	11,4	32	6
<b>B7580 8</b>	8	8	13,7	35,4	8

**Racores Mod. B7550**

Codo unión

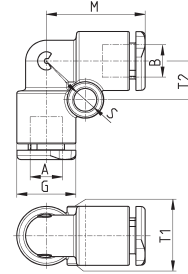

Mod.	A	B	G	M	S	T1	T2	Peso (g)
<b>B7550 4</b>	4	4	9,2	17	4	9,2	6,5	4
<b>B7550 6</b>	6	6	11,4	19	4	11,4	7,5	6
<b>B7550 8</b>	8	8	13,7	21,5	4	13,7	8,5	9

**Racores Mod. B7540**

T unión

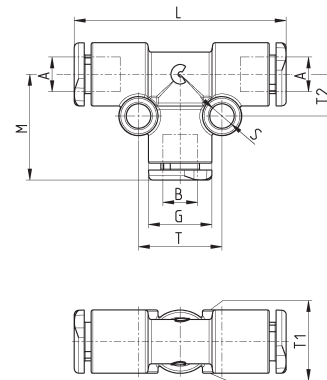

Mod.	A	B	G	L	M	S	T	T1	T2	Peso (g)
<b>B7540 4</b>	4	4	9,2	34	17	4	12	9,2	6,5	6
<b>B7540 6</b>	6	6	11,4	38	19	4	15	11,4	7,5	9
<b>B7540 8</b>	8	8	13,7	43	21,5	4	17	13,7	8,5	14

## Racores Mod. B7560

Y unión

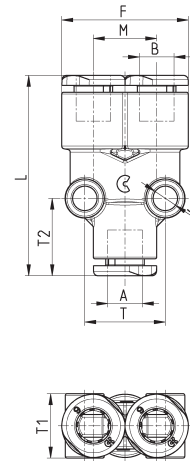

Mod.	A	B	F	L	M	S	T	T1	T2	Peso (g)
<b>B7560 4</b>	4	4	18,2	33,2	9	4	10,8	9,5	13	6
<b>B7560 6</b>	6	6	23	36	11,4	4	14,5	11,5	14	9
<b>B7560 8</b>	8	8	27,2	41,5	13,5	4	17	14	15	15

## Accesorio Mod. B6900

Tapón macho de plástico

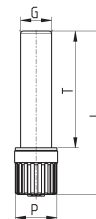

Mod.	G	L	P	T	Peso (g)
<b>B6900 4</b>	4	29	8	20	1
<b>B6900 6</b>	6	31,5	8	22,5	1
<b>B6900 8</b>	8	34,5	12	24,5	2

**Ranura para tubo metálico realizada con la ranuradora Camozzi 8TRT (o mecanizado)**

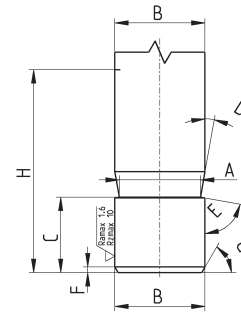

A	B	C	D	E	F	G	H
3,4	4	5,3	10°	80°	0,5	30°	16,5
5,2	6	6,25	10°	80°	0,5	30°	18
7,2	8	6,4	10°	80°	0,5	30°	20

**Ranura para tubo metálico realizada por mecanizado**

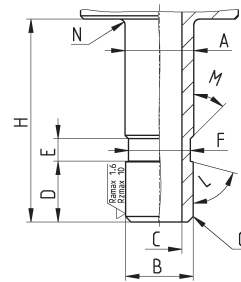

A	B	C	D	E	F	G	H	L	M	N
4,1	4	2	5,3	2	3,5	0,5x45°	16,5	75°	45°	0,5
6,1	6	4	5,4	2	5,5	0,5x45°	18	75°	45°	0,5
8,1	8	6	6	2	7,5	0,5x45°	20,5	75°	45°	0,5

**Herramienta de ranurado para tubos metálicos**

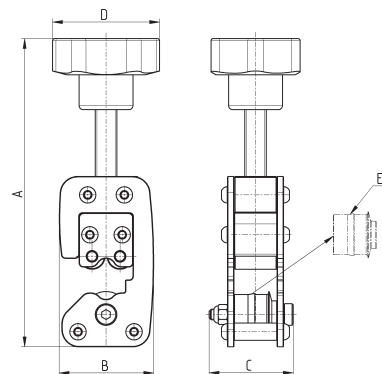

Mod.	Tubo Ø	A (max)	B	C	D	Peso (g)	E (rueda de repuesto)
8TRT 4	4	138	43.5	39	50	450	RTRT 4
8TRT 6	6	140	43.5	39	50	450	RTRT 6
8TRT 8	8	142	43.5	39	50	450	RTRT 8