

Rundzylinder - Serie 27

Produktcode: 27M2A20A0015

Datenblatt Erstellungsdatum: 20.05.26 17:15

Überprüfen Sie das aktualisierte Dokument  [klicken](#)



TECHNISCHE DATEN

Serie	27
Diameter (mm)	20
Version	M = Zylinderkopf hinten mit Schwenkgelenk
Funktion	2 = doppelwirkend
Werkstoff	A = Edelstahl gerollt
Bauart	A = Standard
Hub (mm)	15
Dichtungsoptionen	= standard
Kolbenstangenlänge (mm)	0
Zertifizierungen	= standard

Rundzylinder - Serie 27

Produktcode: 27M2A20A0015

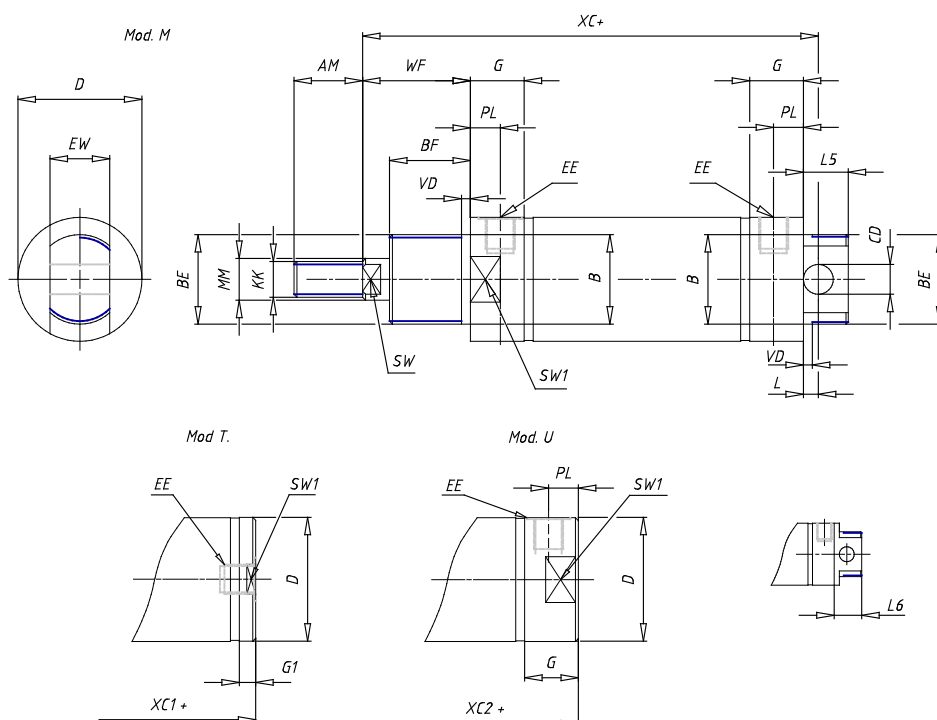

MAßE

AM (mm)	14
Ø B (mm)	16
BF (mm)	12
BE	M16x1.5
Ø CD (mm)	6
Ø D (mm)	21.5
EE	G1/8
EW (mm)	12
G (mm)	15.5
G1 (mm)	8.0
KK	M8x1.25
leicht (mm)	7
Ø MM (mm)	8
L5 (mm)	13
L6 (mm)	0
PL (mm)	9
SW (mm)	7
VD (mm)	3
WF (mm)	17.0
XC (mm)	77.0
XC1 (mm)	62.5
XC2 (mm)	70.8
SW1 (mm)	19

BG (mm)	0
BG1 (mm)	0.0
FB	0
RT	0
Ø RT1 (mm)	0
TC (mm)	0
TF (mm)	0.0