

Ventile - Serie 28

Produktcode: 2810 3/8

Datenblatt Erstellungsdatum: 21.05.26 01:11

Überprüfen Sie das aktualisierte Dokument [klicken](#)



TECHNISCHE DATEN

Mod.	2810 3/8
------	----------

Ventile - Serie 28

Produktcode: 2810 3/8

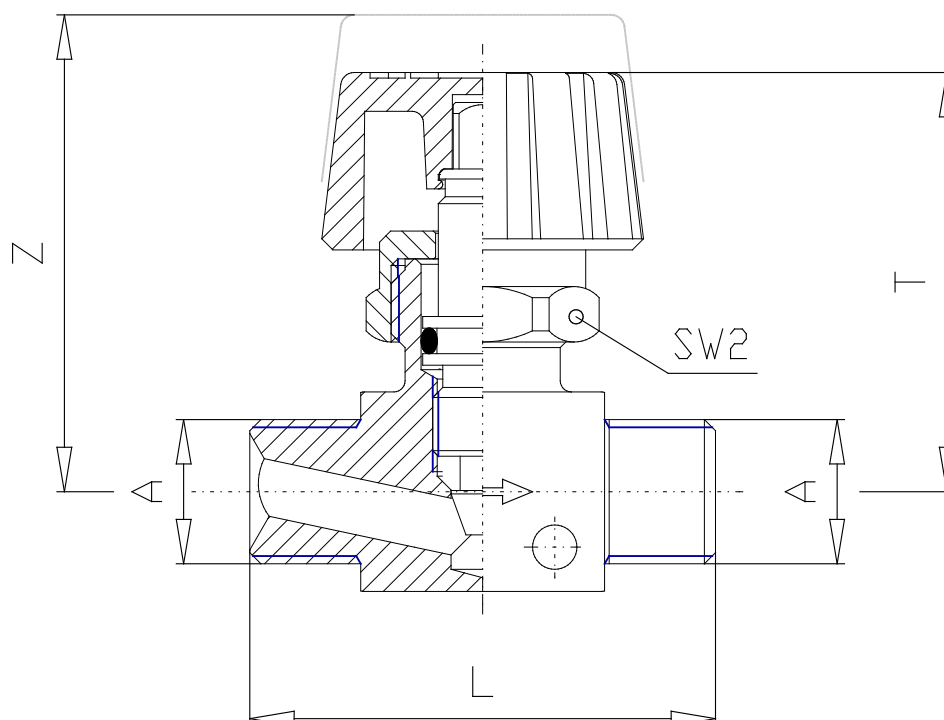

MAßE

A	G3/8
P	-
S	-
T (mm)	37.0
Z (mm)	42.5
SMAX	-
SW2	19
SW3	-