

Ventile - Serie 28

Produktcode: 2820 1/4

Datenblatt Erstellungsdatum: 20.05.26 16:50

Überprüfen Sie das aktualisierte Dokument [klicken](#)



TECHNISCHE DATEN

Mod.	2820 1/4
------	----------

Ventile - Serie 28

Produktcode: 2820 1/4

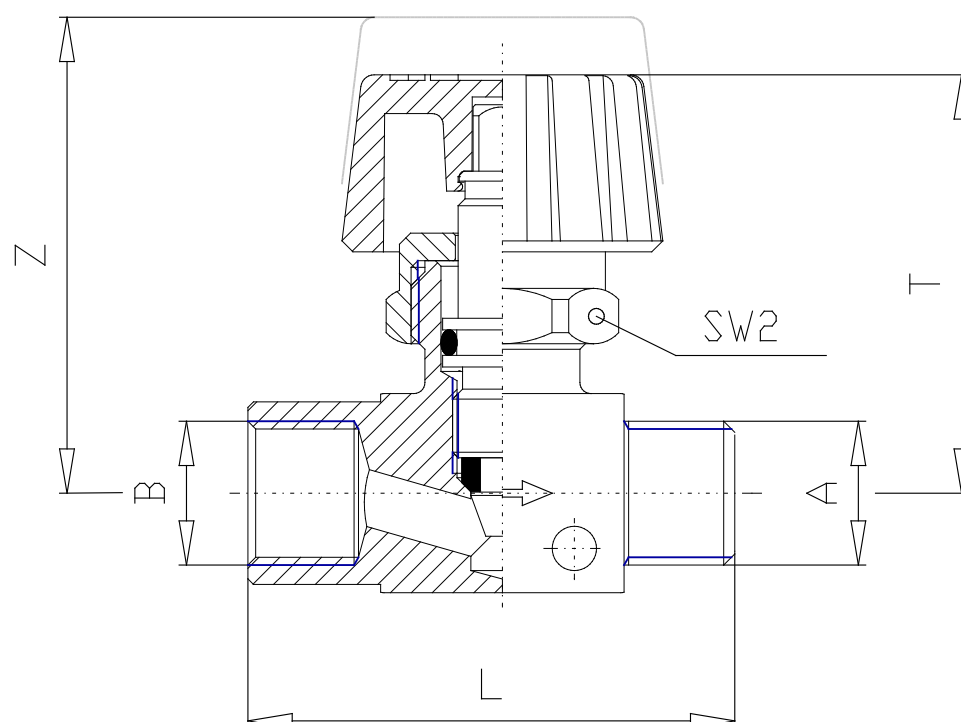

MAßE

A	G1/4
P	-
S	-
T (mm)	37.0
Z (mm)	42.5
SMAX	-
SW2	19
SW3	-