

Ventile - Serie 28

Produktcode: 2820 1/8

Datenblatt Erstellungsdatum: 21.05.26 01:12

Überprüfen Sie das aktualisierte Dokument [klicken](#)



TECHNISCHE DATEN

Mod.	2820 1/8
------	----------

Ventile - Serie 28

Produktcode: 2820 1/8

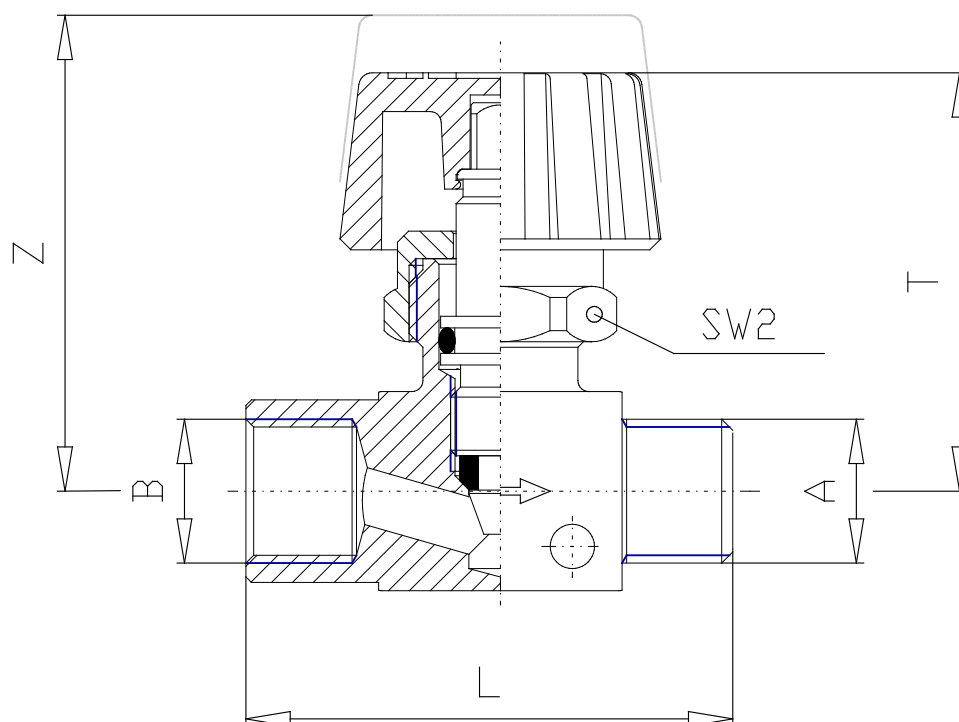

MAßE

A	G1/8
P	-
S	-
T (mm)	37.0
Z (mm)	42.5
SMAX	-
SW2	19
SW3	-