

Kompaktzylinder - Serie 31

Produktcode: 31F1A016A005

Datenblatt Erstellungsdatum: 21.05.26 04:37

Überprüfen Sie das aktualisierte Dokument  [klicken](#)



TECHNISCHE DATEN

Serie	31
Version	F = Innengewinde
Funktion	1=einfachwirkend, Feder vorn
Werkstoff	A = Kolbenstange Edelstahl gerollt 1.4305, Aluminium Profil
Diameter (mm)	16
Bauart	A = Standard
Hub (mm)	5
Dichtungsoptionen	= standard
Kolbenstangenlänge (mm)	0
Kolbenstangenlänge 2 (mm)	0
Zertifizierungen	= standard

Kompaktzylinder - Serie 31

Produktcode: 31F1A016A005

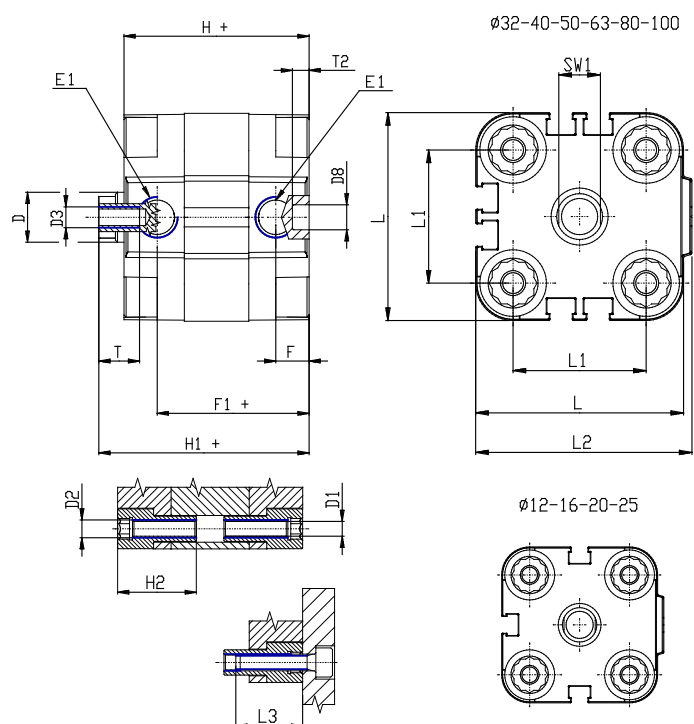

MAßE

Ø D (mm)	8
Ø D1 (mm)	3.5
D2	M4
D3	M4
Ø D4 (mm)	3
D5	M3
Ø D8 (mm)	6
D9 (mm)	5
D10 (mm)	8
E1	M5
F (mm)	8.0
F1 (mm)	30.0
H (mm)	38.0
H1 (mm)	42.5
H2 (mm)	18.5
K1	M8
L (mm)	29
L1 (mm)	18
L2 (mm)	30.0
L3 (mm)	16
L4 (mm)	9.9
t (mm)	8
T1 (mm)	20

T2 (mm)	4
SW1 (mm)	7