

## Kompaktzylinder - Serie 31

Produktcode: 31F1A020A020

Datenblatt Erstellungsdatum: 21.05.26 04:20

Überprüfen Sie das aktualisierte Dokument  [klicken](#)



### TECHNISCHE DATEN

<b>Serie</b>	31
<b>Version</b>	F = Innengewinde
<b>Funktion</b>	1=einfachwirkend, Feder vorn
<b>Werkstoff</b>	A = Kolbenstange Edelstahl gerollt 1.4305, Aluminium Profil
<b>Diameter (mm)</b>	20
<b>Bauart</b>	A = Standard
<b>Hub (mm)</b>	20
<b>Dichtungsoptionen</b>	= standard
<b>Kolbenstangenlänge (mm)</b>	0
<b>Kolbenstangenlänge 2 (mm)</b>	0
<b>Zertifizierungen</b>	= standard

## Kompaktzylinder - Serie 31

Produktcode: 31F1A020A020

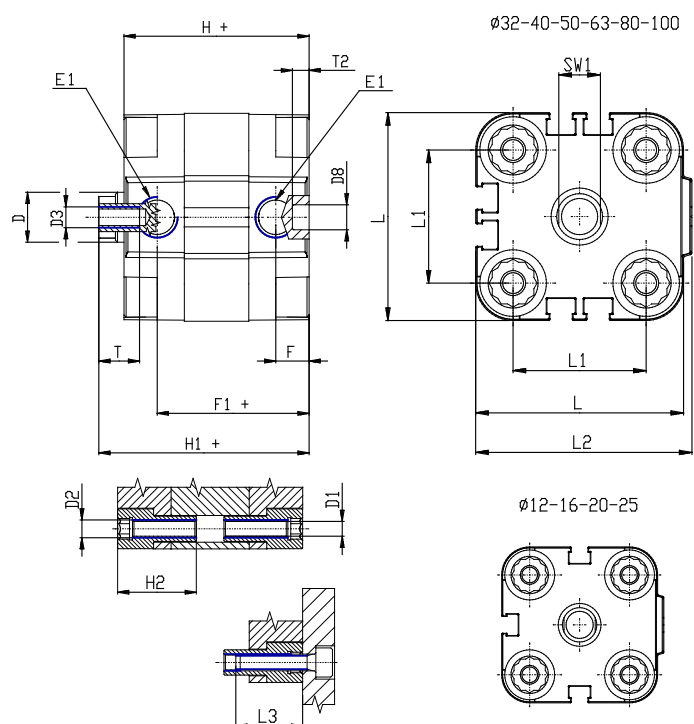

### MAßE

Ø D (mm)	10
Ø D1 (mm)	4.5
D2	M5
D3	M5
Ø D4 (mm)	4
D5	M4
Ø D8 (mm)	6
D9 (mm)	6
D10 (mm)	10
E1	M5
F (mm)	8.0
F1 (mm)	30.0
H (mm)	38.0
H1 (mm)	42.5
H2 (mm)	18.5
K1	M10x1,25
L (mm)	36
L1 (mm)	22
L2 (mm)	37.5
L3 (mm)	18
L4 (mm)	12.0
t (mm)	10
T1 (mm)	22

T2 (mm)	4
SW1 (mm)	8