

Kompaktzylinder, Mehrstellungsausführungen - Serie 31

Produktcode: 31F2A012A20/40N

Datenblatt Erstellungsdatum: 20.05.26 17:33

Überprüfen Sie das aktualisierte Dokument  [klicken](#)



TECHNISCHE DATEN

Serie	31
Version	F = Kolbenstangeninnengewinde
Funktion	2 = doppeltwirkend
Werkstoff	A = Kolbenstange Edelstahl gerollt 1.4305, Aluminium Profil
Diameter (mm)	12
Bauart	A = Standard
Segmenten	2 = 2 fach
Hubzylinder 1 (mm)	20
Hubzylinder 2 (mm)	40
Hubzylinder 3 (mm)	0
Hubzylinder 4 (mm)	0
Zertifizierungen	= standard

Kompaktzylinder, Mehrstellungsausführungen - Serie 31

Produktcode: 31F2A012A20/40N

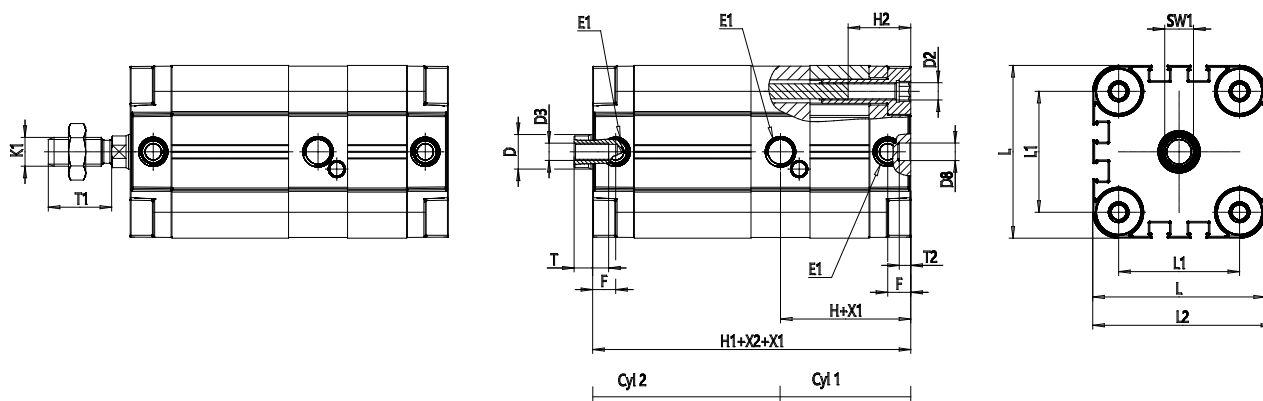

MAßE

ØD (mm)	6
ØD1 (mm)	3.5
D2	M4
D3	M3
D4 (mm)	3
D5	M3
ØD8 (mm)	6
D9 (mm)	5
D10 (mm)	6
E1	M5
F (mm)	8.0
F1 (mm)	30.0
FX (mm)	12.5
H (mm)	34.5
H1 (mm)	63.5
H2 (mm)	12.5
H3 (mm)	58.5
H4 (mm)	0.0
K1	M6
L (mm)	29
L1 (mm)	18
L2 (mm)	30.0
L3 (mm)	16

L4 (mm)	9.9
t (mm)	6
T1 (mm)	16
T2 (mm)	4
SW1 (mm)	5
SWK (mm)	6