

# Kompaktzylinder, Mehrstellungsausführungen - Serie 31

Produktcode: 31F2A016A10/50N

Datenblatt Erstellungsdatum: 20.05.26 17:32

Überprüfen Sie das aktualisierte Dokument  [klicken](#)



## TECHNISCHE DATEN

<b>Serie</b>	31
<b>Version</b>	F = Kolbenstangeninnengewinde
<b>Funktion</b>	2 = doppeltwirkend
<b>Werkstoff</b>	A = Kolbenstange Edelstahl gerollt 1.4305, Aluminium Profil
<b>Diameter (mm)</b>	16
<b>Bauart</b>	A = Standard
<b>Segmenten</b>	2 = 2 fach
<b>Hubzylinder 1 (mm)</b>	10
<b>Hubzylinder 2 (mm)</b>	50
<b>Hubzylinder 3 (mm)</b>	0
<b>Hubzylinder 4 (mm)</b>	0
<b>Zertifizierungen</b>	= standard

## Kompaktzylinder, Mehrstellungsausführungen - Serie 31

Produktcode: 31F2A016A10/50N

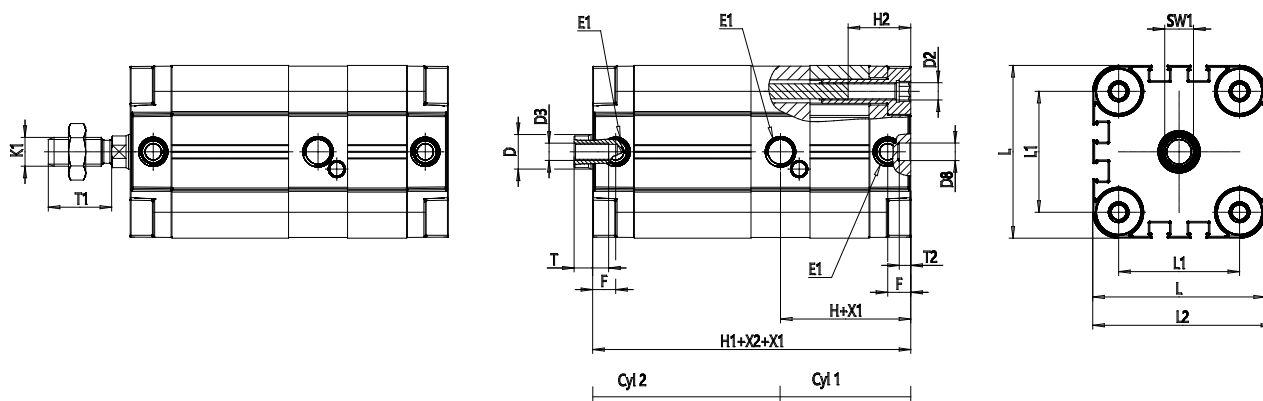

### MAßE

ØD (mm)	8
ØD1 (mm)	3.5
D2	M4
D3	M4
D4 (mm)	3
D5	M3
ØD8 (mm)	6
D9 (mm)	5
D10 (mm)	8
E1	M5
F (mm)	8.0
F1 (mm)	30.0
FX (mm)	12.5
H (mm)	34.5
H1 (mm)	63.5
H2 (mm)	12.5
H3 (mm)	62.5
H4 (mm)	0.0
K1	M8
L (mm)	29
L1 (mm)	18
L2 (mm)	30.0
L3 (mm)	16

L4 (mm)	9.9
t (mm)	8
T1 (mm)	20
T2 (mm)	4
SW1 (mm)	7
SWK (mm)	6