

Kompaktzylinder Tandemversion - Serie 32

Produktcode: 32F2A025A005N2

Datenblatt Erstellungsdatum: 21.05.26 05:31

Überprüfen Sie das aktualisierte Dokument  [klicken](#)



TECHNISCHE DATEN

Serie	32
Version	F = Kolbenstangeninnengewinde
Funktion	2 = doppeltwirkend
Werkstoff	A = Kopf, Deckel, Profilrohr AL eloxiert - Kolben AL eloxiert
Diameter (mm)	25
Bauart	A = Standard
Segmenten	2 = 2 fach
Zylinderhub (mm)	5
Zertifizierungen	= standard

Kompaktzylinder Tandemversion - Serie 32

Produktcode: 32F2A025A005N2

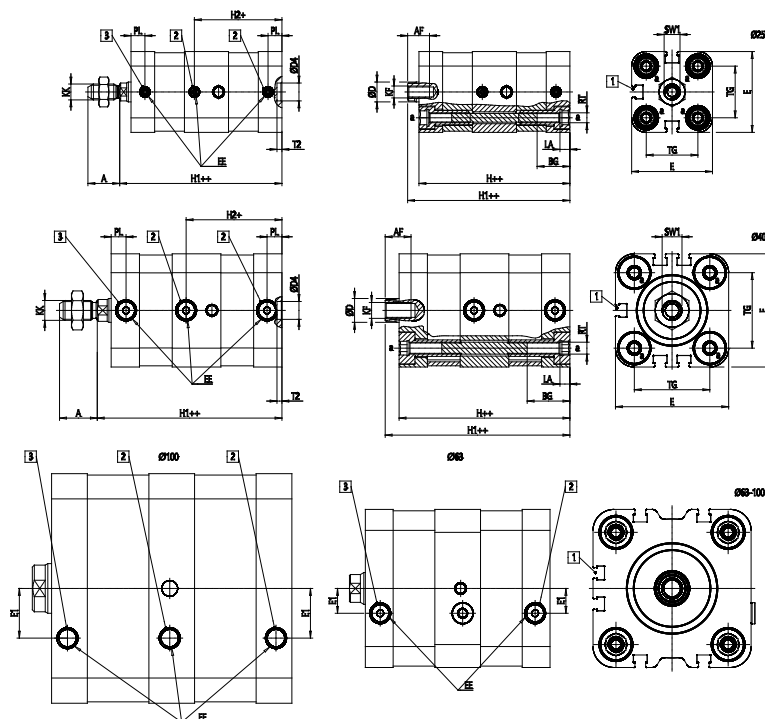

MAßE

A (mm)	16
AF (mm)	11
BG (mm)	16.5
ØD (mm)	10
D4 (mm)	9
E (mm)	40.7
EE	M5
E1 (mm)	0.0
H (mm)	76
H1 (mm)	81.7
H2 (mm)	44.0
KF	M6
KK (mm)	M8X1.25
LA (mm)	5
PL (mm)	7.0
SW1 (mm)	8
RT	M5
T2 (mm)	2.5
TG (mm)	26.0