

Elektromechanische Zylinder - Serie 3E

Produktcode: 3E020BS0050P10M

Datenblatt Erstellungsdatum: 21.05.26 12:14

Überprüfen Sie das aktualisierte Dokument  [klicken](#)



TECHNISCHE DATEN

Serie	3E
Durchmesser (mm)	020
Schraubenabstand (mm)	P10 = 10mm
Hub (mm)	50
Bauart	M = Außengewinde
längere Stange	0
Motoranschluss	nur Zylinder
Motor	
Bremse	
Encoder	
Kommunikation	
Weitere funktionen	

Elektromechanische Zylinder - Serie 3E

Produktcode: 3E020BS0050P10M

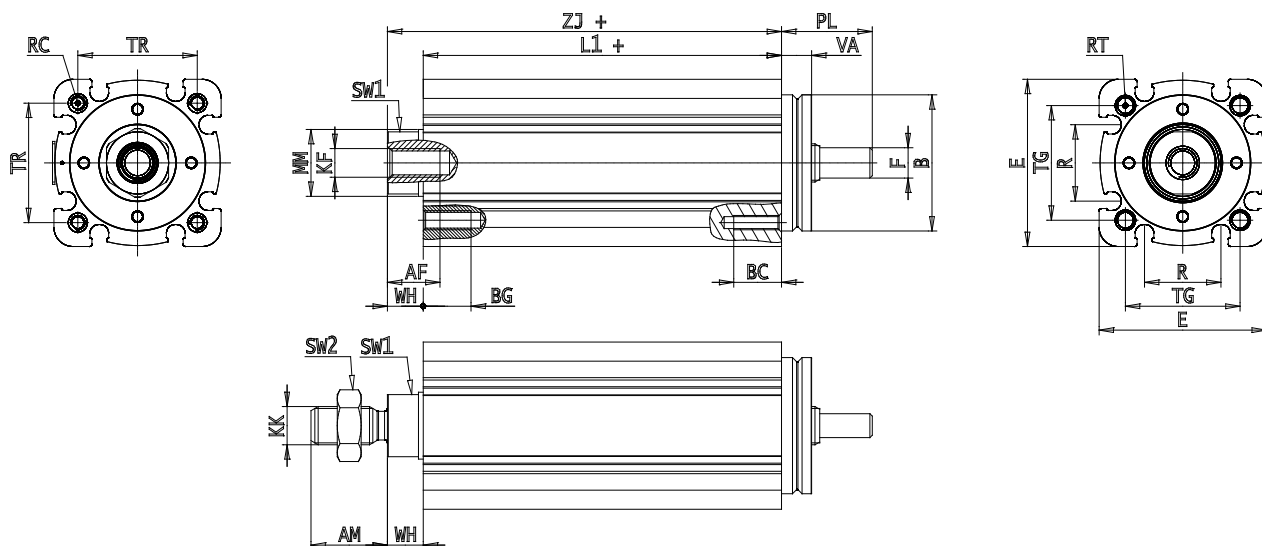

MAßE

AM (mm)	16
AF (mm)	11
B (mm)	28.5
BG (mm)	10
E (mm)	35
E2 (mm)	42.5
F (mm)	5
KF	M6
M (mm)	0
A (mm)	0
KK (mm)	M8x1.25
L1 (mm)	125
L2 (mm)	0
MM (mm)	14
R (mm)	16
RT (mm)	M4
PL (mm)	19
SW1 (mm)	13
SW2 (mm)	13
TG (mm)	24.0
VA (mm)	6.5
TR (mm)	25.0
RC	M3

BC (mm)	10
VD (mm)	2
N (mm)	2.2
WH (mm)	7.5
ZJ (mm)	132.5
ZY (mm)	0