

Zylinder ISO 15552 (ex DIN/ISO 6431 / VDMA 24562) - Serie 41K

Produktcode: 41K2P160A0050

Datenblatt Erstellungsdatum: 21.05.26 10:19

Überprüfen Sie das aktualisierte Dokument  [klicken](#)



TECHNISCHE DATEN

SERIE (Serie / mm)	41
VER (Version)	K = Standard ,Magnetversion
FUNZ (Funktion)	2 = doppeltwirkend, gedämpft
MAT (Werkstoff)	P = Kolbenstange Edelstahl gerollt 1.4028 gerollt - Rohr Aluminium eloxiert - Dichtungen NBR
PHY (Diameter / mm)	160
TYP (Bauart)	A = Standard
HUB (Hub / mm)	50
OPZIONI (Dichtungsoptionen)	= Standard
LSTELO (Kolbenstangenlänge / mm)	0
LSTELO2 (Kolbenstangenlänge 2 / mm)	0
OPZIONI2 (Schutzoptionen)	= Standard
CERTIFICAZIONI (Zertifizierung)	= Standard

Zylinder ISO 15552 (ex DIN/ISO 6431 / VDMA 24562) - Serie 41K

Produktcode: 41K2P160A0050

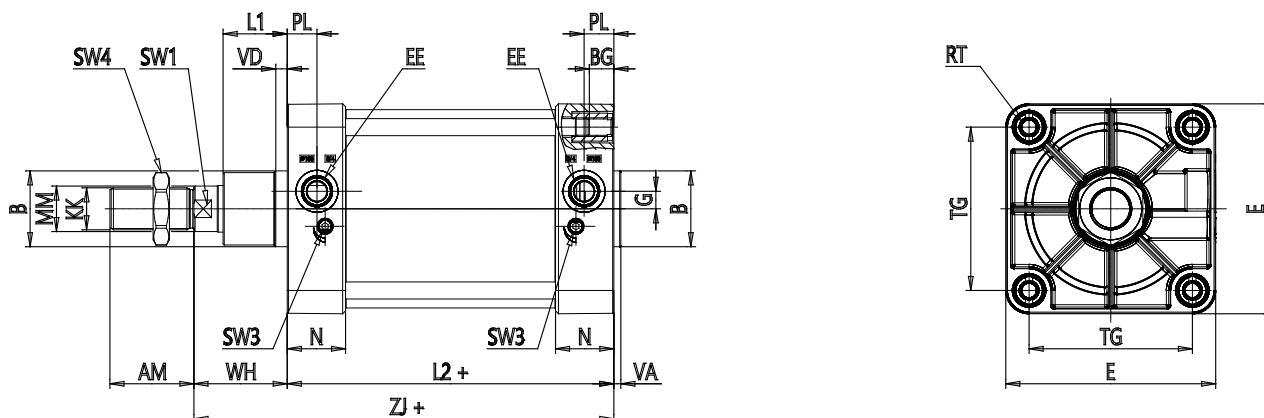

MAßE

Ø MM (mm)	40
KK	M36x2
Ø D11 (mm)	65
PL (mm)	25.5
G (mm)	15
L1 (mm)	55
AM (mm)	72
VA (mm)	6
EE	G3/4
WH (mm)	80
L2 (mm)	180
ZJ	260
VD (mm)	10
N (mm)	50
RT	M16
BG (mm)	24
TG (mm)	140
E (mm)	180
SW1 (mm)	36
SW3 (mm)	4
SW4 (mm)	55
Dämpfungsweg (mm)	33
XV1±2 (mm)	145

XV2±2 (mm)	170
XV3±2 (mm)	195
h14 (mm)	200
TK (mm)	40
e9 (mm)	32
h14 (mm)	32
UW (mm)	200