

## Zylinder ISO 15552 (ex DIN/ISO 6431 / VDMA 24562) - Serie 41K

Produktcode: 41K2P160A0125

Datenblatt Erstellungsdatum: 21.05.26 13:12

Überprüfen Sie das aktualisierte Dokument  [klicken](#)



### TECHNISCHE DATEN

<b>SERIE (Serie / mm)</b>	41
<b>VER (Version)</b>	K = Standard ,Magnetversion
<b>FUNZ (Funktion)</b>	2 = doppeltwirkend, gedämpft
<b>MAT (Werkstoff)</b>	P = Kolbenstange Edelstahl gerollt 1.4028 gerollt - Rohr Aluminium eloxiert - Dichtungen NBR
<b>PHY (Diameter / mm)</b>	160
<b>TYP (Bauart)</b>	A = Standard
<b>HUB (Hub / mm)</b>	125
<b>OPZIONI (Dichtungsoptionen)</b>	= Standard
<b>LSTELO (Kolbenstangenlänge / mm)</b>	0
<b>LSTELO2 (Kolbenstangenlänge 2 / mm)</b>	0
<b>OPZIONI2 (Schutzoptionen)</b>	= Standard
<b>CERTIFICAZIONI (Zertifizierung)</b>	= Standard

## Zylinder ISO 15552 (ex DIN/ISO 6431 / VDMA 24562) - Serie 41K

Produktcode: 41K2P160A0125

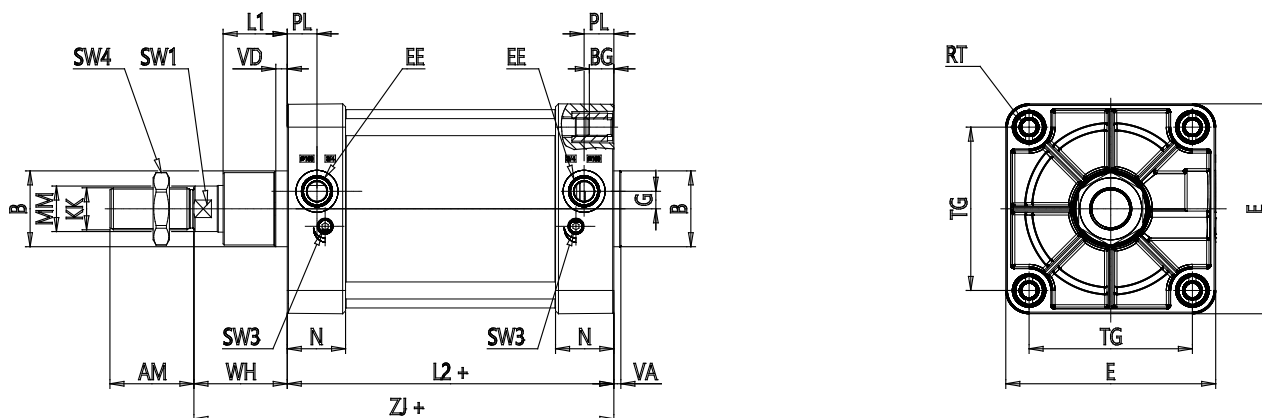

### MAßE

Ø MM (mm)	40
KK	M36x2
Ø D11 (mm)	65
PL (mm)	25.5
G (mm)	15
L1 (mm)	55
AM (mm)	72
VA (mm)	6
EE	G3/4
WH (mm)	80
L2 (mm)	180
ZJ	260
VD (mm)	10
N (mm)	50
RT	M16
BG (mm)	24
TG (mm)	140
E (mm)	180
SW1 (mm)	36
SW3 (mm)	4
SW4 (mm)	55
Dämpfungsweg (mm)	33
XV1±2 (mm)	145

XV2±2 (mm)	170
XV3±2 (mm)	195
h14 (mm)	200
TK (mm)	40
e9 (mm)	32
h14 (mm)	32
UW (mm)	200