

## Elektromechanische Achsen mit Schrauben - Serie 5E-SBS

Produktcode: 5ES050BS05P0350AS1

Datenblatt Erstellungsdatum: 21.05.26 16:12

Überprüfen Sie das aktualisierte Dokument  [klicken](#)



### TECHNISCHE DATEN

<b>Serie</b>	5E
<b>Baugröße</b>	S = quadratischer Querschnitt
<b>Größe</b>	050
<b>Bauart</b>	BS = Kugelgewindetrieb
<b>Schraubensteigung</b>	05P = 5mm
<b>Hub (mm)</b>	350
<b>Version</b>	A = Standardachse
<b>Schlitten-typ</b>	S = Standard
<b>Anzahl schlitten</b>	1 = 1 Schieber

# Elektromechanische Achsen mit Schrauben - Serie 5E-SBS

Produktcode: 5ES050BS05P0350AS1

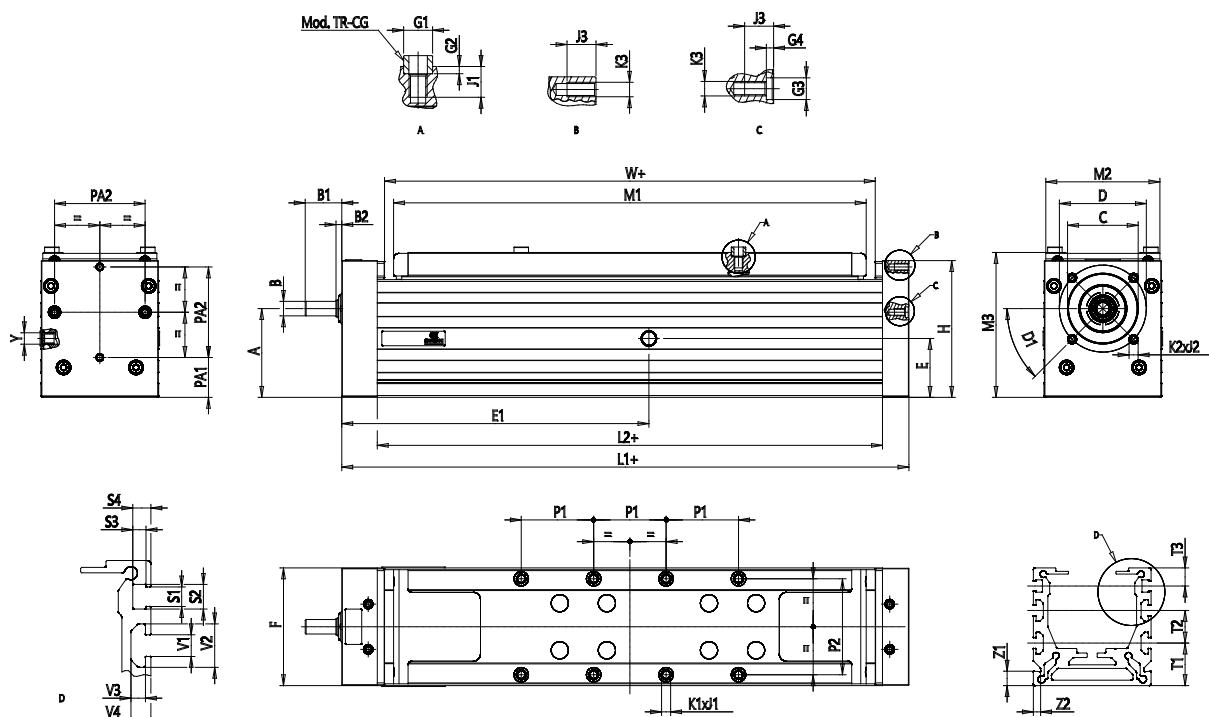

## MAßE

A (mm)	36.7
B (H7) (mm)	8
B1 (mm)	22.3
B2 (mm)	5.3
C (mm)	30
D (mm)	38
D1 (°)	90
E (mm)	32
E1 (mm)	141.0
F (mm)	50
G1(H8) (mm)	6
G2 (mm)	2
G3 (mm)	6
G4 (mm)	2
H (mm)	60.5
L1 (mm)	264
L2 (mm)	232.0
M1 (mm)	214
M2 (mm)	48
M3 (mm)	65
P1 (mm)	30
P2 (mm)	40
PA1 (mm)	17

PA2 (mm)	40
K1	M4
J1 (mm)	8
K2	M4
J2 (mm)	6
K3	M4
J3 (mm)	6
T1 (mm)	20.0
T2 (mm)	0
T3 (mm)	10
V (mm)	6
Y	6.3
W (mm)	224.0
Z1 (mm)	8
Z2 (mm)	4
Gewicht bei Hub Null (kg)	2.00
Hubgewicht pro Meter (kg)	4.07