

## Drehzylinder - Serie 69

Produktcode: 69-032/130-M

Datenblatt Erstellungsdatum: 20.05.26 23:54

Überprüfen Sie das aktualisierte Dokument  [klicken](#)



### TECHNISCHE DATEN

<b>Serie</b>	69
<b>Kolbendurchmesser (mm)</b>	32
<b>Drehung (°)</b>	130
<b>Wellenausführung</b>	M = Zapfenwelle
<b>Werkstoff dichtungen</b>	= NBR

## Drehzylinder - Serie 69

Produktcode: 69-032/130-M

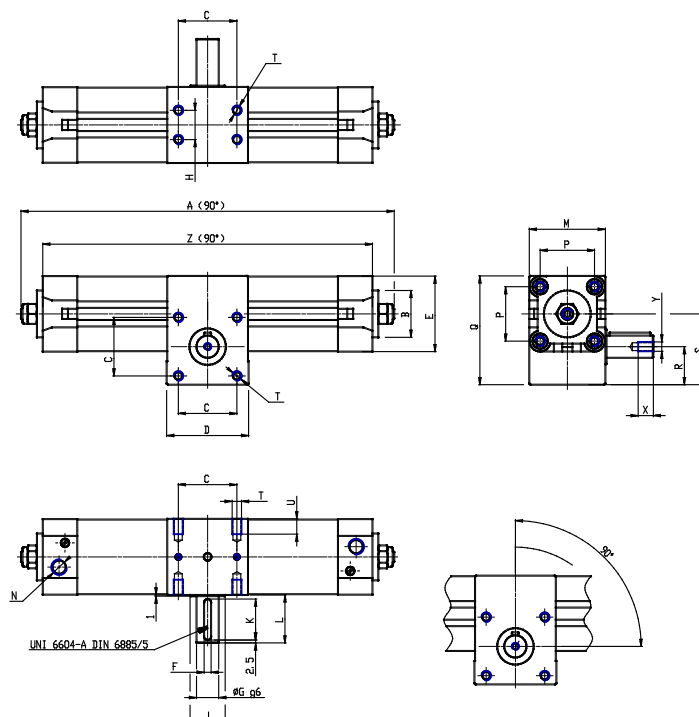

### MAßE

A (mm)	269.9
B d11 (mm)	30
C (mm)	33
D (mm)	50
E (mm)	46.0
F (mm)	5
G (mm)	14
H (mm)	18
J (mm)	25
K (mm)	25
leicht (mm)	31
mittel (mm)	50
N	G1/8
P (mm)	32.5
Q (mm)	71.5
R (mm)	25.0
S (mm)	46.5
t	M6
U (mm)	10
V (mm)	16.3
W (mm)	14
Y	M5
X (mm)	12.5
Z (mm)	239.9