

Edelstahl - Minizylinder Cetop RP52-P DIN/ISO 6432 - Serie 94 e 95

Produktcode: 94N1A16A030

Datenblatt Erstellungsdatum: 21.05.26 13:28

Überprüfen Sie das aktualisierte Dokument  [klicken](#)



TECHNISCHE DATEN

Serie	94
Version	N= Standard
Funktion	1=einfachwirkend, Feder vorn
Werkstoff	A = Edelstahl AISI 316 (SS 2343), Dichtungen NBR
Diameter (mm)	16
Bauart	A = Standard
Hub (mm)	30
Kolbenstangendichtung Viton	-
Kolbenstangenlänge (mm)	0

Edelstahl - Minizylinder Cetop RP52-P DIN/ISO 6432 - Serie 94 e 95

Produktcode: 94N1A16A030

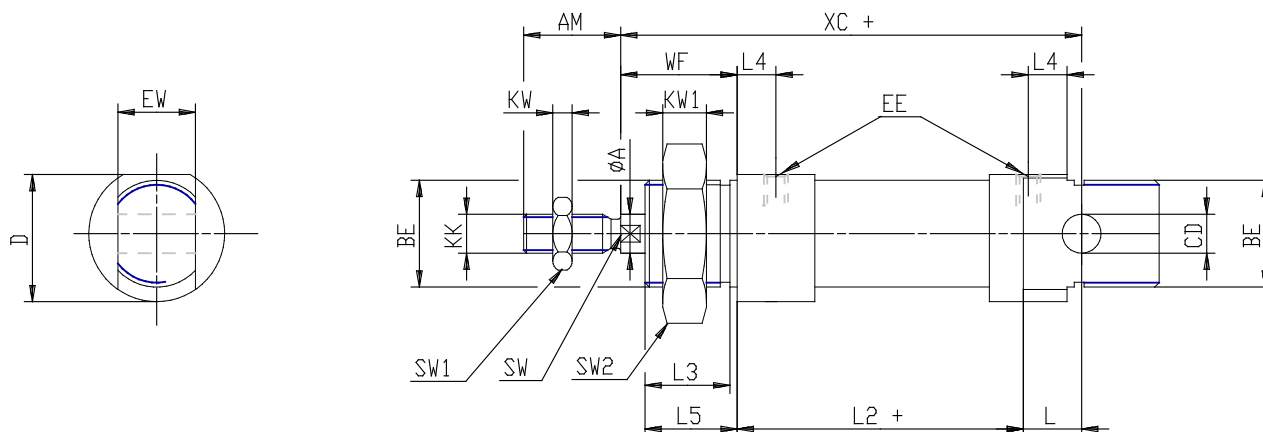

MAßE

A (mm)	6
AM (mm)	16
BE	M16x1,5
Ø CD (mm)	6
D (mm)	21.2
EE	M5
EW (mm)	12
KK	M6x1
KW (mm)	4
(mm)	5
leicht (mm)	9
L1 (mm)	100
L2 (mm)	51
L3 (mm)	14.0
L4 (mm)	5.5
L5 (mm)	15
SW (mm)	5
WF (mm)	22
XC (mm)	82