

Edelstahl - Minizylinder Cetop RP52-P DIN/ISO 6432 - Serie 94 e 95

Produktcode: 94N1A20A025

Datenblatt Erstellungsdatum: 21.05.26 00:44

Überprüfen Sie das aktualisierte Dokument  [klicken](#)



TECHNISCHE DATEN

Serie	94
Version	N= Standard
Funktion	1=einfachwirkend, Feder vorn
Werkstoff	A = Edelstahl AISI 316 (SS 2343), Dichtungen NBR
Diameter (mm)	20
Bauart	A = Standard
Hub (mm)	25
Kolbenstangendichtung Viton	-
Kolbenstangenlänge (mm)	0

Edelstahl - Minizylinder Cetop RP52-P DIN/ISO 6432 - Serie 94 e 95

Produktcode: 94N1A20A025

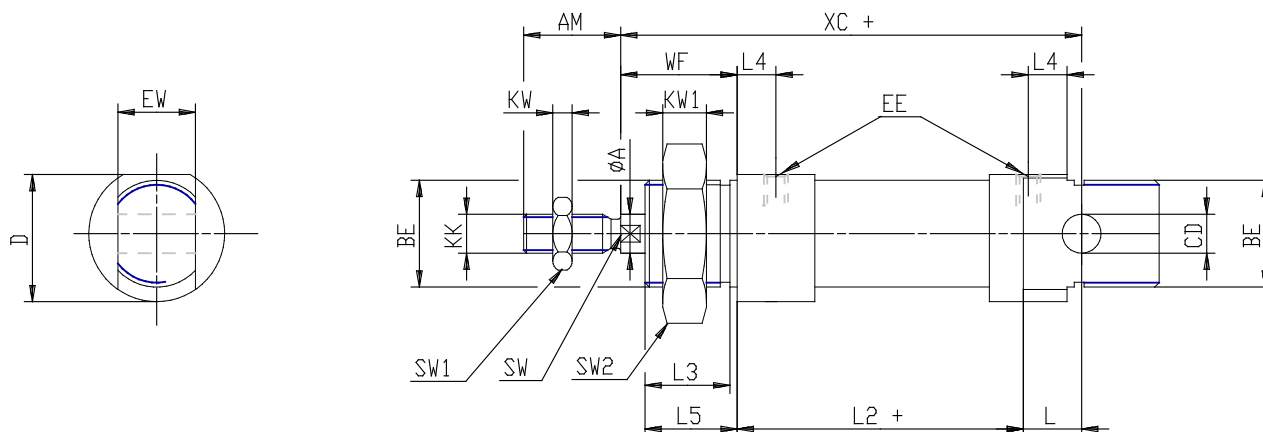

MAßE

A (mm)	8
AM (mm)	20
BE	M22x1,5
Ø CD (mm)	8
D (mm)	26.2
EE	G1\8
EW (mm)	16
KK	M8x1,25
KW (mm)	5
(mm)	5
leicht (mm)	12
L1 (mm)	116
L2 (mm)	59
L3 (mm)	17.5
L4 (mm)	8.0
L5 (mm)	19
SW (mm)	7
WF (mm)	24
XC (mm)	95