

Fußhalter - Mod. B-6E

Produktcode: B-6E-32

Datenblatt Erstellungsdatum: 21.05.26 09:45

Überprüfen Sie das aktualisierte Dokument  [klicken](#)



TECHNISCHE DATEN

Mod.	B-6E-32
------	---------

Fußhalter - Mod. B-6E

Produktcode: B-6E-32

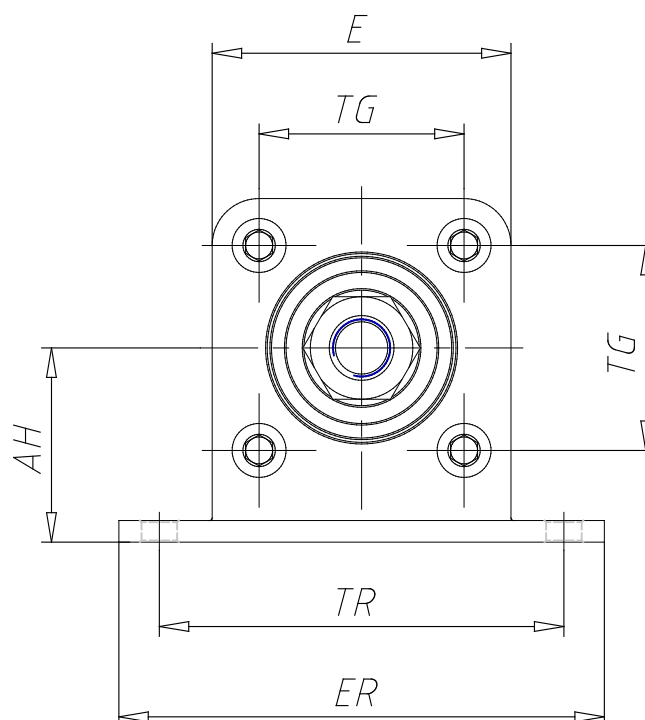

MAßE

SA (mm)	164
XA (mm)	174.5
AH (mm)	32
TG (mm)	32.5
TR (mm)	65
AT (mm)	4
AU (mm)	19.5
AO (mm)	12.5
AB (mm)	6.6
ER (mm)	79
E (mm)	46.5
Gewicht (g)	275