

Montagezubehör - Mod. C-CGP

Produktcode: C-CGP-20

Datenblatt Erstellungsdatum: 21.05.26 09:34

Überprüfen Sie das aktualisierte Dokument  [klicken](#)



TECHNISCHE DATEN

Mod. (mm)	C-CGP-20
-----------	----------

Montagezubehör - Mod. C-CGP

Produktcode: C-CGP-20

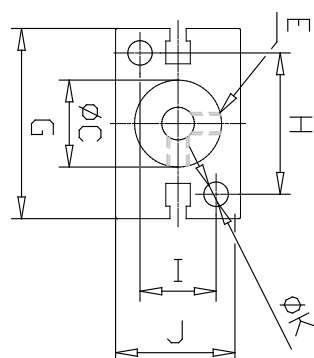
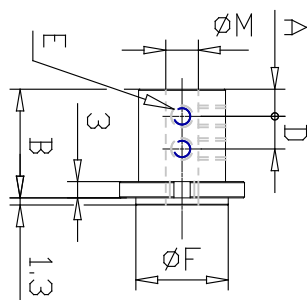

MAßE

A (mm)	7
B (mm)	25.5
C (mm)	20
D (mm)	7
E	M4
F (mm)	21
G (mm)	46
H (mm)	35
I (mm)	16
J (mm)	27
K (mm)	5.5
M (mm)	8