

## Montagezubehör - Mod. C-CGP

Produktcode: C-CGP-25

Datenblatt Erstellungsdatum: 21.05.26 09:33

Überprüfen Sie das aktualisierte Dokument [klicken](#)



### TECHNISCHE DATEN

Mod. (mm)	C-CGP-25
-----------	----------

## Montagezubehör - Mod. C-CGP

Produktcode: C-CGP-25

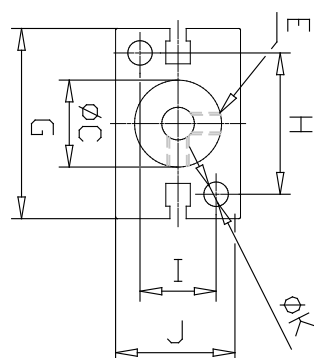
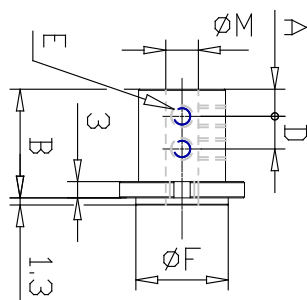

### MAßE

<b>A (mm)</b>	8
<b>B (mm)</b>	30.5
<b>C (mm)</b>	25
<b>D (mm)</b>	10
<b>E</b>	M4
<b>F (mm)</b>	26
<b>G (mm)</b>	53
<b>H (mm)</b>	40
<b>I (mm)</b>	20
<b>J (mm)</b>	33
<b>K (mm)</b>	6.6
<b>M (mm)</b>	10