

Adapter Selbst-ausgleichend - Mod. CF-50

Produktcode: CF-50-32

Datenblatt Erstellungsdatum: 21.05.26 09:30

Überprüfen Sie das aktualisierte Dokument  [klicken](#)



TECHNISCHE DATEN

Mod.	CF-50-32
------	----------

Adapter Selbst-ausgleichend - Mod. CF-50

Produktcode: CF-50-32

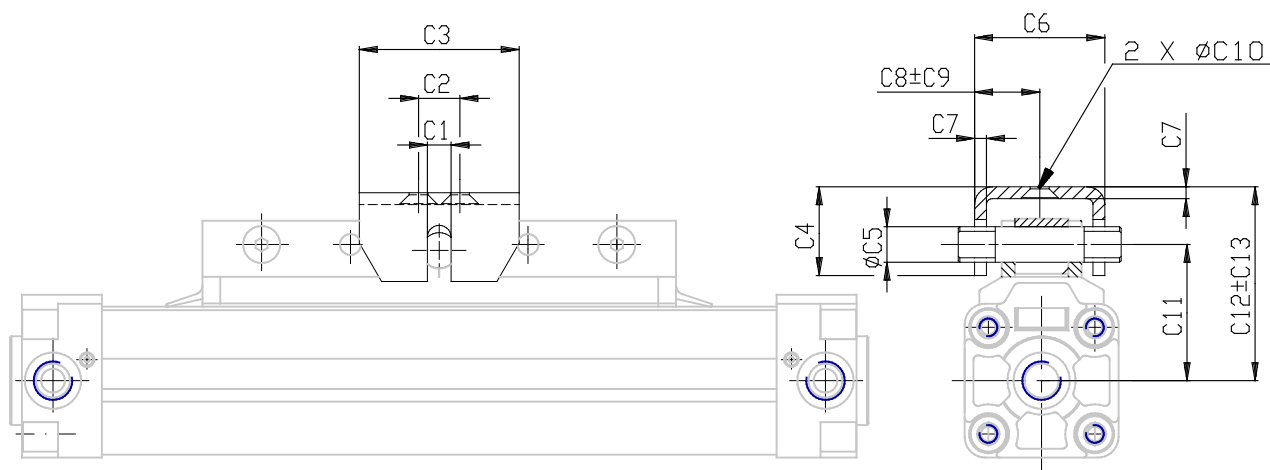

MAßE

C1 (mm)	9.3
C2 (mm)	50
C3 (mm)	76.4
C4 (mm)	27.4
C5 (mm)	11.9
C6 (mm)	38.1
C7 (mm)	3.8
C8 (mm)	19.0
C9 (mm)	1.7
C10 (mm)	7.1
C11 (mm)	48
C12 (mm)	69.4
C13 (mm)	5.5