

Endmodul - Serie 3

Produktcode: CNVL-4H3

Datenblatt Erstellungsdatum: 20.05.26 16:54

Überprüfen Sie das aktualisierte Dokument [klicken](#)



TECHNISCHE DATEN

Mod.	CNVL-4H3
------	----------

Endmodul - Serie 3

Produktcode: CNVL-4H3

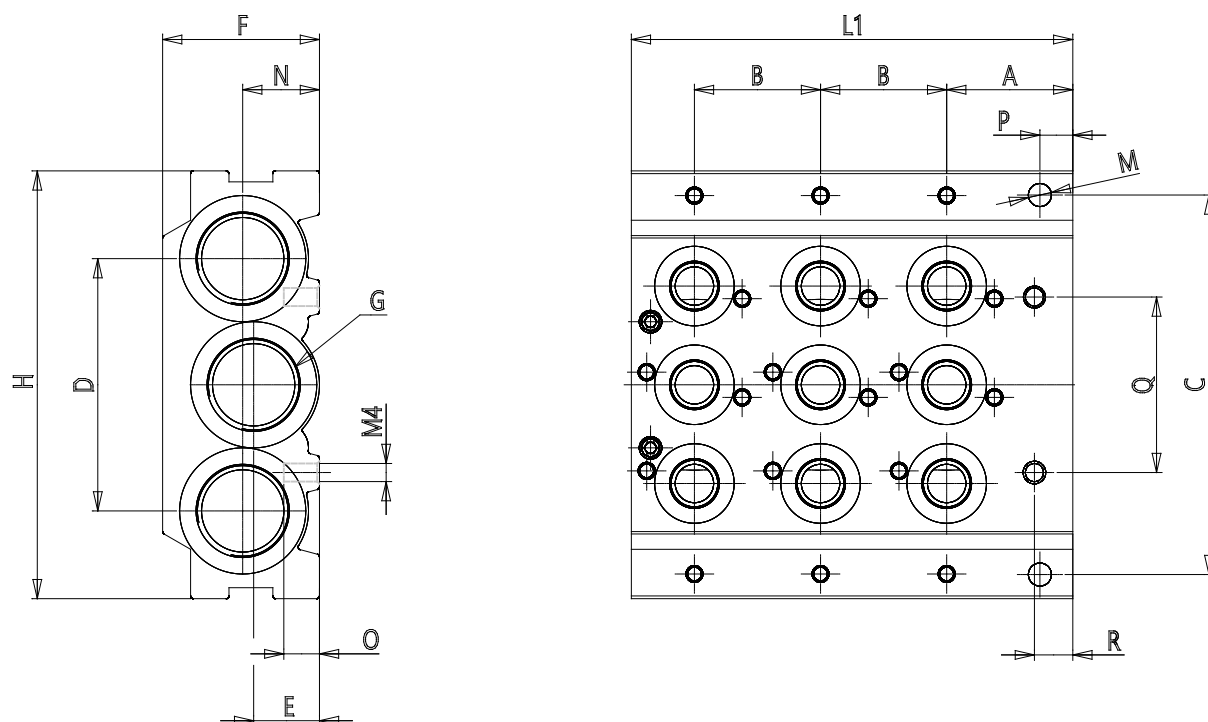

MAßE

A (mm)	26
B (mm)	26
C (mm)	88.0
D (mm)	60
E (mm)	14
F (mm)	29
H (mm)	98
L1 (mm)	91.0
M (mm)	4.3
N (mm)	14
O (mm)	5
P (mm)	5
Q (mm)	38
R (mm)	7
G	1/2