

Elastomergelenk mit Anschlüssen - Serie CO

Produktcode: COE-10-0800-1000-A

Datenblatt Erstellungsdatum: 21.05.26 09:44

Überprüfen Sie das aktualisierte Dokument  [klicken](#)



TECHNISCHE DATEN

Serie	COE
Größe	10
Durchmesser 1 (mm)	0800= 8.00mm
Durchmesser 2 (mm)	1000= 10.00mm
Härte	A= 98 Sh A

Elastomergelenk mit Anschlüssen - Serie CO

Produktcode: COE-10-0800-1000-A

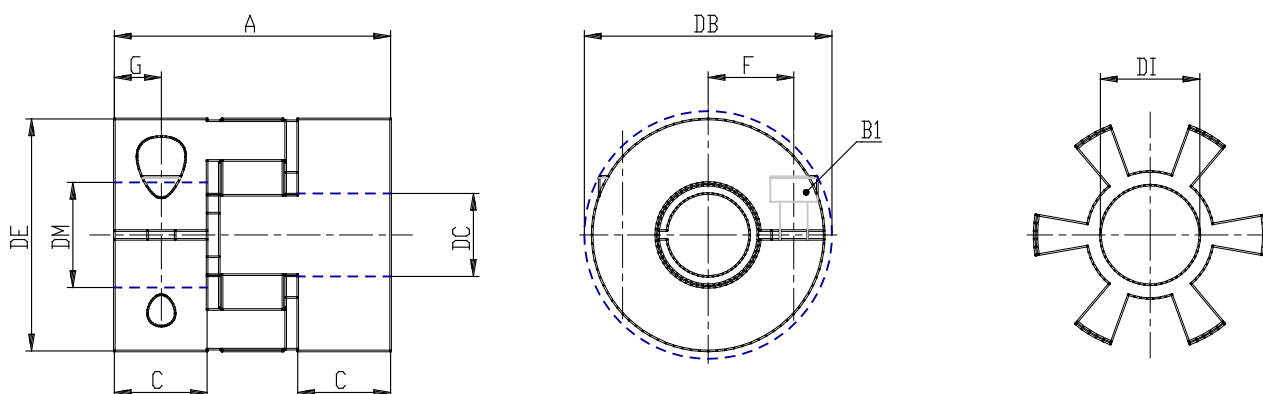

MAßE

DE (mm)	32
DB (mm)	32.0
DI (mm)	14.2
A (mm)	32
C (mm)	10.3
F (mm)	10.5
G (mm)	5.0
B1 (mm)	M4 (CH3)
Drehmoment (nm)	4
P (g)	50