

Elastomergelenk mit Anschlüssen - Serie CO

Produktcode: COE-10-1200-1400-A

Datenblatt Erstellungsdatum: 21.05.26 02:06

Überprüfen Sie das aktualisierte Dokument  [klicken](#)



TECHNISCHE DATEN

Serie	COE
Größe	10
Durchmesser 1 (mm)	1200= 12.00mm
Durchmesser 2 (mm)	1400= 14.00mm
Härte	A= 98 Sh A

Elastomergelenk mit Anschlüssen - Serie CO

Produktcode: COE-10-1200-1400-A

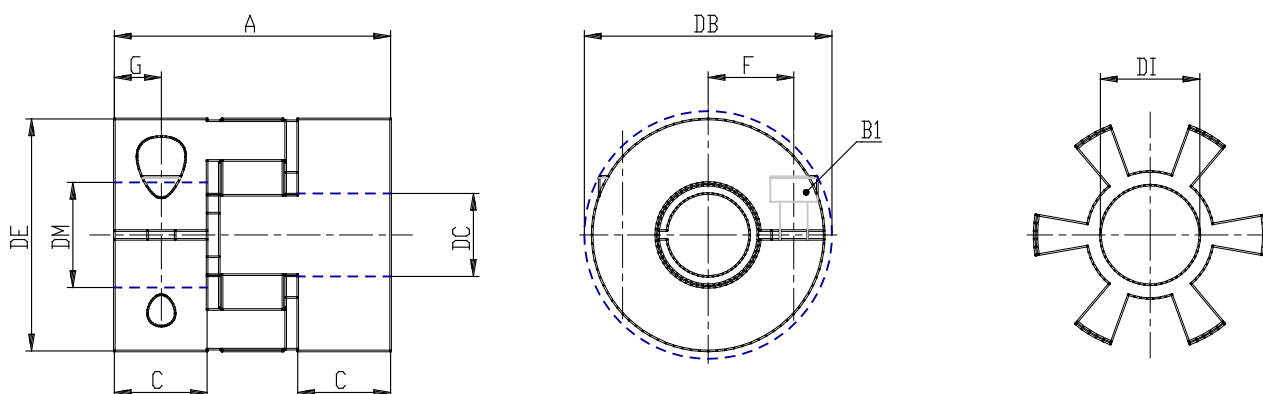

MAßE

DE (mm)	32
DB (mm)	32.0
DI (mm)	14.2
A (mm)	32
C (mm)	10.3
F (mm)	10.5
G (mm)	5.0
B1 (mm)	M4 (CH3)
Drehmoment (nm)	4
P (g)	50