

Subbase - Serie CP-CPN

Produktcode: CP-S7

Datenblatt Erstellungsdatum: 21.05.26 11:46

Überprüfen Sie das aktualisierte Dokument [klicken](#)



TECHNISCHE DATEN

Mod.	CP-S7
------	-------

Subbase - Serie CP-CPN

Produktcode: CP-S7

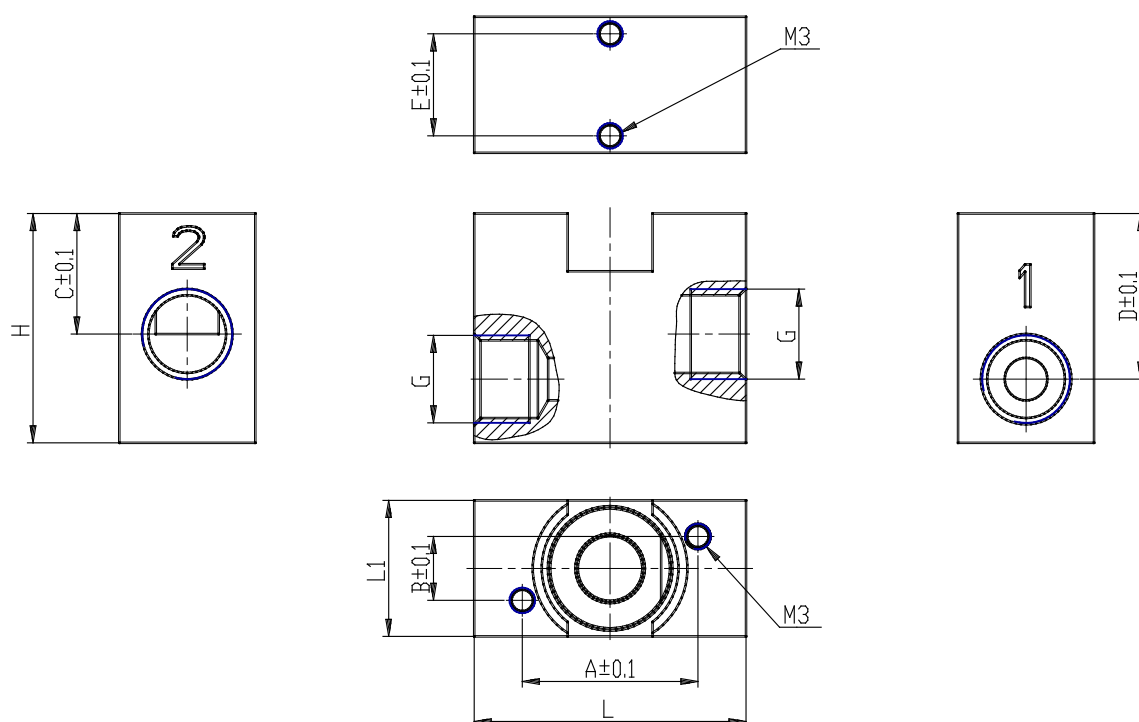

MAßE

A (mm)	25.20
B (mm)	8.00
C (mm)	14.0
D (mm)	22.5
E (mm)	15
G (mm)	1/4 G
H (mm)	31.5
L (mm)	45
L1 (mm)	22