

Flansch vorn und hinten - Mod. D-E

Produktcode: D-E-41-50

Datenblatt Erstellungsdatum: 20.05.26 17:05

Überprüfen Sie das aktualisierte Dokument  [klicken](#)

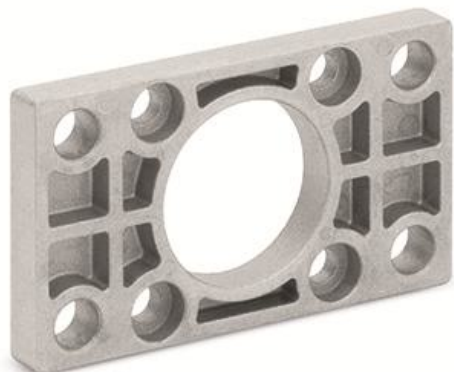

TECHNISCHE DATEN

Mod.	D-E-41-50
------	-----------

Flansch vorn und hinten - Mod. D-E

Produktcode: D-E-41-50

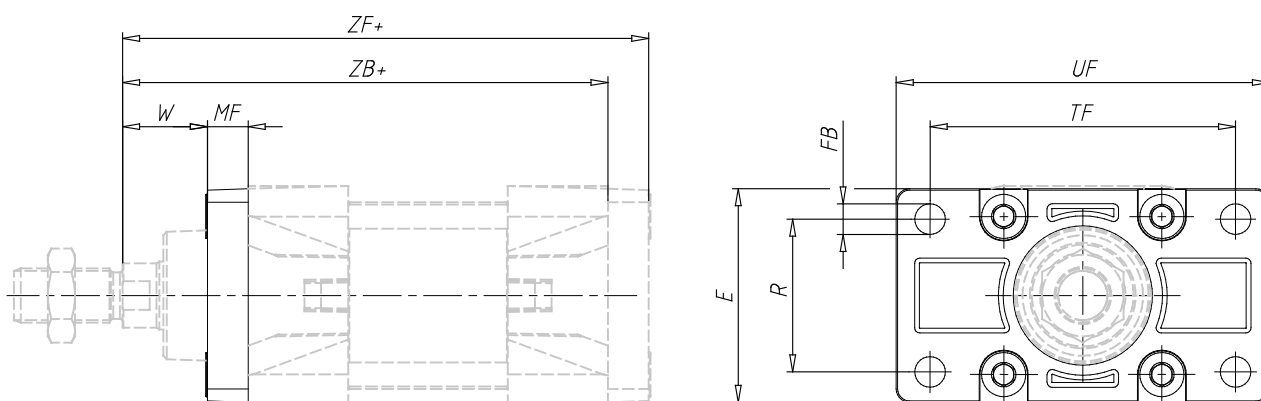

MAßE

W (mm)	25
MF (mm)	12
ZB (mm)	143
TF (mm)	90
R (mm)	45
UF (mm)	110
E (mm)	65
FB H13 (mm)	9.0
ZF (mm)	155
Drehmoment	13 Nm
PF	1