

Flansch - Mod. DC-32

Produktcode: DC-32-32

Datenblatt Erstellungsdatum: 21.05.26 09:45

Überprüfen Sie das aktualisierte Dokument  [klicken](#)

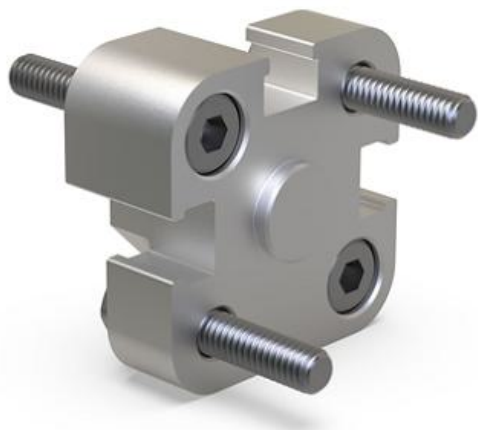

TECHNISCHE DATEN

Mod.	DC-32-32
------	----------

Flansch - Mod. DC-32

Produktcode: DC-32-32

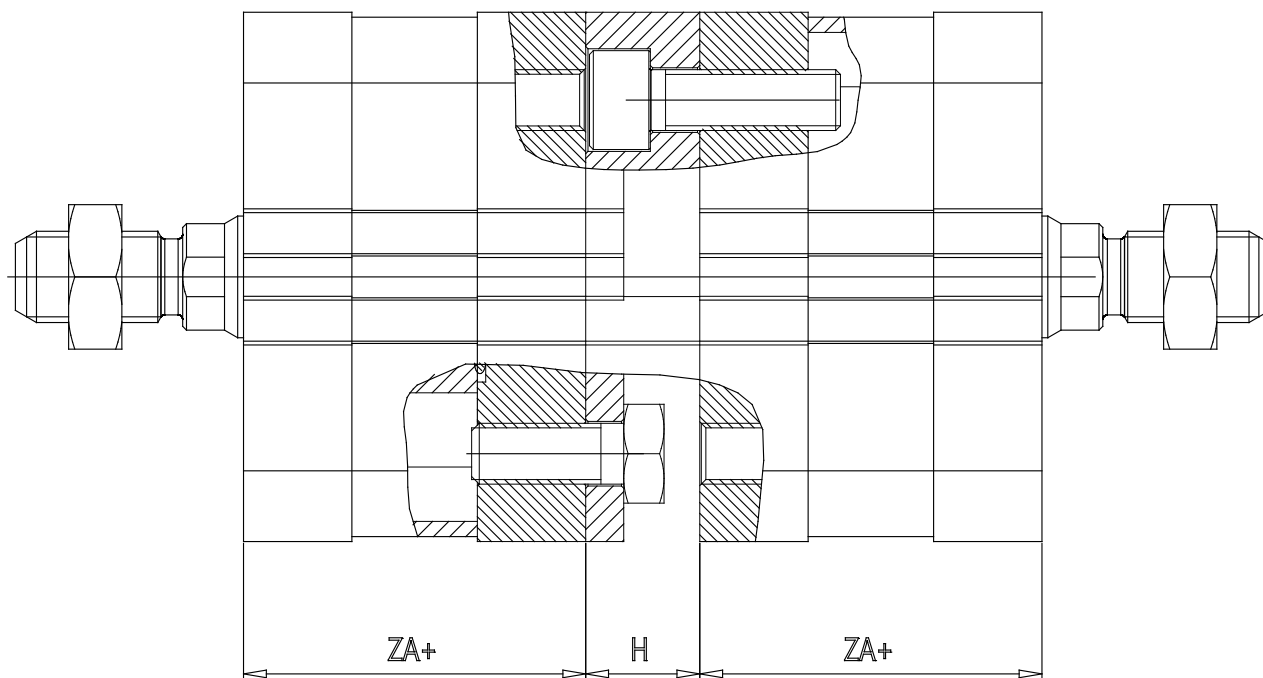

MAßE

ZA+ (mm)	44.0
H (mm)	15.0