

Planetengetriebe in Linie - Mod.GB D

Produktcode: GB-040-05-D-0024

Datenblatt Erstellungsdatum: 21.05.26 02:06

Überprüfen Sie das aktualisierte Dokument  [klicken](#)



TECHNISCHE DATEN

DS (mm)	10
LS (mm)	26
DC (mm)	26
LC (mm)	2
CC (mm)	34
TC x Tiefe	M4 x 6
EA (mm)	67.5
EB (mm)	60
DG (mm)	40
DM (mm)	8
CM (mm)	66.7
TM x Tiefe	M4 x 10
Gewicht (kg)	0.35

Planetengetriebe in Linie - Mod.GB D

Produktcode: GB-040-05-D-0024

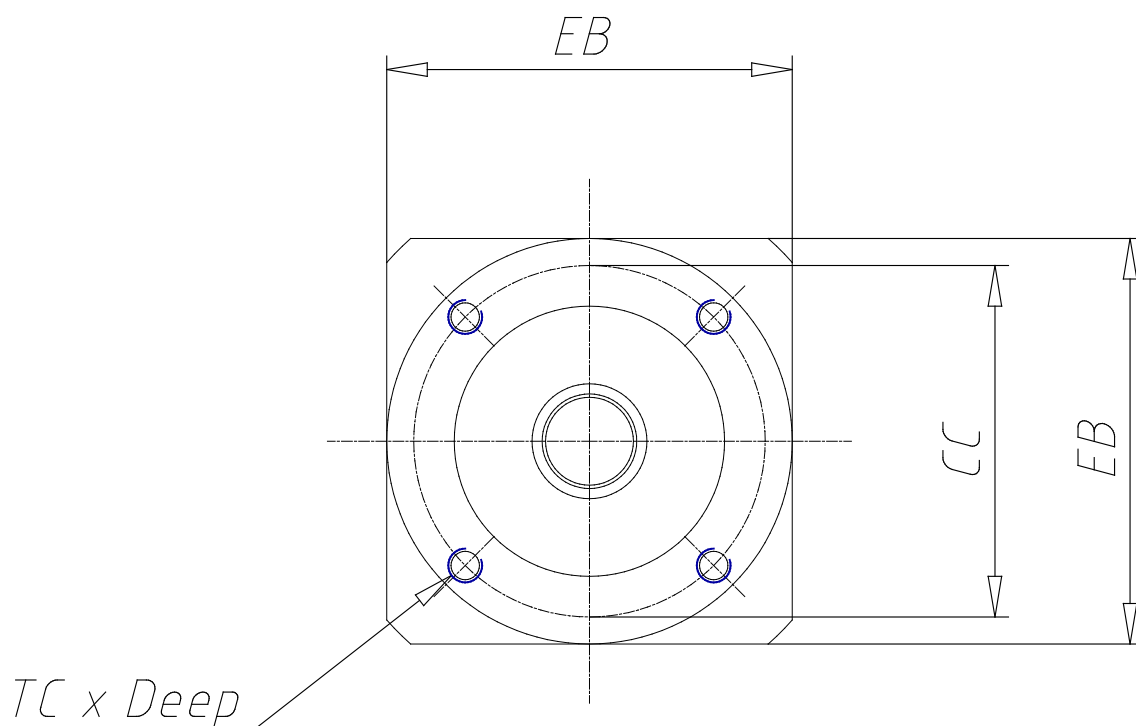

MAßE

DS (mm)	10
LS (mm)	26
DC (mm)	26
LC (mm)	2
CC (mm)	34
TC x Tiefe	M4 x 6
EA (mm)	67.5
EB (mm)	60
DG (mm)	40
DM (mm)	8
CM (mm)	66.7
TM x Tiefe	M4 x 10
Gewicht (kg)	0.35