

Schwenkgabel vorne - Mod. H e C-H

Produktcode: H-60-63

Datenblatt Erstellungsdatum: 20.05.26 17:10

Überprüfen Sie das aktualisierte Dokument  [klicken](#)



TECHNISCHE DATEN

Mod.	H-60-63
------	---------

Schwenkgabel vorne - Mod. H e C-H

Produktcode: H-60-63

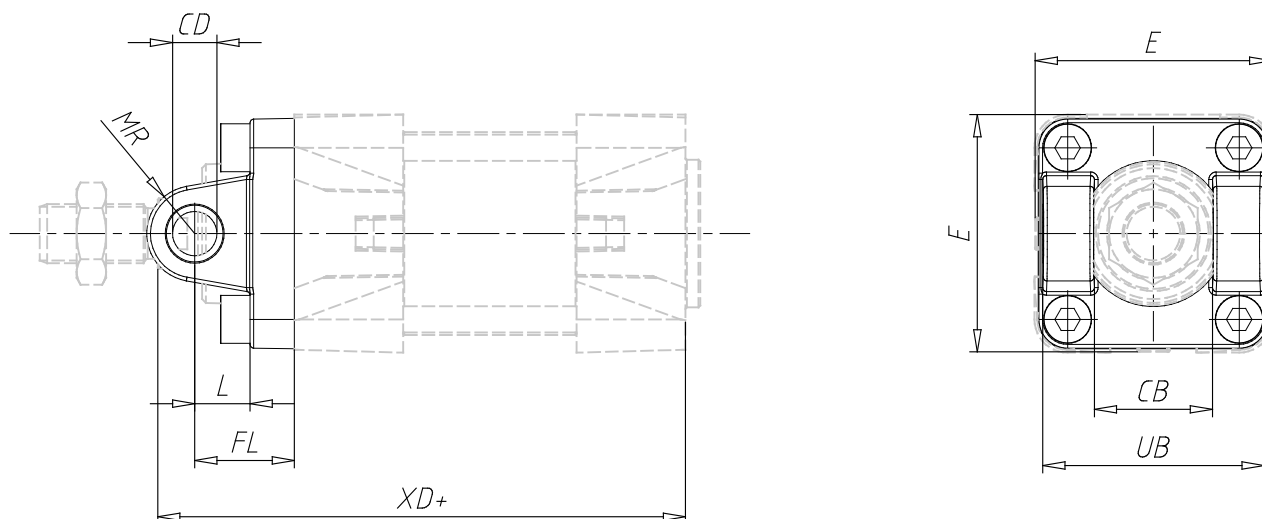

MAßE

CB (mm)	40.0
UB (mm)	70.0
E (mm)	74.0
XD (mm)	158
FL (mm)	32
leicht (mm)	21.0
CD (mm)	16
MR (mm)	16
Drehmoment	10 Nm