

Filterregler - Serie MC

Produktcode: MC104-D00-4

Datenblatt Erstellungsdatum: 21.05.26 01:25

Überprüfen Sie das aktualisierte Dokument [klicken](#)



TECHNISCHE DATEN

Mod.	MC104-D00-4
U	G1/4

Filterregler - Serie MC

Produktcode: MC104-D00-4

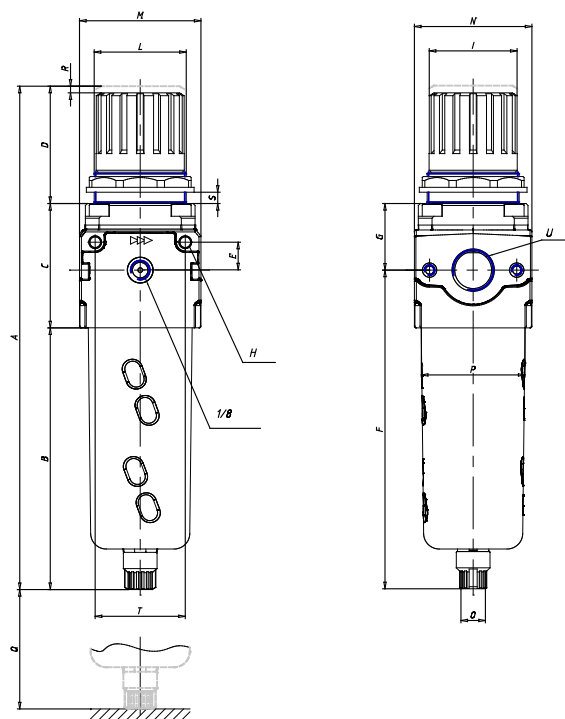

MAßE

A (mm)	190.5
B (mm)	102
C (mm)	52
D (mm)	38
E (mm)	11
F (mm)	126.5
G (mm)	27.5
H (mm)	4.5
I (mm)	28
L	30x1.5
M (mm)	45
N (mm)	45
O	G1/8
P (mm)	37
Q (mm)	58
R (mm)	3.0
S	0:6
T (mm)	35