

## Druckregler - Serie MC

Produktcode: MC104-R10

Datenblatt Erstellungsdatum: 20.05.26 16:50

Überprüfen Sie das aktualisierte Dokument [klicken](#)



### TECHNISCHE DATEN

Mod.	MC104-R10
U	G1/4

## Druckregler - Serie MC

Produktcode: MC104-R10

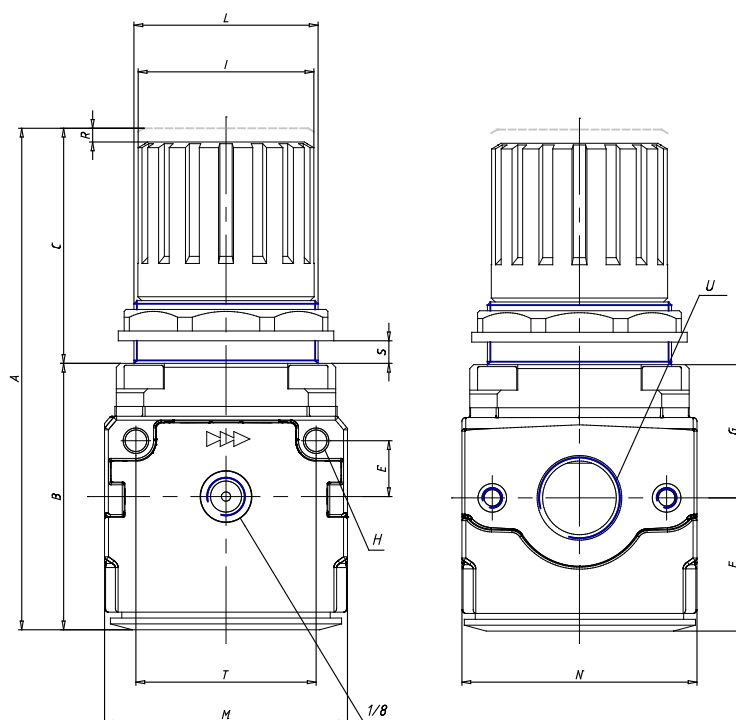

### MAßE

<b>A (mm)</b>	94
<b>B (mm)</b>	56
<b>C (mm)</b>	38
<b>E (mm)</b>	11
<b>F (mm)</b>	28.5
<b>G (mm)</b>	27.5
<b>H (mm)</b>	4.5
<b>I (mm)</b>	28
<b>leicht</b>	30x1.5
<b>M (mm)</b>	45
<b>N (mm)</b>	45
<b>R (mm)</b>	3.0
<b>S</b>	0:6
<b>T (mm)</b>	35