

Öler - Serie MX

Produktcode: MX2-3/4-L00

Datenblatt Erstellungsdatum: 20.05.26 16:50

Überprüfen Sie das aktualisierte Dokument  [klicken](#)



TECHNISCHE DATEN

Serie	MX
Größe	2
Anschluss (IN - OUT)	3/4 = G3/4
Öler	L
Bauart	00 = Nebelöler
Durchflussrichtung	= von links nach rechts (Standard)

Öler - Serie MX

Produktcode: MX2-3/4-L00

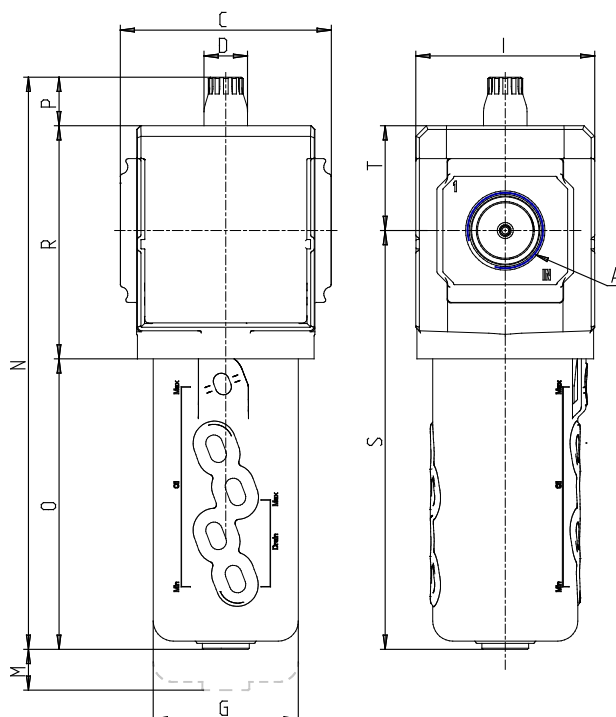

MAßE

A	G3/4
C (mm)	70.0
D (mm)	18.5
G (mm)	55.3
I (mm)	68
M (mm)	115
N (mm)	210
O (mm)	104.5
P (mm)	20.5
R (mm)	85
S (mm)	152
T (mm)	37.5
Gewicht (kg)	0.5