

Filterregler Serie N - Serie N

Produktcode: N104-D00-4

Datenblatt Erstellungsdatum: 21.05.26 01:24

Überprüfen Sie das aktualisierte Dokument [klicken](#)



TECHNISCHE DATEN

Mod.	N104-D00-4
R (mm)	3

Filterregler Serie N - Serie N

Produktcode: N104-D00-4

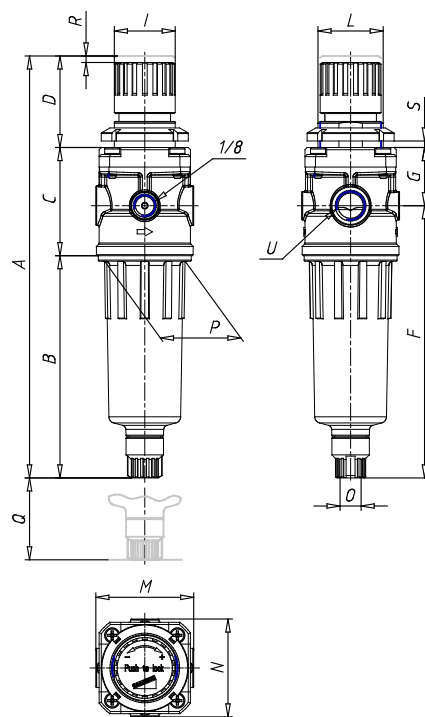

MAßE

A (mm)	167
Gewindelaenge (mm)	78
C (mm)	50
D (mm)	39
F (mm)	101
G (mm)	27
I (mm)	28
leicht	30x1.5
M (mm)	45
N (mm)	45
O	G1/8
P (mm)	38
Q (mm)	40
U	G1/4